

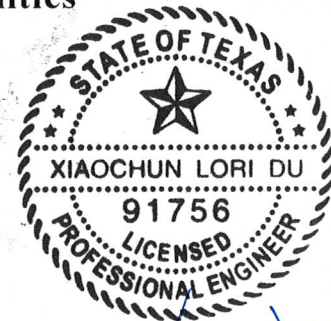

Davis Pressure Plane Phase 2

**CITY OF ARLINGTON
PROJECT NO. WUWS17001**



Department of Water Utilities

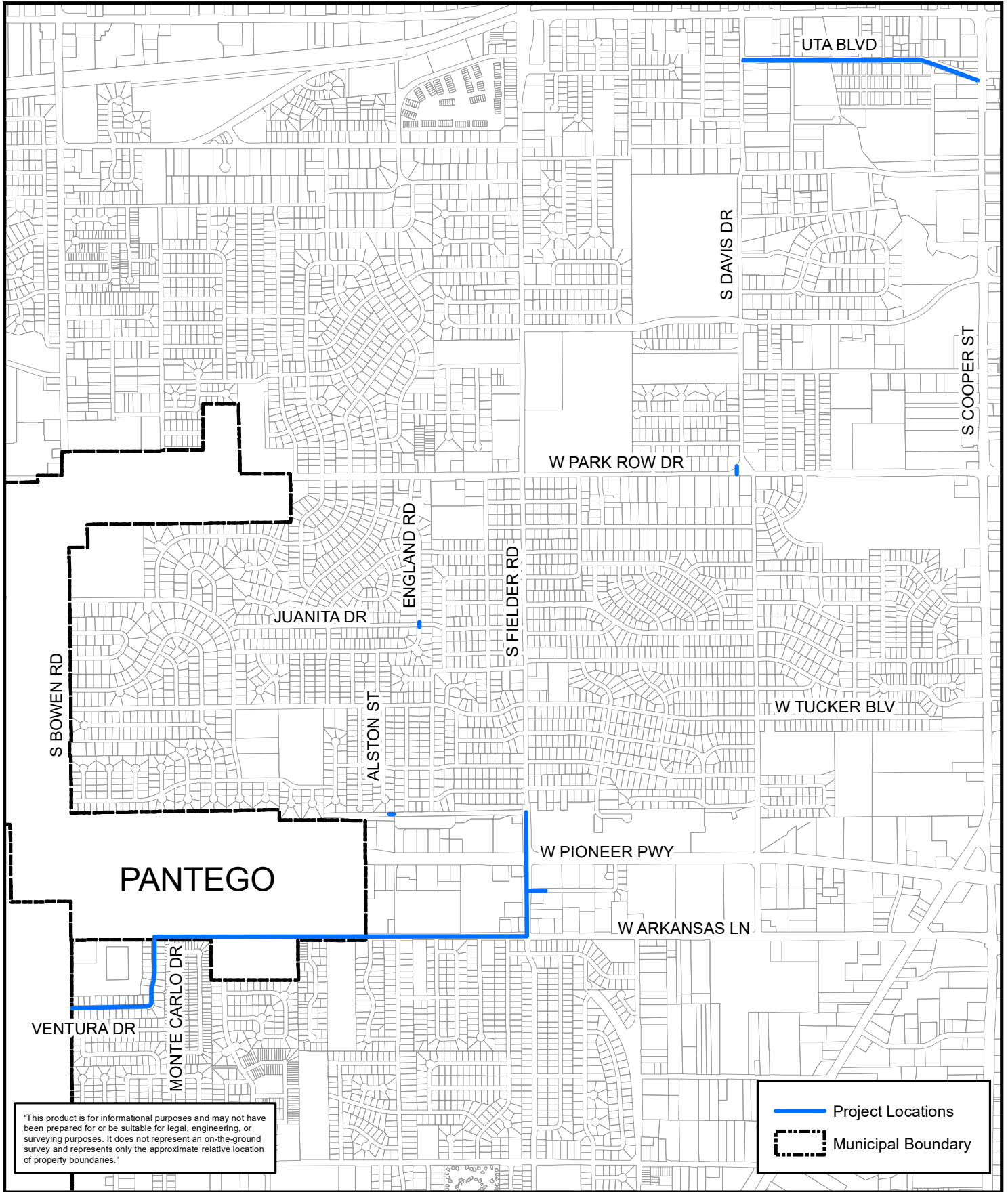

Lori Du
10/14/2021



"This product is for informational purposes and may not have been prepared for or be suitable for legal, engineering, or surveying purposes. It does not represent an on-the-ground survey and represents only the approximate relative location of property boundaries."

-  Project Locations
-  Municipal Boundary



Davis Pressure Plane Phase 2 Project No. WUWS17001



TABLE OF CONTENTS

<u>SECTION NUMBER</u>	<u>SUBJECT OF SECTION</u>
	Instructions to Bidders
1	Advertisement for Bids
2	Prevailing Wage Rates
3	Contractor Residency Statement
4	Affidavit Against Prohibited Acts
4A	Affidavit Against Firearm Entities
4B	Affidavit Against Boycotting Energy Companies
5	Verification Relating to Boycotting Israel
6	Proposal
7	Contract
8	Performance Bond
9	Payment Bond
10	Maintenance Bond
11	Special Provisions - General Administration Specifications
12	Special Provisions - General Construction Specifications
13	Special Provisions – Paving Specifications
14	Special Provisions – Water & Sanitary Sewer Specifications
15	Special Provisions – Drainage Specifications
16	Trench Safety and OSHA
17	Special Provisions – Landscaping Specifications
18	Special Provisions - Pavement Marking Specifications
19	Special Provisions – Streetlights Specifications
20	Special Provisions – Sign Specifications
21	Special Provisions – Signals Specifications
22	Special Provisions – Mill & Overlay/Reclamation Specifications

INSTRUCTIONS TO BIDDERS

1. **PROPOSAL FORM:** The Bidder may use the original proposal forms included in these bid documents or the Bidder may substitute a computer-generated proposal for the original proposal included in these bid documents. The Substitute Proposal shall also be signed by the Bidder. Any discrepancy in items between the Substitute Proposal and the original proposal form, the original proposal form shall govern. If the Substitute Proposal changes the intent of a bid item or contains an error in the quantities, unit prices, or extension of prices, the City may reject the bid submitted.

2. **DELIVERY OF PROPOSAL:** Proposal shall be delivered directly to the Office of the Director of Water Utilities, 2nd Floor, City Hall, 101 West Abram Street, Arlington TX, 76010. It shall be the Bidder's responsibility to ensure delivery of his/her proposal at the proper place by the time stated in the Notice to Bidders. The mere fact that a proposal was dispatched will not be considered. Any bids received after closing time will be returned unopened.

- **Each Proposal shall be in a sealed envelope plainly marked with the words "BID DOCUMENTS" or "BID PROPOSAL" with the name or description of the project as shown on the front cover of the Contract Documents.**
- **All bid items in the proposal including alternate and addendum items must be filled with a numeric value, including zero value. Bid items with blanks or dashes will be considered as non-responsive items and the bid will not be eligible for award consideration.**
- **The following MUST be included in the bid proposal otherwise the bid will be considered non-responsive and the bid will not be eligible for award consideration:**
 - *Certified or cashier's check or an approved bidder's bond*
 - *Signed Section 3 Contractor Residency Statement*
 - *Signed Acknowledgement/Acceptance of addendum(s) {last page of the addendum}, if applicable*
 - *MWBE Utilization Plan (MWBE certifications for each firm must be included), located at the end of INSTRUCTIONS TO BIDDERS*
- **All potential bidders MUST submit the following forms located at the end of INSTRUCTIONS TO BIDDERS to Lori Du, P. E., at Lori.Du@Arlingtontx.gov no later than 2:00 p.m. CDT, on Monday, November 22, 2021.**
 - *Letter of Intent as a Subcontractor (needed for each subcontractor)*
 - *Good Faith Effort Checklist (GFE) and supporting documentation*

Failure to submit the required MWBE documentation, based on the above listed time and date will result in the bid being considered non-responsive.

3. **MINORITY/WOMAN BUSINESS ENTERPRISE CONTRACT SPECIFIC GOAL:** The City's Minority/Woman Business Enterprise (MWBE) utilization goal, for this project is **24 %.**

Trades identified for this solicitation includes: **Water & Sanitary Sewer, Concrete Paving, Concrete, and Asphalt.**

The contractor's MWBE commitment percentage is based on the total value of the contract including any change orders and modifications throughout the contract agreement.

The criteria used to set a MWBE Contract Specific Goal shall include business availability, the nature of the contract, the City's past experiences with MWBE participation in similar contracts, price competitiveness, subcontracting opportunities, progress towards meeting the annual goal and other relevant factors.

4. PROCUREMENT OF GOODS AND SERVICES FROM MINORITY/WOMEN BUSINESS ENTERPRISE OR HISTORICALLY UNDERUTILIZED BUSINESSES:

It is the City's policy to remove all barriers for MWBEs to compete and create a level playing field for MWBEs to participate in City contracts and related subcontracts.

The Contractor specifically shall comply with all applicable provisions of the City's MWBE Policy and Procedures and any amendments. MWBE and non-MWBE subcontractors also agree to comply with all applicable provisions of the City's MWBE Policy and Procedures and any amendments. The City's MWBE Policy and Procedures and any amendments thereto are incorporated by reference herein as though written word for word. The Contractor shall insert the substance of this provision in all subcontracts and purchase orders.

The Contractor shall appoint a high-level official with decision-making capabilities for the Contractor to administer and coordinate the Contractor's efforts to carry out the requirements and provisions of the City's MWBE Policy and Procedures and its Contractual commitments.

The City of Arlington reaffirms that it will not, nor will its contractors, discriminate based on race, age, color, religion, sex, sexual orientation, gender identity, national origin, ancestry, gender, disability, or place of birth in the award and performance of contracts.

Every locally funded contract will be evaluated by the City to determine the appropriate method for enhancing MWBE participation, including progress towards the achievement of the annual aspirational MWBE goal and other program objectives.

Procedures for implementation, including good faith efforts requirements, information submitted with bid proposals, reporting procedures, etc., shall be consistent with the procedures utilized in the City's MWBE Policy & Procedures Manual.

The City will recognize MWBE companies that have received one or more certifications from the following organizations:

- North Central Texas Regional Certification Agency (NCTRCA),
- State of Texas Historically Underutilized Business (HUB),
- Texas Department of Transportation (TxDOT),
- DFW Minority Supplier Development Council (MSDC), and
- Woman's Business Council Southwest.

The City reserves the right to review, accept or reject any certification from agencies not listed.

In addition, the lowest responsible bidder will be required to submit cost information related to minority/woman businesses in accordance with Section 11-25.

5. PREQUALIFICATION OF BIDDERS: All Bidders on this project must be prequalified to perform **Water and Sanitary Sewer** work by the City of Arlington prior to the opening of bids. The successful contractor must perform this primary work type on this project. Bids received not in compliance with the prequalification requirements will not be opened.

Contractors performing the following work types must also be prequalified:

Asphalt Paving
Concrete Paving
Subgrade Preparation

The lowest responsible bidder will be required to submit a list of subcontractors and the type of work they will be performing to verify status of prequalification. If the required prequalification is not met, the lowest responsible bidder will be required to provide a substitute prequalified subcontractor or the bid will be rejected. Application for prequalification of subcontractors will not be accepted after the bid is opened. However, should there be a change in project scope during construction the City reserves the right to require additional prequalification of contractor(s) performing the work.

For information related to prequalification status, please contact the Department of Public Works and Transportation. To obtain prequalification status, application forms must be completed and returned to the Department of Public Works and Transportation. Processing time varies and may take up to three weeks to process. The mere fact that an application was submitted does not guarantee or constitute approval of prequalification status.

6. BID SECURITY: Each bid must be accompanied by a certified or cashier's check or an approved bidder's bond made payable to the City in an amount of five (5%) percent of the largest possible total of the bid as a guarantee that, if awarded the contract, the Bidder will enter into a Contract and execute all necessary bonds.

7. PERFORMANCE, PAYMENT AND MAINTENANCE BONDS: Performance, payment and maintenance bonds in the amount of not less than one hundred percent (100%) of the contract price conditioned upon the faithful performance of the contract, and upon payment of all persons supplying labor or furnishing materials, will be required upon the forms which are a part of the Contract Documents. Bonds shall be executed by a surety company acceptable to and approved by the City, authorized to do business in the State of Texas and acceptable for underwriting of risks as indicated by the latest revision, Treasury Department Circular 570, listing acceptable sureties on Federal Bonds. The period of the Maintenance Bond shall be two years from the date of acceptance of all work done under the Contract, to cover the guarantee as set forth in the Special Provisions.

8. BIDDERS KNOWLEDGE OF CONDITIONS: Prior to submission of a proposal, bidders shall have made a thorough inspection of the site of work and a thorough examination of the plans and specifications and shall become informed as to the nature of the work, labor conditions, and all other matters that may affect the cost and time of completion of the work.

9. INTERPRETATION OF DOCUMENT: If any person contemplating submitting a bid is in doubt as to the meaning of any part of the plans, specifications, or other proposed contract documents, the person shall email the engineer for an interpretation. **Inquiries received seven (7) business days or less prior to opening of bids may not be entertained.** The person making the

inquiry or request for additional information will be responsible for its prompt delivery. The City cannot guarantee a response if the inquiry or request is not submitted in time. Any interpretation of these documents will be made by addendum duly issued. The City will not be responsible for any other explanations or interpretations.

10. SOIL INVESTIGATION: Soil report was not performed for this project.

11. ALTERNATE BIDS: No bids for alternate work items shall be submitted except as shown on the Proposal. The City reserves the right to choose either the base bid or alternate bid whichever is most advantageous to the City. There will be no adjustments to unit prices bid due to the City's choice of alternate bids.

12. ADDENDUM: The City reserves the right to issue addendum(s) to the Plans, Proposal, Specifications, and Special Provisions. Addendum(s) will be issued via the City's supplier/vendor portal, IonWave, located on the City's web page. Bidders who are currently registered with IonWave will be notified via the portal notification process and the addendum(s) may be downloaded by logging into the portal. **It shall be the Bidder's responsibility to ensure that he/she is aware of any and all addendum(s) issued by the City.**

13. AWARD OF CONTRACT: As allowed by law, the Contract shall be awarded to the bidder whose bid represents the lowest responsible bid as determined by the City.

It is the intent of the City of Arlington that this project be completed as quickly and economically as is feasible. A tabulation of the bids received will be prepared for consideration by the City Council. It is anticipated that the BEGIN WORK DATE will be approximately two months after the date of bid opening.

14. BID TABULATION: A tabulation of all bids will be available within five (5) working days of the bid opening on City's web page, https://www.arlingtontx.gov/city_hall/departments/finance/purchasing/bidding_procurement, under "Current Bid Opportunities", "Water Utilities".

15. AFFIDAVIT AGAINST PROHIBITED ACTS: It shall be the lowest responsible bidder's responsibility to complete this affidavit (Sections 4, 4A and 4B of the Contract Documents) prior to execution of the contract by the City of Arlington. Failure to complete this form may prohibit the Contractor's ability to secure the contract.

16. TITLE VI: The City of Arlington, in accordance with Title VI of the Civil Rights Act of 1964, 78 Stat. 252, 42 U.S.C. 2000d to 2000d-4 and Title 49, Code of Federal Regulations, Department of Transportation, Subtitle A, Office of the Secretary, Part 21, Nondiscrimination in Federally-Assisted programs of the Department of Transportation issued pursuant to such Act, hereby notifies all vendors that it will affirmatively ensure that in any contract entered into pursuant to this advertisement, minority business enterprises will be afforded full opportunity to submit bids in response to this invitation and will not be discriminated against on the grounds of race, color, or national origin in consideration for an award. Vendor will abide and ensure compliance with all terms of Appendix A of the USDOT Standard Title VI Assurances as listed below.

Appendix A of the USDOT Standard Title VI Assurances

During the performance of this contract, the Contractor, for itself, its assignees and successors in interest (hereinafter referred to as the "Contractor") agrees as follows:

(1) Compliance with Regulations: The Contractor shall comply with the Regulations relative to nondiscrimination in Federally-Assisted programs of the Department of Transportation

(hereinafter, "DOT") Title 49, Code of Federal Regulations, Part 21, as they may be amended from time to time, (hereinafter referred to as the Regulations), which are herein incorporated by reference and made a part of this contract.

(2) Nondiscrimination: The Contractor, with regard to the work performed by it during the contract, shall not discriminate on the grounds of race, color, or national origin in the selection and retention of subcontractors, including procurements of materials and leases of equipment. The Contractor shall not participate either directly or indirectly in the discrimination prohibited by section 21.5 of the Regulations, including employment practices when the contract covers a program set forth in Appendix B of the Regulations.

(3) Solicitations for Subcontracts, Including Procurements of Materials and Equipment: In all solicitations either by competitive bidding or negotiation made by the Contractor for work to be performed under a subcontract, including procurements of materials or leases of equipment, each potential subcontractor or supplier shall be notified by the Contractor of the Contractor's obligations under this contract and the Regulations relative to nondiscrimination on the grounds of race, color, or national origin.

(4) Information and Reports: The Contractor shall provide all information and reports required by the Regulations or directives issued pursuant thereto, and shall permit access to its books, records, accounts, other sources of information, and its facilities as may be determined by the City of Arlington or the Texas Department of Transportation to be pertinent to ascertain compliance with such Regulations, orders and instructions. Where any information required of a Contractor is in the exclusive possession of another who fails or refuses to furnish this information the Contractor shall so certify to the City of Arlington, or the Texas Department of Transportation as appropriate, and shall set forth what efforts it has made to obtain the information.

(5) Sanctions for Noncompliance: In the event of the Contractor's noncompliance with the nondiscrimination provisions of this contract, the City of Arlington shall impose such contract sanctions as it or the Texas Department of Transportation may determine to be appropriate, including, but not limited to:

- (a) withholding of payments to the Contractor under the contract until the Contractor complies, and/or
- (b) cancellation, termination or suspension of the contract, in whole or in part.

(6) Incorporation of Provisions: The Contractor shall include the provisions of paragraphs (1) through (6) in every subcontract, including procurements of materials and leases of equipment, unless exempt by the Regulations, or directives issued pursuant thereto.

The Contractor shall take such action with respect to any subcontract or procurement as the City of Arlington or the Texas Department of Transportation may direct as a means of enforcing such provisions including sanctions for non-compliance: Provided, however, that, in the event a Contractor becomes involved in, or is threatened with, litigation with a subcontractor or supplier as a result of such direction, the Contractor may request the City of Arlington to enter into such litigation to protect the interests of the City of Arlington, and, in addition, the Contractor may request the United States to enter into such litigation to protect the interests of the United States.

17. FORM 1295: Effective January 1, 2016, the Texas Legislature, House Bill 1295 requires all business entity to file an electronic disclosure of interested parties (Form 1295) to the Texas Ethic Commission (TEC) for any contracts requiring City Council approval. The lowest responsible bidder will be required to file online with TEC at <https://www.ethics.state.tx.us/filinginfo/1295/>. The responsible bidder will be required to swear or affirm that the information entered is true and correct. An original signed copy of the filing must be submitted to the City prior to approval of the contract by City Council. **Failure to submit**

Form 1295 prior to date of City Council's approval will result in the contracts not being processed.

Definition of "Interested Party" is located under Laws & Regulations, Chapter 46, Commission Rules; Disclosure of Interested Parties. FAQ's for Form 1295 can be found on https://www.ethics.state.tx.us/resources/FAQs/FAQ_Form1295.php.

18. VERIFICATION RELATING TO BOYCOTTING ISRAEL: New State legislation, Chapter 2270 of the Texas Government Code prevents the City of Arlington from entering a contract that boycotts Israel. The successful contractor must verify they do not and will not boycott Israel during term of this contract. It shall be the lowest responsible bidder's responsibility to complete this verification (Section 5 of the Contract Documents) prior to execution of the contract by the City of Arlington. Failure to complete this form will prohibit the contractor's ability to secure the contract.

19. VERIFICATION RELATING TO ENERGY BOYCOTT: New State legislation, Chapter 2274 of the Texas Government Code prohibits a city from entering into a contract with a value of \$100,000 or more that is to be paid from public funds with a company with more than 10 full-time employees for goods or services unless the contract contains a written verification from the company that it: (1) does not boycott energy companies; and (2) will not boycott energy companies during the term of the contract. It shall be the lowest responsible bidder's responsibility to complete this verification (Section 4A of the Contract Documents) prior to execution of the contract by the City of Arlington. Failure to complete this form will prohibit the contractor's ability to secure the contract.

20. VERIFICATION RELATING TO FIREARMS BOYCOTT: New State legislation, Chapter 2274 of the Texas Government Code (1) prohibits a governmental entity from entering into a contract with a value of \$100,000 or more that is to be paid from public funds with a company with more than 10 full-time employees for the purchase of goods or services unless the contract contains a written verification from the company that it: (a) does not have a practice, policy, guidance, or directive that discriminates against a firearm entity or firearm trade association; and (b) will not discriminate during the term of the contract against a firearm entity or firearm trade association; and (2) provides that the prohibition in (1) does not apply to a city that (a) contracts with a sole-source provider, or (b) the city does not receive any bids from a company that is able to provide the required verification required by (1). It shall be the lowest responsible bidder's responsibility to complete this verification (Section 4B of the Contract Documents) prior to execution of the contract by the City of Arlington. Failure to complete this form will prohibit the contractor's ability to secure the contract.

21. PROCUREMENT OF GOODS AND SERVICES FROM ARLINGTON BUSINESSES: In performing this contract, Contractor agrees to use diligent efforts to purchase all goods and services from Arlington Businesses whenever such goods and services are comparable in availability, quality and price.

Note: Pipeline crossings of all potential waters of the United States under the jurisdiction of the United States Army Corps of Engineers, will be performed in compliance with Nationwide Permit 12 – Utility Line Activities.

END OF SECTION



Office of Business Diversity

MWBE UTILIZATION PLAN

Project Name _____

Project No: _____ Date: _____

LEGEND

MWBE = Minority/Woman Business Enterprise

* Ethnicity = Native American (AI), Asian Pacific/Indian (AS), African American (BL), Hispanic (HI), Caucasian Female (WO), or Non- Minority (N/A)

Prime Contractor	MWBE (Yes/No)

LIST ALL SUBCONTRACTING OPPORTUNITIES (use additional sheets if necessary):

Name of Company and Description of Work Type	Potential MWBE Firm Ethnicity* (Yes/No)	Anticipated Dollar (\$) of Work

Please complete this form and include with proposal, as an attachment.

Upon formal award of said project, the proposer will submit a Prime, Subs & MWBE Report identifying the Local and/or MWBE subcontractor(s) that will perform the listed work. By signing below, the recommended proposer shall agree to meet their Local and/or MWBE goal based on the information provided on this document.

Name of Company's Main Contact Person _____

Signature of Main Contact Person _____



MINORITY/WOMEN BUSINESS ENTERPRISE (MWBE)

Minority and/or Woman-owned Business Enterprises are encouraged to participate in all City procurement solicitation. In order to be identified as a certified Minority/Woman Business Enterprise with the City of Arlington, Texas; this form, along with a copy of the selected certification, should be included with the bid/proposal.

PLEASE CHECK THE APPROPRIATE ETHNICITY AND/OR GENDER:

American Indian Asian Black Hispanic Woman Owned

Certification Status: Is the firm certified as a Minority, Woman, or Disadvantaged Business Enterprise by a government or business development agency? Yes No (If yes, please select specific agency)

North Central Texas Regional Certification Agency (NCTRCA)

State of Texas Historically Underutilized Business (HUB)

Dallas/Fort Worth Minority Supplier Development Council (DFW MSDC) or NMSDC affiliate

Women’s Business Council – Southwest (WBC-SW) or WBENC affiliate

Texas Department of Transportation, Disadvantaged Business Enterprise (TxDOT, DBE)

Small Business Administration, 8(A) Program

Other (please specify) _____

The City of Arlington encourages minority participation and utilizing MWBE subconsultants where there are opportunities on this project.

For City Use Only:

I have reviewed this Utilization Plan and found that the _____ **HAS** or **HAS NOT** complied as per the City’s M/WBE Special Provisions.

Verified Goal attainment:

MBE ____% WBE ____%

Reviewer

Date:



Office of Business Diversity

LETTER OF INTENT TO SUBCONTRACT

Project Number: _____

Project Title: _____

_____ (“Prime Contractor”) agrees to enter into a contractual agreement with _____ (“MWBE Subcontractor”), who will provide the following goods/services on the above-referenced contract.

(Use broad categories (ex. “electrical work”, “HVAC equipment purchase”, etc.) to describe the goods/services to be provided).

for an estimated amount of \$ _____ or _____ of the total estimated contract value.

Prime Contractor agrees to utilize said MWBE Subcontractor in the capacity indicated herein and MWBE Subcontractor agrees to work on the above-referenced contract in the capacity herein, contingent upon award of the contract to Prime Contractor.

Signature – Prime Contractor

Signature – MWBE Subcontractor

Print Name

Print Name

Title

Date

Title

Date

Office of Business Diversity

Good Faith Effort Checklist



In making a determination that the contractor has made a good-faith effort to meet the City's MWBE goals, the Office of Business Diversity shall consider specific documentation concerning the steps taken to obtain MWBE participation, with a consideration of the following factors:

If a contractor fails to submit the Good Faith Efforts checklist, with document, by the deadline for submission will be considered non-responsive.

- Contractor attended the City's pre-bid or pre-proposal meeting.
- Contractor advertised in general circulation, trade association, and/or MWBE-focused media regarding subcontracting and/or supplier opportunities.
- Contractor solicited through reasonable and available means (e.g., written notices, advertisements) M/WBEs certified in the anticipated scopes of subcontracting of the contract, within sufficient time to allow them to respond. Attach detailed Contacts Log, including date, method of contact, person contacted and contact information, and the result of the contact.
- Contractor selected those portions of the contract consistent with the available M/WBEs, including breaking down the work into economically feasible units to facilitate M/WBE participation even when the proposer would prefer to perform those scopes with its own forces. Provide description of work selected.
- Contractor provided timely and adequate information about plans, specifications, scope of work and contract requirements to interested MWBEs. Followed up initial solicitations to answer questions and encourage M/WBEs to submit proposals or bids. Attach evidence of information provided, including the date, e.g., letters, emails, telephone logs, etc.
- Contractor negotiated in good-faith with interested MWBEs that have submitted proposals or bids and thoroughly investigated their capabilities, using good business judgement, and taking into consideration the MWBE subcontractor's price quote and not rejecting reasonable quotes from interested MWBE. Evidence of such negotiations includes the names, addresses, email addresses and telephone numbers of M/WBEs with whom the vendor negotiated; a description of the information provided to M/WBEs regarding the work selected for subcontracting; and explanations as to why agreements could not be reached with M/WBEs to perform the work.
- Contractor made effort to assist interested MWBEs to obtain bonding, lines of credit, or insurance as required by the City or the vendor for performance of the contract (if applicable).
- Contractor effectively utilized the services of M/WBE assistance groups; local, state, and federal M/WBE business assistance offices and other organizations that provide assistance in the recruitment and placement of MWBEs.

Signature Prime Contractor:

Print Name:

Title

Date:

SECTION NO. 1

ADVERTISEMENT FOR BIDS

This project primarily consists of installing approximately 7,500 linear feet of 16-inch PVC water main. The Engineer's estimate for this project is \$5,980,000.

Sealed bids will be received by the City of Arlington, Texas, at the Office of the Director of Water Utilities, 2nd Floor, City Hall, 101 W. Abram Street, Arlington TX, 76010, **until 2 p.m. on Thursday, November 18, 2021** for the construction of **Davis Pressure Plane Phase 2, PROJECT NO. WUWS17001** as listed in the contract documents, at which time and place they will be publicly opened and read aloud in the Public Works Conference Room / lobby area where social distancing will be maintained. Any bid received after closing time will be returned unopened.

All bidders and subcontractors on this project must be pre-qualified in the appropriate work category as outlined in the Instructions to Bidders of the contract documents.

Contract documents, including plans, specifications, and addendums may be reviewed and/or downloaded from the City's vendor/supplier portal, IonWave, accessible via the City's web page, https://arlingtontx.gov/city_hall/departments/finance. Look for "Vendor/Supplier" under "Services".

A cashier's check or an acceptable Bidder's Bond payable to the City of Arlington, Texas, in an amount of not less than five percent (5%) of the largest possible total for the bid submitted, must accompany the bid.

A Performance Bond and a Payment Bond, each for one hundred percent (100%) of the contract price, will be required. The successful bidder shall also furnish to the City a Maintenance Bond covering defects of material and workmanship for two calendar years following the City's approval and acceptance of the construction.

Not less than the prevailing wage rates adopted by the City of Arlington, Texas, and as set forth in the contract documents, must be paid on this project.

The City reserves the right to request bidders to provide Minority/Women Business Enterprises (MWBE) information. This is for information only and no preference shall be given, nor will this information affect the results of the contract award.

In case of ambiguity or lack of clearness in stating prices in the Proposal, the City reserves the right to accept the most advantageous construction thereof to the City or to reject the proposal.

The City reserves the right to reject any or all bids and waive any or all informalities. No bid may be withdrawn until the expiration of ninety (90) days from the date bids are opened.

All inquiries must be submitted to the City in accordance with the Instructions to Bidders of the contract documents.

A PRE-BID MEETING (not mandatory) will be held for this project on **Thursday, November 4, 2021 at 2 p.m.** in the Public Works and Transportation Conference Room, 2nd Floor, City Hall, 101 W. Abram Street, Arlington, TX 76010.

If you have any questions concerning this project, please contact Lori Du, P.E., Water Utilities/Engineering, City of Arlington, at (817) 459-6636 or email at Lori.Du@Arlingtontx.gov.

Arlington Star-Telegram publication dates: Wednesday, 10/27/2021 & Wednesday, 11/3/2021

CONTRACTOR STATUS INFORMATION

Instructions: Please fill in the appropriate section below, completing all blanks within the section. This information is necessary to ensure that the contract and bonds are in the correct form.

SECTION 1: If the contractor is a sole proprietor, fill in this section only:

Name: _____
 First Middle Last

Name under which you are engaged in business (if operating under an assumed name):

Residence: _____
 Street City County State ZIP

Business: _____
 Street City County State ZIP

Principal place of business: _____
 City County State ZIP

Contact Person: _____
 Name Phone Email Address

SECTION 2: If the contractor is a partnership, fill in this section only:

Name of Partner: _____
 First Middle Last

Residence: _____
 Street City County State ZIP

Name of Partner: _____
 First Middle Last

Residence: _____
 Street City County State ZIP

Name under which contractor conducts business (if operating under an assumed name):

Business Address: _____
 Street City County State ZIP

Principal place of business: _____
City County State Zip

Contact Person: _____
Name Phone Email Address

SECTION 3: If the contractor is a corporation, fill in this section only:

Registered name of corporation: _____

Doing business as: _____

Date charter expires: _____

State of corporation: _____

Date of corporation filing: _____ (If non-Texas corporation, date of Certificate of Authority Issuance).

Registered Agent: _____
First Middle Last

Address: _____
Street City County State ZIP

Location of Corporation principal office:

Street City County State ZIP

Person executing contract on behalf of corporation: (Please print)

Name: _____
First Middle Last

Title: _____

Address: _____
Street City County State ZIP

Telephone Number: _____

Contact Person: _____
Name Phone Email Address

END OF SECTION

SECTION NO. 2

PREVAILING WAGE RATES

"General Decision Number: TX20210026 01/01/2021

Superseded General Decision Number: TX20200026

State: Texas

Construction Type: Heavy

Counties: Johnson, Parker and Tarrant Counties in Texas.

Heavy Construction Projects (Including Water and Sewer Lines)

Note: Under Executive Order (EO) 13658, an hourly minimum wage of \$10.95 for calendar year 2021 applies to all contracts subject to the Davis-Bacon Act for which the contract is awarded (and any solicitation was issued) on or after January 1, 2015. If this contract is covered by the EO, the contractor must pay all workers in any classification listed on this wage determination at least \$10.95 per hour (or the applicable wage rate listed on this wage determination, if it is higher) for all hours spent performing on the contract in calendar year 2021. If this contract is covered by the EO and a classification considered necessary for performance of work on the contract does not appear on this wage determination, the contractor must pay workers in that classification at least the wage rate determined through the conformance process set forth in 29 CFR 5.5(a)(1)(ii) (or the EO minimum wage rate, if it is higher than the conformed wage rate). The EO minimum wage rate will be adjusted annually. Please note that this EO applies to the above-mentioned types of contracts entered into by the federal government that are subject to the Davis-Bacon Act itself, but it does not apply to contracts subject only to the Davis-Bacon Related Acts, including those set forth at 29 CFR 5.1(a)(2)-(60). Additional information on contractor requirements and worker protections under the EO is available at www.dol.gov/whd/govcontracts.

Modification Number	Publication Date
0	01/01/2021

* PLUM0146-002 11/01/2020

	Rates	Fringes
PLUMBER/PIPEFITTER.....	\$ 32.93	9.70
SUTX1990-041 06/01/1990		

	Rates	Fringes
CARPENTER.....	\$ 10.40	\$3.64
Concrete Finisher.....	\$ 9.81	

ELECTRICIAN.....	\$ 13.26	
Form Setter.....	\$ 7.86	
Laborers:		
Common.....	\$ 7.25	
Utility.....	\$ 8.09	
PAINTER.....	\$ 10.89	
Pipelayer.....	\$ 8.43	
Power equipment operators:		
Backhoe.....	\$ 11.89	3.30
Bulldozer.....	\$ 10.76	
Crane.....	\$ 13.16	3.30
Front End Loader.....	\$ 10.54	
Mechanic.....	\$ 10.93	
Scraper.....	\$ 10.00	
Reinforcing Steel Setter.....	\$ 10.64	
TRUCK DRIVER.....	\$ 7.34	

WELDERS - Receive rate prescribed for craft performing operation to which welding is incidental.

THE STATE OF TEXAS §
COUNTY OF _____ §

AFFIDAVIT

BEFORE ME, the undersigned authority, a Notary Public in and for the State of Texas, on this day personally appeared _____, who is known to me or who was proved to me on the oath of _____ (name of person identifying the acknowledging person) or who was proved to me through _____ (description of identity card or other document issued by the federal or state government containing the picture and signature of the acknowledging person) to be the person whose name is subscribed to this affidavit; and being by me first duly sworn, upon oath stated as follows:

"My name is _____. I am of sound mind and capable of making this affidavit.

"I am _____ for _____, which company entered into a contract on the ___ day of _____, 20__, to construct **Davis Pressure Plane Phase 2**, City of Arlington Project No. **WUWS17001**, in the City of Arlington, Texas, and I am duly authorized on behalf of said company to hereby swear and affirm that all wages for labor on the above-referenced project are in strict compliance with the established prevailing wage rates as described in the contract documents for the referenced project, and all wages have been and will be paid and satisfied as the prevailing rates may change from time to time. Upon request by the City of Arlington, I shall allow a complete examination of the financial records relative to this project, including, but not limited to, cancelled checks, invoices and statements at any time, and allow the City of Arlington to interview any and/or all employees of the above said company or any and/or all employees of said Company's subcontractor or subcontractors. Also, I hereby agree on behalf of the above company, to be accountable for any and all penalties and/or fine provisions in accordance with the contract documents and relevant law."

AFFIANT

GIVEN UNDER MY HAND AND SEAL OF OFFICE this the _____ day of _____, 20_____.

Notary Public In and For The State of Texas

Notary's Printed Name

END OF SECTION

SECTION NO. 3

CONTRACTOR RESIDENCY STATEMENT

The Texas Government Code section 2252.002 governs the awarding of contracts to non-resident bidders. This law provides that, in order to be awarded a contract as low bidder, a non-resident bidder (out-of-state contractor whose corporate office or principal place of business is outside the State of Texas) bid projects in Texas at an amount lower than the lowest Texas resident bidder by the same amount that a Texas resident bidder would be required to underbid a non-resident bidder in order to obtain a comparable contract in the state in which the non-resident's principal place of business is located. The appropriate blanks in the following statement **must** be filled out by all out-of-state or non-resident bidders in order for those bids to meet specifications. The failure of out-of-state or non-resident contractors to do so will automatically disqualify that bidder. This does not apply to contracts involving Federal Funds.

Initial here if you are **Texas Residential Bidder**.

Initial here if you are a **Non-resident contractor** in _____ (give state), our principal place of business, is required to be _____ percent lower than resident bidders by State Law.

BIDDER

Company

By _____
(Please Print)

Address

Signature

City State Zip

Title (Please Print)

*The **State Purchasing and General Services Commission** defines Principal Place of Business as follows: Principal Place of Business in Texas means, for any type of business entity recognized in the **State of Texas**, that the business entity:

- has at least one permanent office located in the **State of Texas**, from which business activities other than submitting bids to governmental agencies are conducted and from which the bid is submitted, and
- has at least one employee who works in the Texas office

*The **Texas Comptroller** annually publishes a list showing how each state regulates the award if governmental contracts whose principal place of business is not located in that state.

<http://comptroller.texas.gov/>

END OF SECTION
Revised 9/2016

SECTION NO. 4

AFFIDAVIT AGAINST PROHIBITED ACTS

I hereby affirm that I am aware of the provisions of the Texas Penal Code Sec. 36.02, 36.08, 36.09, and 36.10 (a copy of which follows), dealing with Bribery and Gifts to Public Servants. I further affirm that I will adhere to such rules and instruct and require all agents, employees, and sub-contractors to do the same. I am further aware that any violation of these rules subjects this agreement to revocation, my removal from bid lists, prohibiting future contract/subcontract work, revocation of permits, and prosecution.

Signature

Date

ATTEST (if corporation)

Date

TEXAS PENAL CODE

TITLE 8: OFFENSES AGAINST PUBLIC ADMINISTRATION

CHAPTER 36. Bribery and Corrupt Influence

36.02 Bribery

- (a) A person commits an offense if he intentionally or knowingly offers, confers, or agrees to confer on another, or solicits, accepts, or agrees to accept from another:
 - (1) any benefit as consideration for the recipient's decision, opinion, recommendation, vote, or other exercise of discretion as a public servant, party official, or voter;
 - (2) any benefit as consideration for the recipient's decision, vote, recommendation, or other exercise of official discretion in a judicial or administrative proceeding;
 - (3) any benefit as consideration for a violation of a duty imposed by law on a public servant or party official; or
 - (4) any benefit that is a political contribution as defined by Title 15, Election Code, or that is an expenditure made and reported in accordance with Chapter 305, Government Code, if the benefit was offered, conferred, solicited, accepted, or agreed to pursuant to an express agreement to take or withhold a specific exercise of official discretion if such exercise of official discretion would not have been taken or withheld but for the benefit; notwithstanding any rule of evidence or jury instruction allowing factual inferences in the absence of certain evidence, direct evidence of the express agreement shall be required in any prosecution under this subdivision.
- (b) It is no defense to prosecution under this section that a person whom the actor sought to influence was not qualified to act in the desired way whether because he had not yet assumed office or he lacked jurisdiction or for any other reason.
- (c) It is no defense to prosecution under this section that the benefit is not offered or conferred or that the benefit is not solicited or accepted until after:
 - (1) the decision, opinion, recommendation, vote, or other exercise of discretion has occurred; or
 - (2) the public servant ceases to be a public servant.
- (d) It is an exception to the application of Subdivisions (1), (2), and (3) of Subsection (a) that the benefit is a political contribution as defined by Title 15, Election Code, or an expenditure made and reported in accordance with Chapter 305, Government Code.
- (e) An offense under this section is a felony of the second degree.

36.08 Gift to Public Servant by Person Subject to His Jurisdiction

- (a) A public servant in an agency performing regulatory functions or conducting inspections or investigations commits an offense if he solicits, accepts, or agrees to accept any benefit

from a person the public servant knows to be subject to regulation, inspection, or investigation by the public servant or his agency.

- (b) A public servant in an agency having custody of prisoners commits an offense if he solicits, accepts, or agrees to accept any benefit from a person the public servant knows to be in his custody or the custody of his agency.
- (c) A public servant in an agency carrying on civil or criminal litigation on behalf of government commits an offense if he solicits, accepts, or agrees to accept any benefit from a person against whom the public servant knows litigation is pending or contemplated by the public servant or his agency.
- (d) A public servant who exercises discretion in connection with contracts, purchases, payments, claims, or other pecuniary transactions of government commits an offense if he solicits, accepts, or agrees to accept any benefit from a person the public servant knows is interested in or likely to become interested in any contract, purchase, payment, claim, or transaction involving the exercise of his discretion.
- (e) A public servant who has judicial or administrative authority, who is employed by or in a tribunal having judicial or administrative authority, or who participates in the enforcement of the tribunal's decision, commits an offense if he solicits, accepts, or agrees to accept any benefit from a person the public servant knows is interested in or likely to become interested in any matter before the public servant or tribunal.
- (f) A member of the legislature, the governor, the lieutenant governor, or a person employed by a member of the legislature, the governor, the lieutenant governor, or an agency of the legislature commits an offense if he solicits, accepts, or agrees to accept any benefit from any person.
- (g) A public servant who is a hearing examiner employed by an agency performing regulatory functions and who conducts hearings in contested cases commits an offense if the public servant solicits, accepts, or agrees to accept any benefit from any person who is appearing before the agency in a contested case, who is doing business with the agency, or who the public servant knows is interested in any matter before the public servant. The exception provided by Sec. 36.10(b) does not apply to a benefit under this subsection.
- (h) An offense under this section is a Class A misdemeanor.
- (i) A public servant who receives an unsolicited benefit that the public servant is prohibited from accepting under this section may donate the benefit to a governmental entity that has the authority to accept the gift or may donate the benefit to a recognized tax-exempt charitable organization formed for educational, religious, or scientific purposes.

36.09 Offering Gift to Public Servant

- (a) A person commits an offense if he offers, confers or agrees to confer any benefit on a public servant that he knows the public servant is prohibited by law from accepting.
- (b) An offense under this section is a Class A misdemeanor.

36.10 Non-Applicable

- (a) Sections 36.08 (Gift to Public Servant) and 36.09 (Offering Gift to Public Servant) do not apply to:
 - (1) a fee prescribed by law to be received by a public servant or any other benefit to which the public servant is lawfully entitled or for which he gives legitimate consideration in a capacity other than as a public servant;
 - (2) a gift or other benefit conferred on account of kinship or a personal, professional, or business relationship independent of the official status of the recipient; or
 - (3) a benefit to a public servant required to file a statement under Chapter 572, Government Code, or a report under Title 15, Election Code, that is derived from a function in honor or appreciation of the recipient if:
 - (A) the benefit and the source of any benefit in excess of \$50 is reported in the statement; and
 - (B) the benefit is used solely to defray the expenses that accrue in the performance of duties or activities in connection with the office which are nonreimbursable by the state or political subdivision;
 - (4) a political contribution as defined by Title 15, Election Code;
 - (5) a gift, award, or memento to a member of the legislative or executive branch that is required to be reported under Chapter 305, Government Code;
 - (6) an item with a value of less than \$50, excluding cash or a negotiable instrument as described by Section 3.104, Business & Commerce Code; or
 - (7) an item issued by a governmental entity that allows the use of property or facilities owned, leased, or operated by the governmental entity.
- (b) Section 36.08 (Gift to Public Servant) does not apply to food, lodging, transportation, or entertainment accepted as a guest and, if the donee is required by law to report those items, reported by the donee in accordance with that law.
- (c) Section 36.09 (Offering Gift to Public Servant) does not apply to food, lodging, transportation, or entertainment accepted as a guest and, if the donor is required by law to report those items, reported by the donor in accordance with that law.
- (d) Section 36.08 (Gift to Public Servant) does not apply to a gratuity accepted and reported in accordance with Section 11.0262, Parks and Wildlife Code. Section 36.09 (Offering Gift to Public Servant) does not apply to a gratuity that is offered in accordance with Section 11.0262, Parks and Wildlife Code.

END OF SECTION

SECTION NO. 4A

**VERIFICATION RELATING TO DISCRIMINATING AGAINST FIREARM OR
AMMUNITION INDUSTRIES**

The State of Texas has passed legislation, which is codified in Chapter 2274 of the Texas Government Code, that prevents any municipal government from entering into a contract for goods and services unless the contractor makes certain verifications. The Contractor, by signing below, verifies that Contractor does not have a practice, policy, guidance, or directive that discriminates against a firearm entity or firearm trade association, and that it will not discriminate against a firearm entity or firearm trade association during the term of this Contract. This verification, when executed, will be attached to the contract and become a part of the contract for all purposes. This verification relates to the contract for **Davis Pressure Plane Phase 2**, City of Arlington project No. **WUWS17001**.

BY: _____

Name: _____

Title: _____

Witness:

Signature

Name

Title

END OF SECTION

SECTION NO. 4B

VERIFICATION RELATING TO BOYCOTTING ENERGY COMPANIES

The State of Texas has passed legislation, which is codified in Chapter 2274 of the Texas Government Code, that prevents any municipal government from entering into a contract for goods and services unless the contractor makes certain verifications. The Contractor, by signing below, verifies that Contractor does not boycott energy companies and will not boycott energy companies during the term of the Contract. This verification, when executed, will be attached to the contract and become a part of the contract for all purposes. This verification relates to the contract for **Davis Pressure Plane Phase 2**, City of Arlington project No. **WUWS17001**.

BY: _____

Name: _____

Title: _____

Witness:

Signature

Name

Title

END OF SECTION

SECTION NO. 5

VERIFICATION RELATING TO BOYCOTTING ISRAEL

The State of Texas has passed legislation which is codified in Chapter 2270 of the Texas Government Code that prevents any municipal government from entering into a contract for goods and services unless the contractor makes certain verifications. The Contractor by signing below verifies that Contractor does not boycott Israel and will not boycott Israel during the term of the Contract. This verification when executed will be attached to the contract and become a part of the contract for all purposes. This verification relates to the contract for **Davis Pressure Plane Phase 2**, City of Arlington project No. **WUWS17001**.

BY: _____

Name: _____

Title: _____

Witness:

Signature

Name

Title

END OF SECTION

SECTION NO. 6

PROPOSAL

Proposal of: _____

Address: _____

City/State/ZIP: _____

Federal ID# _____

Date of Bid Opening: _____

TO THE CITY OF ARLINGTON, TEXAS:

The undersigned hereby proposes to furnish the equipment, fuel, labor, materials, power, tools, superintendence, transportation, and to perform the work required for the construction of **Davis Pressure Plane Phase 2**, City of Arlington Project No. **WUWS17001**, in the City of Arlington, Texas, for the following prices, which prices it is clearly and definitely understood shall include all construction materials and equipment as set out in the basis of payment in the contractual documents and maintaining same as required by the detailed specifications.

PROPOSAL SCHEDULE

MOBILIZATION & SWPPP (101 – 102)

Item No.	Quantity & Unit	Description & Price In Words	Prices in Figures	
			Unit Price	TOTAL
101	1 LS	Mobilization & Bonds in accordance with Section 11-10, for the sum of _____ One Hundred Fifty Thousand _____ dollars and _____ None _____ cents per Lump Sum.	\$150,000.00	\$150,000.00
102	1 LS	Design, Implement & Maintain Storm Water Pollution Prevention Plan, complete and in place for the sum of _____ Sixty Thousand _____ dollars and _____ None _____ cents per Lump Sum.	\$60,000.00	\$60,000.00

**SUBTOTAL MOBILIZATION & SWPPP
(Items 101 – 102)**

\$210,000.00

WATER IMPROVEMENTS (Items 201 – 257)

Item No.	Quantity & Unit	Description & Price In Words	Prices in Figures	
			Unit Price	TOTAL
201	25 LF	Furnish & Install 18-inch PVC Water Line C-900 (DR-18) 235 psi by open cut, including ductile iron fittings with polyethylene encasement, megalugs, concrete blocking, trench, embedment, & backfill, complete and in place for the sum of _____dollars and _____cents per Linear Foot.	\$	\$
202	7,250 LF	Furnish & Install 16-inch PVC Water Line C-900 (DR-18) 235 psi by open cut, including ductile iron fittings with polyethylene encasement, megalugs, concrete blocking, trench, embedment, & backfill, complete and in place for the sum of _____dollars and _____cents per Linear Foot.	\$	\$
203	120 LF	Furnish & Install 16-inch PVC Water Line C-900 (DR-18) 235 psi by open cut, including 30-inch steel casing pipe (0.5-inch minimum wall thickness), stainless steel casing spacers (minimum three per joint), pressure grout, ductile iron fittings with polyethylene encasement, megalugs, concrete blocking, trench, embedment, & backfill, complete and in place for the sum of _____dollars and _____cents per Linear Foot.	\$	\$
204	750 LF	Furnish & Install 8-inch PVC Water Line C-900 (DR-18) 235 psi by open cut, including ductile iron fittings with polyethylene encasement, megalugs, concrete blocking, trench, embedment, & backfill, complete and in place for the sum of _____dollars and _____cents per Linear Foot.	\$	\$
205	470 LF	Furnish & Install 6-inch PVC Water Line C-900 (DR-18) 235 psi by open cut, including ductile iron fittings with polyethylene encasement, megalugs, concrete blocking, trench, embedment, & backfill, complete and in place for the sum of _____dollars and _____cents per Linear Foot.	\$	\$

Item No.	Quantity & Unit	Description & Price In Words	Prices in Figures	
			Unit Price	TOTAL
206	8,615 LF	Furnish & Install Trench Safety Systems for Water Line by open cut for all depths in accordance with the Trench Safety Plan & the latest OSHA Standards, complete and in place for the sum of _____ dollars and _____ cents per Linear Foot.	\$	\$
207	250 LF	Furnish & Install 16-inch PVC Water Line C-900 (DR-18) 235 psi with Restrained Joint by bore, including pipe material, 30-inch steel casing pipe (0.5-inch minimum wall thickness), stainless steel casing spacers (minimum three per joint), bore pit, & pressure grout, complete and in place for the sum of _____ dollars and _____ cents per Linear Foot.	\$	\$
208	200 LF	Furnish & Install 6-inch or 8-inch PVC Water Line C-900 (DR-18) 235 psi by bore, including pipe material, 16-inch steel casing pipe (0.3125-inch minimum wall thickness), stainless steel casing spacers (minimum three per joint), bore pit, & pressure grout, complete and in place for the sum of _____ dollars and _____ cents per Linear Foot.	\$	\$
209	120 LF	Furnish & Install 16-inch Steel Casing Pipe (0.3125-inch minimum wall thickness) by open cut as needed, including stainless steel casing spacers (minimum three per joint), pressure grout, ductile iron fittings with polyethylene encasement, megalugs, concrete blocking, trench and trench safety, embedment, & backfill, complete and in place for the sum of _____ dollars and _____ cents per Linear Foot.	\$	\$
210	1 EA	Installed City Furnished 24-inch Resilient Wedge Gate Valve; Furnish & Install all associated appurtenances, including valve box & extension, complete and in place for the sum of _____ dollars and _____ cents per Each.	\$	\$
211	6 EA	Installed City Furnished 16-inch Resilient Wedge Gate Valve; Furnish & Install all associated appurtenances, including valve box & extension, complete and in place for the sum of _____ dollars and _____ cents per Each.	\$	\$

Item No.	Quantity & Unit	Description & Price In Words	Prices in Figures	
			Unit Price	TOTAL
212	1 EA	Furnish & Install 12-inch Resilient Wedge Gate Valve & all associated appurtenances, including valve box & extension, complete and in place for the sum of _____dollars and _____cents per Each.	\$	\$
213	15 EA	Furnish & Install 8-inch Resilient Wedge Gate Valve & all associated appurtenances, including valve box & extension, complete and in place for the sum of _____dollars and _____cents per Each.	\$	\$
214	20 EA	Furnish & Install 6-inch Resilient Wedge Gate Valve & all associated appurtenances, including valve box & extension, complete and in place for the sum of _____dollars and _____cents per Each.	\$	\$
215	4 EA	Furnish & Install 2-inch Combination Air Valve Assembly, including associated appurtenances & connection to main per detail, complete and in place for the sum of _____dollars and _____cents per Each.	\$	\$
216	5 EA	Furnish & Install 6-inch Blow-off Valve Assembly Using Fire Hydrant Detail, complete and in place for the sum of _____dollars and _____cents per Each.	\$	\$
217	7 EA	Furnish & Install Lead Free Fire Hydrant Assembly per Detail, complete and in place for the sum of _____dollars and _____cents per Each.	\$	\$
218	5 EA	Remove & Salvage Existing Fire Hydrant, work fully performed for the sum of _____dollars and _____cents per Each.	\$	\$

Item No.	Quantity & Unit	Description & Price In Words	Prices in Figures	
			Unit Price	TOTAL
219	1 EA	Cut-in City Furnished 24-inch Gate Valve into 27-inch Concrete Pipe in TESCO Easement, Furnish & Install all appurtenances and concrete pad, Connect to 27-inch Pipes, complete and in place for the sum of dollars and _____ cents per Each.	\$	\$
220	1 EA	Cut-in 18-inch x 16-inch Cross into 18-inch Concrete Pipe at Fielder Road, Furnish & Install all appurtenances, Connect to 18-inch Pipes, complete and in place for the sum of dollars and _____ cents per Each.	\$	\$
221	1 EA	Cut-in 16-inch x 16-inch Tee into 16-inch Concrete Pipe at Bowen/Venture, Furnish & Install all appurtenances, Connect to 16-inch Pipes, complete and in place for the sum of dollars and _____ cents per Each.	\$	\$
222	1 EA	Cut-in 12-inch x 12-inch Tee into 12-inch AC Pipe at Park Row/Davis, Furnish & Install all appurtenances, Connect to 16-inch and 12-inch Pipes, complete and in place for the sum of dollars and _____ cents per Each.	\$	\$
223	2 EA	Cut-in 6-inch x 6-inch Tee into 6-inch Pipe at England/Juanita, Furnish & Install all appurtenances, Connect to 6-inch Pipes, complete and in place for the sum of dollars and _____ cents per Each.	\$	\$
224	15 EA	Remove Existing Valve and Box, Cut and Plug 6-inch to 12-inch Outlet at 33-inch Water Main in Arkansas Lane, work fully performed for the sum of dollars and _____ cents per Each.	\$	\$
225	5 EA	Plug and Abandon Existing Service Outlet at 33-inch Water Main in Arkansas Lane, work fully performed for the sum of dollars and _____ cents per Each.	\$	\$

Item No.	Quantity & Unit	Description & Price In Words	Prices in Figures	
			Unit Price	TOTAL
226	15 EA	Abandon Existing Gate Valve & Box, work fully performed for the sum of _____dollars and _____cents per Each.	\$	\$
227	16 EA	Connect to Existing 6-inch to 12-inch Water Line, Gate Valve, Tee or Cross, including adaptors & offset bends, complete and in place for the sum of _____dollars and _____cents per Each.	\$	\$
228	2 EA	Connect to Existing 3-inch to 6-inch Water Service, including adaptors & offset bends, complete and in place for the sum of _____dollars and _____cents per Each.	\$	\$
229	22 EA	Relocate & Adjust Existing 1-inch or 5/8x3/4-inch AMI Water Meter to Final Grade & Location, including all fittings & piping for connection before & after Meter, detaching & reattaching AMI antenna to meter box (coordinate with Water Meter Services representative), work fully performed for the sum of _____dollars and _____cents per Each.	\$	\$
230	65 EA	Replace Existing Meter with City Furnished 1-inch or 5/8x3/4-inch AMI Meter, including all necessary items to connect water service on City side & Customer side, & adjust meter horizontally & vertically to final grade per city specifications, work fully performed for the sum of _____dollars and _____cents per Each.	\$	\$
231	46 EA	Replace Existing Meter Box with City Furnished 1-inch Meter Box, including detaching & reattaching AMI antenna to meter box (coordinate with Water Meter Services representative), & adjusting vertically & horizontally to final grade per city specifications, work fully performed for the sum of _____dollars and _____cents per Each.	\$	\$

Item No.	Quantity & Unit	Description & Price In Words	Prices in Figures	
			Unit Price	TOTAL
232	19 EA	Replace Existing Meter Box with City Furnished Bullhead Meter Box (for two 5/8x3/4-inch meters), including detaching & reattaching AMI antenna to meter box (coordinate with Water Meter Services representative), & adjusting vertically & horizontally to final grade per city specifications, work fully performed for the sum of _____dollars and _____cents per Each.	\$	\$
233	22 EA	Furnish & Install 1-inch Short Water Service from Main to Meter per Detail, complete and in place for the sum of _____dollars and _____cents per Each.	\$	\$
234	23 EA	Furnish & Install 1-inch Long Water Service from Main to Meter per Detail, complete and in place for the sum of _____dollars and _____cents per Each.	\$	\$
235	7 EA	Furnish & Install 1-inch Short Water Service from Main to Bullhead per Detail, complete and in place for the sum of _____dollars and _____cents per Each.	\$	\$
236	12 EA	Furnish & Install 1-inch Long Water Service from Main to Bullhead per Detail, complete and in place for the sum of _____dollars and _____cents per Each.	\$	\$
237	3 EA	Replace Existing Meter with City Furnished 2-inch or 1.5-inch AMI Meter, including all necessary items to connect water service on City side & Customer side, & adjust meter horizontally & vertically to final grade per city specifications, work fully performed for the sum of _____dollars and _____cents per Each.	\$	\$
238	3 EA	Replace Existing Meter Box with City Furnished 2-inch Meter Box, including detaching & reattaching AMI antenna to meter box (coordinate with Water Meter Services representative), & adjusting vertically & horizontally to final grade per city specifications, work fully performed for the sum of _____dollars and _____cents per Each.	\$	\$

Item No.	Quantity & Unit	Description & Price In Words	Prices in Figures	
			Unit Price	TOTAL
239	3 EA	Furnish & Install 2-inch Long Water Service from Main to Meter per Detail, complete and in place for the sum of dollars and _____cents per Each.	\$	\$
240	10 EA	Cut & Plug Existing 6-inch to 12-inch Water Line, work fully performed for the sum of dollars and _____cents per Each.	\$	\$
241	1 LS	Furnish, Install,& Maintain Temporary Water Service and Fire Protection for 2400 & 2420 Arkansas Lane, and 2481 Bowen Road, including all piping, valves, and connections, removal after construction (see Section 14-05 for details), work fully performed for the sum of dollars and _____cents per Lump Sum.	\$	\$
242	500 LF	Furnish & Install, Maintain, and Remove Temporary 2-inch Water Line (see Section 14-05 for details) as needed, including all the connections, complete and in place for the sum of dollars and _____cents per Linear Foot.	\$	\$
243	500 LF	Furnish & Install, Maintain, and Remove Temporary 6-inch Water Line (see Section 14-05 for details) as needed, including all the connections, complete and in place for the sum of dollars and _____cents per Linear Foot.	\$	\$
244	100 LF	Replace with 18-inch to 36-inch Class III Reinforced Concrete Storm Pipe as needed, including connection to existing pipe, trench & trench safety, embedment & backfill, and concrete collars, complete and in place for the sum of dollars and _____cents per Linear Foot.	\$	\$

Item No.	Quantity & Unit	Description & Price In Words	Prices in Figures	
			Unit Price	TOTAL
245	150 LF	Replace with 6-inch to 12-inch PVC (SDR- 26, 115 psi, Green Color) Sanitary Sewer Pipe as needed, including connection to existing pipe, trench & trench safety, embedment & backfill, complete and in place for the sum of _____dollars and _____cents per Linear Foot.	\$	\$
246	100 LF	Furnish & Install Reinforced Concrete Encasement, complete and in place for the sum of _____dollars and _____cents per Linear Foot.	\$	\$
247	30 TN	Furnish & Install Crushed Stone Cushion, complete and in place for the sum of _____dollars and _____cents per Ton.	\$	\$
248	9,500 LF	Furnish, Install & Maintain Temporary Trench Repair, immediately after water main/service line installation, including 6-inch flexbase (TxDOT Type "A"- Grade 1) & 4-inch Type "D" HMAc, complete and in place for the sum of _____dollars and _____cents per Linear Foot.	\$	\$
249	400 SY	Furnish & Install Grass Sodding to match existing yard, complete and in place for the sum of _____dollars and _____cents per Square Yard.	\$	\$
250	1,300 SY	Furnish & Install Grass Sodding to match existing median, complete and in place for the sum of _____dollars and _____cents per Square Yard.	\$	\$
251	4 EA	Tree Removal All Sizes directed by City, work fully performed for the sum of _____dollars and _____cents per Each.	\$	\$

Item No.	Quantity & Unit	Description & Price In Words	Prices in Figures	
			Unit Price	TOTAL
252	4 EA	Furnish & Plant Tree to Match Existing Species with minimum 4-inch Caliper (locations to be determined by city), complete and in place for the sum of _____ dollars and _____ cents per Each.	\$	\$
253	5 EA	Remove and Restore or Replace Street Signs, work fully performed for the sum of _____ dollars and _____ cents per Each.	\$	\$
254	50 LF	Remove and Replace with New Fence to match existing material, height, and style, complete and in place for the sum of _____ dollars and _____ cents per Linear Foot.	\$	\$
255	1 LS	Chlorinate Existing 27-inch Water Line (approximately 5,300 linear feet from Bowen Road to Fielder Road), Furnish, Install, and Plug Injection and Sample Points (minimum size ¾-inch), work fully performed for the sum of _____ dollars and _____ cents per Lump Sum.	\$	\$
256	1 LS	Chlorinate Existing 33-inch Water Line (approximately 5,300 linear feet from Bowen Road to Fielder Road), Furnish, Install, and Plug Injection and Sample Points (minimum size ¾-inch), work fully performed for the sum of _____ dollars and _____ cents per Lump Sum.	\$	\$
257	1 LS	Construction Contingency for Water and Paving Items, work fully performed for the sum of: <u>One Hundred Seventy Thousand</u> _____ dollars and _____ None _____ cents per Lump Sum.	\$170,000.00	\$170,000.00

**SUB-TOTAL WATER IMPROVEMENTS
(Items 201 – 257)**

\$ _____

SANITARY SEWER IMPROVEMENTS (Items 301 - 327)

Item No.	Quantity & Unit	Description & Price In Words	Prices in Figures	
			Unit Price	TOTAL
301	2,700 LF	Furnish & Install 8-inch Sanitary Sewer Line, PVC (SDR-26, 115 psi, Green Color) by open cut, all depths, including trench, embedment, & backfill, complete and in place for the sum of dollars and _____ cents per Linear Foot.	\$	\$
302	2,700 LF	Furnish & Install Trench Safety Systems for Sanitary Sewer Line for all depths, in accordance with the Trench Safety Plan & the latest OSHA Standards, complete and in place for the sum of dollars and _____ cents per Linear Foot.	\$	\$
303	40 LF	Furnish & Install 8-inch Sanitary Sewer Line, PVC (SDR-26, 115 psi, Green Color) by bore, including pipe material, 20-inch steel casing pipe (0.3125-inch minimum wall thickness), stainless steel casing spacers (minimum three per joint), bore pit, & pressure grout, complete and in place for the sum of dollars and _____ cents per Linear Foot.	\$	\$
304	60 LF	Furnish & Install 20-inch Steel Casing Pipe (0.3125-inch minimum wall thickness) by open cut as needed, including stainless steel casing spacers (minimum three per joint), pressure grout, trench and trench safety, embedment, & backfill,, complete and in place for the sum of dollars and _____ cents per Linear Foot.	\$	\$
305	9 EA	Furnish & Install Standard 4-foot Diameter Sewer Manhole (0-6 foot depth), complete and in place for the sum of dollars and _____ cents per Each.	\$	\$
306	1 EA	Remove & Replace Existing Manhole with a 4-foot Diameter Sewer Manhole (0-6 foot depth), work fully performed for the sum of dollars and _____ cents per Each.	\$	\$

Item No.	Quantity & Unit	Description & Price In Words	Prices in Figures	
			Unit Price	TOTAL
307	15 VF	Extra Depth for 4-foot Diameter Manhole, work fully performed for the sum of _____dollars and _____cents per Vertical Foot.	\$	\$
308	3 EA	Furnish & Install Standard 5-foot Diameter Sewer Manhole (0-6 foot depth), complete and in place for the sum of _____dollars and _____cents per Each.	\$	\$
309	1 EA	Furnish & Install Standard 5-foot Diameter Drop Sewer Manhole (0-6 foot depth), complete and in place for the sum of _____dollars and _____cents per Each.	\$	\$
310	16 VF	Extra Depth for 5-foot Diameter Manhole, work fully performed for the sum of _____dollars and _____cents per Vertical Foot.	\$	\$
311	56 EA	Furnish & Install 4-inch SDR-26 PVC Sanitary Sewer Service (Green Color) from main to property Line or easement line, including connection to existing sewer service, complete and in place for the sum of _____dollars and _____cents per Each.	\$	\$
312	4 EA	Furnish & Install 6-inch SDR-26 PVC Sanitary Sewer Service (Green Color) from main to property Line or easement line, including connection to existing sewer service, complete and in place for the sum of _____dollars and _____cents per Each.	\$	\$
313	2 EA	Abandon Existing Manhole, work fully performed for the sum of _____dollars and _____cents per Each.	\$	\$
314	2 EA	Abandon Existing Cleanout, work fully performed for the sum of _____dollars and _____cents per Each.	\$	\$

Item No.	Quantity & Unit	Description & Price In Words	Prices in Figures	
			Unit Price	TOTAL
315	9 EA	Remove & Dispose Existing Manhole, work fully performed for the sum of dollars and _____ cents per Each.	\$	\$
316	1 EA	Connect to Existing Manhole by Coring & Rework Invert, work fully performed for the sum of dollars and _____ cents per Each.	\$	\$
317	5 EA	Connect to Existing Sanitary Sewer Line, work fully performed for the sum of dollars and _____ cents per Each.	\$	\$
318	20 EA	Cut & Plug Existing Sanitary Sewer Line, work fully performed for the sum of dollars and _____ cents per Each.	\$	\$
319	1 EA	Cut & Plug Existing Sanitary Sewer Line from inside MH at Bowen/Palo Alto, work fully performed for the sum of dollars and _____ cents per Each.	\$	\$
320	100 LF	Remove & Dispose Exist. Saitary Sewer Line as directed by City, work fully performed for the sum of dollars and _____ cents per Linear Foot.	\$	\$
321	40 LF	Furnish & Install Reinforced Concrete Encasement, complete and in place for the sum of dollars and _____ cents per Linear Foot.	\$	\$
322	3,500 LF	Furnish, Install & Maintain Temporary Trench Repair, immediately after sanitary sewer main/service line installation, including 6-inch flexbase (TxDOT Type "A"-Grade 1) & 4-inch Type "D" HMAc, complete and in place for the sum of dollars and _____ cents per Linear Foot.	\$	\$

Item No.	Quantity & Unit	Description & Price In Words	Prices in Figures	
			Unit Price	TOTAL
323	200 LF	Flowable Fill 8-inch Sewer crossing Pioneer Pkwy (TxDOT), complete and in place for the sum of dollars and _____ cents per Linear Foot.	\$	\$
324	300 SY	Furnish & Install Grass Sodding to Match Existing Yard, complete and in place for the sum of dollars and _____ cents per Square Yard.	\$	\$
325	500 LF	Pre-Construction Television Inspection (as needed) to Evaluate Existing Sanitary Sewer Line Conditions & Identify Existing Services & Connections, work fully performed for the sum of dollars and _____ cents per Linear Foot.	\$	\$
326	2,700 LF	Post-Construction CCTV Inspections of Sanitary Sewer Main in accordance with Section 14-23, work fully performed for the sum of dollars and _____ cents per Linear Foot.	\$	\$
327	1 LS	Construction Contingency for Sanitary Sewer Items, work fully performed for the sum of: Sixty Thousand dollars and _____ None _____ cents per Lump Sum.	\$60,000.00	\$60,000.00

**SUB-TOTAL SANITARY SEWER IMPROVEMENTS
(Items 301 - 327)**

\$ _____

PAVING IMPROVEMENTS (ITEMS 401 – 432)

Item No.	Quantity & Unit	Description & Price In Words	Prices in Figures	
			Unit Price	TOTAL
401	6,200 SY	Remove & Dispose Existing Concrete Pavement & Curb, and Subgrade, work fully performed for the sum of dollars and _____ cents per Square Yard.	\$	\$

Item No.	Quantity & Unit	Description & Price In Words	Prices in Figures	
			Unit Price	TOTAL
402	6,200 SY	Preparation & Manipulation 10-inch Lime Treated Subgrade, work fully performed for the sum of dollars and _____ cents per Square Yard.	\$	\$
403	140 TN	Furnish Hydrated Lime for Treated Subgrade (45 lbs/SY), work fully performed for the sum of dollars and _____ cents per Ton.	\$	\$
404	6,200 SY	Preparation & Manipulation 8-inch Cement Treated Subgrade, work fully performed for the sum of dollars and _____ cents per Square Yard.	\$	\$
405	93 TN	Furnish Type I Portland Cement (30 lbs/SY), work fully performed for the sum of dollars and _____ cents per Ton.	\$	\$
406	6,200 SY	Remove & Replace with 9-inch Reinforced Concrete Pavement with Monolithic Curb (Machine finishing), including reinforcing steel, blockouts & joints, complete and in place for the sum of dollars and _____ cents per Square Yard.	\$	\$
407	1,290 SY	Remove & Replace Reinforced Concrete Pavement (hand finishing – joint to joint) with minimum 8-inch or match existing thickness, whichever is greater, 3,600 psi & monolithic curb, including 8-inch CTB under entire panel as needed, work fully performed for the sum of dollars and _____ cents per Square Yard.	\$	\$
408	1,290 SY	Additional Cost (above the cost of concrete bid item) for 8-inch High Early Strength Reinforced Concrete Paving (3600 psi/24 hours) as directed by City, complete and in place for the sum of dollars and _____ cents per Square Yard.	\$	\$

Item No.	Quantity & Unit	Description & Price In Words	Prices in Figures	
			Unit Price	TOTAL
409	6,200 SY	(Arkansas Lane) Mill Existing HMAC on top of Concrete Pavement, including two westbound lanes from Sta 44+00 to Fielder, and where the new water lines are installed in turning lanes and easebound lanes, work fully performed for the sum of _____dollars and _____cents per Square Yard.	\$	\$
410	6,200 SY	(Arkansas Lane) Overlay with HMAC on top of Concrete Pavement to match existing thickness, including two westbound lanes from Sta 44+00 to Fielder, and where the new water lines are installed in turning lanes and easebound lanes, complete and in place for the sum of _____dollars and _____cents per Square Yard.	\$	\$
411	450 SY	Remove and Replace TxDOT Continuously Reinforced Concrete Pavement (CRCP) per details, including reinforcing steel, blockouts & joints complete and in place for the sum of _____dollars and _____cents per Square Yard.	\$	\$
412	50 SY	Remove and Replace 5-inch Reinforced Concrete Residential Drive Approach on compacted native soil as directed by City, complete and in place for the sum of _____dollars and _____cents per Square Yard.	\$	\$
413	300 SY	Remove and Replace 6-inch Reinforced Concrete Commercial Drive Approach on compacted native soil as directed by City, complete and in place for the sum of _____dollars and _____cents per Square Yard.	\$	\$
414	15 SY	Remove and Replace Reinforced Concrete Median, complete and in place for the sum of _____dollars and _____cents per Square Yard.	\$	\$
415	110 SY	Remove and Replace Brick Pavers Median, complete and in place for the sum of _____dollars and _____cents per Square Yard.	\$	\$

Item No.	Quantity & Unit	Description & Price In Words	Prices in Figures	
			Unit Price	TOTAL
416	1,700 LF	Remove and Replace Reinforced Concrete Curb & Gutter, including 8-inch CTB, as directed by City, complete and in place for the sum of dollars and _____ cents per Linear Foot.	\$	\$
417	30 SY	Remove and Replace Reinforced Concrete Valley Gutter, including 8-inch CTB, complete and in place for the sum of dollars and _____ cents per Square Yard.	\$	\$
418	150 SY	Remove and Replace 4-inch thick Reinforced Concrete Sidewalks over compacted native soil, complete and in place for the sum of dollars and _____ cents per Square Yard.	\$	\$
419	14 EA	Remove and Replace ADA Compliant Barrier Free Ramp (TxDOT PED-18), complete and in place for the sum of dollars and _____ cents per Each.	\$	\$
420	3,650 SY	(Reclamation - Fielder) Pulvermix 16-inch depth for entire width of street & haul away extra material, work fully performed for the sum of dollars and _____ cents per Square yard.	\$	\$
421	4,750 SY	(Reclamation - Venture, Monte Carlo, and Cherry) Pulvermix 14-inch depth for entire width of street & haul away extra material, work fully performed for the sum of dollars and _____ cents per Square yard.	\$	\$
422	8,400 SY	Preparation & Manipulation 10-inch Lime Treated Subgrade, work fully performed for the sum of dollars and _____ cents per Square Yard.	\$	\$
423	190 TN	Furnish Hydrated Lime for Treated Subgrade (45 lbs/SY), work fully performed for the sum of dollars and _____ cents per Ton.	\$	\$

Item No.	Quantity & Unit	Description & Price In Words	Prices in Figures	
			Unit Price	TOTAL
424	8,400 SY	Preparation & Manipulation 8-inch Cement Treated Subgrade, work fully performed for the sum of dollars and _____ cents per Square Yard.	\$	\$
425	126 TN	Furnish Type I Portland Cement (30 lbs/SY), work fully performed for the sum of dollars and _____ cents per Ton.	\$	\$
426	3,650 SY	(Fielder) Furnish & Install 6-inch Type "B" HMAC Base Course for Pavement, complete and in place for the sum of dollars and _____ cents per Square Yard.	\$	\$
427	4,750 SY	(Venture, Monte Carlo, and Cherry) Furnish & Install 4-inch Type "B" HMAC Base Course for Pavement, complete and in place for the sum of dollars and _____ cents per Square Yard.	\$	\$
428	8,400 SY	Furnish & Install Paving Fabric (Petromat) between base & surface course, complete and in place for the sum of dollars and _____ cents per Square Yard.	\$	\$
429	8,400 SY	Furnish & Install 2-inch Type "D" HMAC Surface Course for Pavement, complete and in place for the sum of dollars and _____ cents per Square Yard.	\$	\$
430	1 LS	Furnish & Install Permanent Pavement Markings to match existing location and style, complete and in place for the sum of dollars and _____ cents per Lump Sum.	\$	\$
431	100 SY	Furnish & Install 4-inch Type "B" & 2-inch Type "D" HMAC, including 8-inch CTB for Permanent Asphalt Street Transition, complete and in place for the sum of dollars and _____ cents per Square Yard.	\$	\$

Item No.	Quantity & Unit	Description & Price In Words	Prices in Figures	
			Unit Price	TOTAL
432	100 SY	Furnish & Install Permanent Asphalt Pavement Backfill & Repair per detail, complete and in place for the sum of dollars and _____ cents per Square Yard.	\$	\$

**SUBTOTAL PAVING IMPROVEMENTS
(Items 401 - 432)**

\$ _____

WATER IMPROVEMENTS FOR UTA BLVD (Items 501 – 530)

Item No.	Quantity & Unit	Description & Price In Words	Prices in Figures	
			Unit Price	TOTAL
501	110 LF	Furnish & Install 12-inch PVC Water Line C-900 (DR-18) 235 psi by open cut, including ductile iron fittings with polyethylene encasement, megalugs, concrete blocking, trench, embedment, & backfill, complete and in place for the sum of dollars and _____ cents per Linear Foot.	\$	\$
502	250 LF	Furnish & Install 8-inch PVC Water Line C-900 (DR-18) 235 psi by open cut, including ductile iron fittings with polyethylene encasement, megalugs, concrete blocking, trench, embedment, & backfill, complete and in place for the sum of dollars and _____ cents per Linear Foot.	\$	\$
503	360 LF	Furnish & Install Trench Safety Systems for Water Line by open cut for all depths in accordance with the Trench Safety Plan & the latest OSHA Standards, complete and in place for the sum of dollars and _____ cents per Linear Foot.	\$	\$
504	20 TN	Furnish & Install Crushed Stone Cushion, complete and in place for the sum of dollars and _____ cents per Ton.	\$	\$

Item No.	Quantity & Unit	Description & Price In Words	Prices in Figures	
			Unit Price	TOTAL
505	2 EA	Remove & Salvage Existing Fire Hydrant, work fully performed for the sum of dollars and _____cents per Each.	\$	\$
506	13 EA	Abandon Existing Gate Valve & Box, work fully performed for the sum of dollars and _____cents per Each.	\$	\$
507	6 EA	Furnish & Install 12-inch Resilient Wedge Gate Valve & all associated appurtenances, including valve box & extension, complete and in place for the sum of dollars and _____cents per Each.	\$	\$
508	9 EA	Furnish & Install 8-inch Resilient Wedge Gate Valve & all associated appurtenances, including valve box & extension, complete and in place for the sum of dollars and _____cents per Each.	\$	\$
509	3 EA	Relocate & Adjust Existing 1-inch or 5/8x3/4-inch AMI Water Meter to Final Grade & Location, including all fittings & piping for connection before & after Meter, detaching & reattaching AMI antenna to meter box (coordinate with Water Meter Services representative), work fully performed for the sum of dollars and _____cents per Each.	\$	\$
510	3 EA	Replace Existing Meter Box with City Furnished 1-inch Meter Box, including detaching & reattaching AMI antenna to meter box (coordinate with Water Meter Services representative), & adjusting vertically & horizontally to final grade per city specifications, work fully performed for the sum of dollars and _____cents per Each.	\$	\$
511	1 EA	Install City Furnished 1-inch Meter Box, including adjusting vertically & horizontally to final grade per city specifications, work fully performed for the sum of dollars and _____cents per Each.	\$	\$

Item No.	Quantity & Unit	Description & Price In Words	Prices in Figures	
			Unit Price	TOTAL
512	2 EA	Furnish & Install 1-inch Short Water Service from Main to Meter per Detail, complete and in place for the sum of _____dollars and _____cents per Each.	\$	\$
513	2 EA	Furnish & Install 1-inch Long Water Service from Main to Meter per Detail or Plug at the end, complete and in place for the sum of _____dollars and _____cents per Each.	\$	\$
514	1 EA	Furnish & Install 2-inch Long Water Service from Main to Meter with Multi-Wye, complete and in place for the sum of _____dollars and _____cents per Each.	\$	\$
515	2 EA	Relocate & Adjust Existing 2-inch or 1.5-inch AMI Water Meter to Final Grade & Location, including all fittings & piping for connection before & after Meter, detaching & reattaching AMI antenna to meter box (coordinate with Water Meter Services representative), work fully performed for the sum of _____dollars and _____cents per Each.	\$	\$
516	2 EA	Replace Existing Meter Box with City Furnished 2-inch Meter Box, including detaching & reattaching AMI antenna to meter box (coordinate with Water Meter Services representative), & adjusting vertically & horizontally to final grade per city specifications, work fully performed for the sum of _____dollars and _____cents per Each.	\$	\$
517	2 EA	Furnish & Install 2-inch Short Water Service from Main to Meter per Detail, complete and in place for the sum of _____dollars and _____cents per Each.	\$	\$
518	17 EA	Cut-in 12-inch Fittings, Furnish & Install all appurtenances, Connect to 12-inch Pipes, complete and in place for the sum of _____dollars and _____cents per Each.	\$	\$

Item No.	Quantity & Unit	Description & Price In Words	Prices in Figures	
			Unit Price	TOTAL
519	1 EA	Connect to Existing 12-inch Water Line, Gate Valve, Tee or Cross, including adaptors & offset bends, complete and in place for the sum of _____dollars and _____cents per Each.	\$	\$
520	8 EA	Connect to Existing 6-inch to 8-inch Water Line, Gate Valve, Tee or Cross, including adaptors & offset bends, complete and in place for the sum of _____dollars and _____cents per Each.	\$	\$
521	1 EA	Cut & Plug Existing 12-inch Water Line, work fully performed for the sum of _____dollars and _____cents per Each.	\$	\$
522	3 EA	Cut & Plug Existing 12-inch Water Line on Existing 42-inch C-303, work fully performed for the sum of _____dollars and _____cents per Each.	\$	\$
523	13 EA	Cut & Plug Existing 6-inch to 8-inch Water Line, work fully performed for the sum of _____dollars and _____cents per Each.	\$	\$
524	12 EA	Cut & Plug Existing 6-inch to 8-inch Water Line on Existing 42-inch C-303, work fully performed for the sum of _____dollars and _____cents per Each.	\$	\$
525	40 SY	Remove and Replace 4-inch thick Reinforced Concrete Sidewalks over compacted native soil, complete and in place for the sum of _____dollars and _____cents per Square Yard.	\$	\$
526	15 SY	Remove and Replace Reinforced Concrete Valley Gutter, including 8-inch CTB, complete and in place for the sum of _____dollars and _____cents per Square Yard.	\$	\$

Item No.	Quantity & Unit	Description & Price In Words	Prices in Figures	
			Unit Price	TOTAL
527	350 SY	Furnish & Install Permanent Asphalt Pavement Backfill & Repair per detail, complete and in place for the sum of dollars and _____ cents per Square Yard.	\$	\$
528	110 SY	Remove and Replace TxDOT Reinforced Concrete Pavement, including reinforcing steel, blockouts & joints complete and in place for the sum of dollars and _____ cents per Square Yard.	\$	\$
529	30 LF	Furnish & Install Pavement Marking to match existing style, complete and in place for the sum of dollars and _____ cents per Linear Foot.	\$	\$
530	50 SY	Furnish & Install Grass Sodding to match existing yard, complete and in place for the sum of dollars and _____ cents per Square Yard.	\$	\$

**SUB-TOTAL WATER IMPROVEMENTS FOR UTA BLVD
(Items 501 – 530)**

\$ _____

ALTERNATE A

Item No.	Quantity & Units	Description & Price In Words	Prices in Figures	
			Unit Price	TOTAL
199A	1 LS	The additional cost for using Green Cement above the cost of cement in accordance with Section 12-38 for raw cement and for items where concrete is placed or cast-in-place, for the sum of dollars and _____ cents per Lump Sum.	\$	\$

**SUB-TOTAL ALTERNATE A
(Item 199A)**

\$ _____

TOTAL BASE BID SUMMARY

MOBILIZATION & SWPPP \$ 210,000.00
(Items 101 – 102)

WATER IMPROVEMENTS \$ _____
(Items 201 – 257)

SANITARY SEWER IMPROVEMENTS \$ _____
(Items 301 - 327)

PAVING IMPROVEMENTS \$ _____
(Items 401 - 432)

WATER IMPROVEMENTS FOR UTA BLVD \$ _____
(Items 501 – 530)

TOTAL BASE BID \$ _____

TOTAL BASE BID + ALTERNATE A \$ _____

In case of ambiguity or lack of clearness in stating prices in the Proposal, the City reserves the right to accept the most advantageous construction thereof to the City or to reject the Proposal.

The undersigned bidder agrees to begin work within ten (10) days from the beginning date of the project as provided in the written Notice to Proceed and to complete the work within 330 calendar days; provided, that the OWNER'S construction funds are available.

Enclosed with this Proposal is a Bidder's Bond or Cashier's Check for five percent bidders bond (\$5%) dollars, which it is agreed shall be collected and retained by the OWNER as liquidated damages if the OWNER accepts this bid within ninety (90) days after the opening of bids, and the undersigned bidder then fails to execute the contract and bonds with the said OWNER within ten (10) days after official notice of such acceptance; otherwise, said Bidder's Bond or Check shall be returned to the undersigned on demand. This sum of money is not to be considered as a penalty, but shall be deemed, taken and treated as reasonable liquidated damages. The sum of money is fixed and agreed on between the bidder and OWNER because of the impracticability and extreme difficulty of fixing and ascertaining the actual damage to the owner.

The undersigned acknowledges receipt of the following addendum:

Addendum No. 1 _____

Addendum No. 2 _____

Addendum No. 3 _____

BIDDER

Company

By _____

(Please Print)

Title

Address

(Seal if corporation)

City State Zip

SECTION NO. 7

STATE OF TEXAS §

Contract

COUNTY OF TARRANT §

PROJECT NO. _____

This Contract, made and entered into this _____ day of _____, 20____, by and between the City of Arlington of Tarrant County, Texas, a municipal corporation, hereinafter called "Owner," and _____, hereinafter called "Contractor."

W I T N E S S E T H:

For and in consideration of the payment, agreements and conditions hereinafter mentioned, and under the conditions expressed in the bonds herein, Contractor hereby agrees to complete the construction of improvements described as follows:

**Davis Pressure Plane Phase 2
City of Arlington Project No. WUWS17001**

in the City of Arlington, Texas, and all extra work in connection therewith, under the terms as stated in the latest versions of the:

Standard Specifications for Public Works Construction Standards, as issued by the North Central Texas Council of Governments, and;

City of Arlington Standard Specifications For Water & Sanitary Sewer Construction,

as they may be amended from time to time (hereinafter collectively called "Standard Specifications"), and under the terms of all Special Provisions and Special Specifications of this Contract; and at his, her or their own proper cost and expense to furnish all superintendence, labor, insurance, equipment, tools and other accessories and services necessary to complete the said construction in accordance with all the Contract documents, incorporated herein as if written word for word, and in accordance with the plans, which include all maps, plats, blueprints, and other drawings and printed or written explanatory manner therefore, and the specifications as prepared by **City of Arlington** hereinafter called Engineer, who has been identified by the endorsement of the Contractor's written proposal, these General Provisions of the Standard Specifications, the Special Provisions, and the Special Specifications of this Contract, the payment, performance, and maintenance bonds hereto attached; all of which are made a part hereof and collectively evidence and constitute the entire Contract.

The Contractor hereby agrees to commence work within ten (10) days from the beginning date of the project as provided in the written Notice to Proceed and to complete the work within 330 calendar days from the beginning date of the project.

The Owner agrees to pay the Contractor in current funds for the performance of the Contract in accordance with the proposal submitted therefore, subject to additions and deductions, as provided therein.

This Contract is entered into subject to the Charter and ordinances of Owner, as they may be amended from time to time, and is subject to and is to be construed, governed, and enforced under all applicable State of Texas and federal laws. Situs of this Contract is agreed to be Tarrant County, Texas, for all purposes including performance and execution.

If any of the terms, sections, subsections, sentences, clauses, phrases, provisions, covenants, or conditions of this Contract is held for any reason to be invalid, void or unenforceable, the remainder of the terms, sections, subsections, sentences, clauses, phrases, provisions, covenants, or conditions of this Contract shall remain in full force and effect and shall in no way be affected, impaired, or invalidated.

Owner reserves the right to terminate this agreement immediately upon breach of any term or provision of this Contract by Contractor; or, if any time during the term of this Contract, Contractor shall fail to commence the work in accordance with the provisions of this Contract or fail to diligently provide Services in an efficient, timely, and careful manner and in strict accordance with the provisions of this Contract or fail to use an adequate number or quality of personnel and equipment to complete the work or fail to perform any of its obligations under this Contract, then Owner shall have the right, if Contractor shall not cure any such default after thirty (30) days written notice thereof, to terminate this Contract and complete the work in any manner it deems desirable, including engaging the Services of other parties therefore. Any such act by Owner shall not be deemed a waiver of any other right or remedy of Owner. If after exercising any such remedy the cost to Owner of the performance of the balance of the work is in excess of that part of the Contract sum which has not theretofore been paid to Contractor hereunder, Contractor shall be liable for and shall reimburse Owner for such excess.

No right or remedy granted herein or reserved to the parties is exclusive of any other right or remedy herein by law or equity provided or permitted; but, each shall be cumulative of every other right or remedy given hereunder. No covenant or condition of this Contract may be waived without consent of the parties. Forbearance or indulgence by either party shall not constitute a waiver of any covenant or condition to be performed pursuant to this Contract.

Contractor's status shall be that of an independent Contractor and not an agent, servant, employee or representative of Owner in the performance of this Contract. No term or provision of, or act of Contractor or Owner under this Contract shall be construed as changing that status.

This Contract embodies the complete agreement of the parties hereto, superseding all oral or written previous and contemporary agreements between the parties relating to matters herein; and except as otherwise provided herein, cannot be modified without the written agreement of the parties.

Owner and Contractor each bind themselves, their successors, executors, administrators and assigns to the other party to this Contract. Neither Owner nor Contractor will assign, sublet, subContract or transfer any interest in this Contract without the written consent of the other party. No assignment, delegation of duties or subcontract under this Contract will be effective without the written consent of Owner.

It is further agreed that one or more instances of forbearance by the City in the exercise of its rights herein shall in no way constitute a waiver thereof.

In performing this Contract, Contractor agrees to use diligent efforts to purchase all goods and services from Arlington Businesses whenever such goods and services are comparable in availability, quality and price.

{Signature Pages Follows}

IN WITNESS WHEREOF, the parties of these presents have executed this agreement in the year and date first written above.

CONTRACTOR

Company Name

Tax Identification Number:

By _____
Signature

Printed or Typed Name

Printed or Typed Title

CITY OF ARLINGTON, TEXAS

ATTEST:

Craig M. Commings
Director of Water Utilities

Alex Busken

APPROVED AS TO FORM:
TERIS SOLIS, City Attorney

BY _____

THE STATE OF TEXAS §

Contractor Acknowledgment

COUNTY OF _____ §

BEFORE ME, the undersigned authority, a Notary Public in and for the State of Texas, on this day personally appeared _____, who is known to me or who was proved to me on the oath of _____ (name of person identifying the acknowledging person) or who was proved to me through _____ (description of identity card or other document issued by the federal or state government containing the picture and signature of the acknowledging person) to be the person whose name is subscribed to the foregoing instrument, and acknowledged to me that he/she executed same for and as the act and deed of _____, a corporation of _____ County, Texas, and as _____ thereof, and for the purposes and consideration therein expressed and in the capacity therein stated.

GIVEN UNDER MY HAND AND SEAL OF OFFICE this the _____ day of _____, 20_____.

Notary Public In and For The State of Texas

Notary's Printed Name

THE STATE OF TEXAS §

City Acknowledgement

COUNTY OF TARRANT §

BEFORE ME, the undersigned authority, a Notary Public in and for the State of Texas, on this day personally appeared Craig M. Cummings, known to me to be a person and officer whose name is subscribed to the foregoing instrument, and acknowledged to me that he/she executed same for and as the act of the City of Arlington, Texas, a Texas municipal corporation, and as Director of Water Utilities thereof, and for the purposes and consideration therein expressed.

GIVEN UNDER MY HAND AND SEAL OF OFFICE this the _____ day of _____, 20_____.

Notary Public In and For The State of Texas

Notary's Printed Name

END OF SECTION

SECTION NO. 8

THE STATE OF TEXAS §

Performance Bond

COUNTY OF TARRANT §

KNOW ALL BY THESE PRESENTS:

THAT _____

of the City of _____, County of _____

State of _____ hereinafter referred to as "PRINCIPAL," and

_____, a corporate surety/sureties organized under the laws of the State of _____ and authorized to do business in the State of Texas, hereinafter referred to as "SURETY," (whether one or more), are held and firmly bound unto the CITY OF ARLINGTON, TEXAS, a municipal corporation located in Tarrant County, Texas, hereinafter referred to as "CITY," in the amount of _____ DOLLARS (\$ _____), lawful money of the United States, to be paid in Arlington, Tarrant County, Texas, for the payment of which sum well and truly to be made, we bind ourselves, our heirs, executors, assigns, administrators and successors, jointly and severally; and firmly by these presents, the condition of this obligation is such that,

WHEREAS, PRINCIPAL entered into a certain written Contract with the City of Arlington dated the _____ day of _____, 20____, a copy of which is attached hereto and made a part hereof, to furnish all materials, equipment, labor, supervision, and other accessories necessary for the construction of:

**Davis Pressure Plane Phase 2
City of Arlington Project No. WUWS17001**

in the City of Arlington, Texas, as more particularly described and designated in the above referenced contract such contract being incorporated herein and made a part hereof as fully and to the same extent as if written herein word for word:

NOW THEREFORE,

If PRINCIPAL shall well, truly and faithfully perform and fulfill all of the undertakings, covenants, terms, conditions and agreements of the above referenced Contract in accordance with the plans, specifications and Contract documents during the original term thereof, and any extension thereof which may be granted with or without notice to SURETY, and during the life of any guaranty required under the Contract, and shall also well and truly perform and fulfill all the covenants, terms, conditions and agreements of

any and all authorized modifications of such Contract that may hereafter be made, notice of which modifications to SURETY being hereby waived, then this obligation shall be void, otherwise to remain in full force and effect; and in case PRINCIPAL shall fail to do so, it is agreed that CITY may do such work and supply such materials and charge the same against PRINCIPAL and SURETY on this obligation, and PRINCIPAL and SURETY hereon shall be subject to the liquidated damages mentioned in the Contract for each day's failure on its part to comply with the terms and provisions of such Contract.

Provided, further, that if any legal action be filed on this Bond, venue shall lie in Tarrant County, Texas.

And, that SURETY, for value received, hereby stipulates and agrees that no change, extension of time, alteration or addition to the terms of the Contract or to the work performed thereunder, or the plans, specifications, drawings, etc., accompanying same shall in any way affect its obligation on this Bond; and it does hereby waive notice of any such change, extension of time, alteration or addition to the terms of the Contract or to the work to be performed thereunder.

The undersigned and designated agent is hereby designated by SURETY as the agent resident in either Tarrant or Dallas County to whom any requisite notice may be delivered and on whom service of process may be had in matters arising out of such suretyship.

IN WITNESS WHEREOF, this instrument is executed on this the _____ day of _____, 20__.

WITNESS

PRINCIPAL

Company

By _____
Signature

By _____
Signature

Typed/Printed Name

Typed/Printed Name

Title

Title

Address

Address

City State Zip

City State Zip

WITNESS

By _____
Signature

Typed/Printed Name

Title

Address

City State Zip

SURETY

Company

By _____
Signature

Typed/Printed Name

Title

Address

City State Zip

NOTE: Date of Performance Bond must NOT be prior to date of Contract

END OF SECTION

SECTION NO. 9

THE STATE OF TEXAS §

Payment Bond

COUNTY OF TARRANT §

KNOW ALL BY THESE

PRESENTS:

THAT _____

of the City of _____, County of _____

State of _____ hereinafter referred to as "PRINCIPAL", and

_____, a corporate surety/sureties organized under the laws of the State of _____ and authorized to do business in the State of Texas, hereinafter referred to as "SURETY", (whether one or more), are held and firmly bound unto the CITY OF ARLINGTON, TEXAS, a municipal corporation located in Tarrant County, Texas, hereinafter referred to as "CITY", and unto all persons, firms and corporations who may furnish materials for or perform labor upon the buildings, structures or improvements referred to in the attached Contract, in the penal sum of _____ DOLLARS and _____ CENTS(\$ _____), lawful money of the United States, to be paid in Arlington, Tarrant County, Texas, for the payment of which sum well and truly to be made, we bind ourselves, our heirs, executors, administrators, successors, and assigns, jointly and severally; and firmly by these presents, the condition of this obligation is such that,

WHEREAS, PRINCIPAL entered into a certain Contract with the City of Arlington, dated the day of _____, _____, a copy of which is attached hereto and made a part hereof, to furnish all materials, equipment, labor, supervision, and other accessories necessary for the construction of:

**Davis Pressure Plane Phase 2
City of Arlington Project No. WUWS17001**

in the City of Arlington, Texas, as more particularly described and designated in the above referenced contract such contract being incorporated herein and made a part hereof as fully and to the same extent as if written herein word for word:

NOW THEREFORE,

If PRINCIPAL shall well, truly and faithfully perform its duties and make prompt payment to all persons, firms, subcontractors, corporations and claimants supplying labor and materials in the prosecution of the work provided for in the above referenced Contract and any and all duly authorized modifications of such Contract that may hereafter be

made, notice to SURETY of such modifications being hereby waived, then this obligation shall be void, otherwise to remain in full force and effect.

PROVIDED, further, that if any legal action be filed on this Bond, venue shall lie in Tarrant County, Texas.

And, that such SURETY, for value received, hereby stipulates and agrees that no change, extension of time, alteration or addition to the terms of the Contract or to the work performed thereunder, or the plans, specifications, drawings, etc. accompanying same shall in any way affect its obligation on this Bond; and it does hereby waive notice of any such change, extension of time, alteration or addition to the terms of the Contract or to the work to be performed thereunder.

This Bond is given pursuant to the provisions of Chapter 2253 of the Government Code, as amended. The terms "payment bond beneficiary", "public work labor", and "public work material", as used herein, are in accordance with and as defined in the relevant provisions of Chapter 2253 of the Government Code.

The undersigned and designated agent is hereby designated by SURETY herein as the resident agent in either Tarrant or Dallas Counties to whom any requisite notice may be delivered and on whom service of process may be had in matters arising out of such suretyship.

IN WITNESS WHEREOF, this instrument is executed on this the _____ day of _____, 20__.

WITNESS

PRINCIPAL

By _____
Signature

By _____
Signature

Typed/Printed Name

Typed/Printed Name

Title

Title

Address

Address

City State Zip

City State Zip

WITNESS

SURETY

By _____
Signature

Typed/Printed Name

Title

Address

City State Zip

Company

By _____
Signature

Typed/Printed Name

Title

Address

City State Zip

The Resident Agent of the SURETY in either Tarrant or Dallas County, Texas, for delivery of notice and service of process is:

NAME _____

ADDRESS _____

NOTE: Date of Payment Bond must NOT be prior to date of Contract.

END OF SECTION

SECTION NO. 10

THE STATE OF TEXAS §

Maintenance Bond

COUNTY OF TARRANT §

KNOW ALL BY THESE PRESENTS:

THAT _____

of the City of _____, County of _____

State of _____ hereinafter referred to as "PRINCIPAL," and

_____, a corporate surety/sureties organized under the laws of the State of _____ and authorized to do business in the State of Texas, hereinafter referred to as "SURETY," (whether one or more), are held and firmly bound unto the CITY OF ARLINGTON, TEXAS, a municipal corporation located in Tarrant County, Texas, hereinafter referred to as "CITY," in the amount of _____ DOLLARS (\$ _____), lawful money of the United States, to be paid in Arlington, Tarrant County, Texas, for the payment of which sum well and truly to be made, we bind ourselves, our heirs, executors, assigns, administrators and successors, jointly and severally; and firmly by these presents, the condition of this obligation is such that:

WHEREAS, PRINCIPAL entered into a certain written Contract with City of Arlington, dated the _____ day of _____, 20____, a copy of which is attached hereto and made a part hereof, to furnish all materials, equipment, labor, supervision, and other accessories necessary for the construction of:

**Davis Pressure Plane Phase 2
City of Arlington Project No. WUWS17001**

in the City of Arlington, Texas, as more particularly described and designated in the above referenced contract such contract being incorporated herein and made a part hereof as fully and to the same extent as if written herein word for word:

NOW THEREFORE,

If PRINCIPAL will maintain and keep in good repair the work herein contracted to be done and performed for a period of two (2) years from the date of acceptance and perform all necessary work and repair any defective condition growing out of or arising in any part of the construction of said improvement, including but not limited to; performing all necessary backfilling that may arise on account of sunken conditions in ditches, or otherwise, repair any defective condition growing out of or arising from the improper joining of underground infrastructures, or on account

of any breaking of infrastructures caused by PRINCIPAL in laying or building the infrastructures, or on account of any defect arising in any of such work laid or constructed by PRINCIPAL, or on account of improper excavation or backfilling. It being understood that the purpose of this section is to cover all defective conditions arising by reason of defective materials, work or labor performed by PRINCIPAL; then this obligation shall be void, otherwise it shall remain in full force and effect; and in case PRINCIPAL shall fail to do so, it is agreed that CITY may do such work and supply such materials and charge the same against PRINCIPAL and SURETY on this obligation, and in addition, PRINCIPAL and SURETY herein shall be subject to the liquidated damages as provided in the Contract referred to herein for each day's failure on its part to comply with the terms and provisions of such Contract.

Provided, further, that if any legal action be filed on this Bond, venue shall lie in Tarrant County, Texas.

And, that SURETY, for value received, hereby stipulates and agrees that no change, extension of time, alteration or addition to the terms of the Contract or to the work performed thereunder, or the plans, specifications, drawings, etc., accompanying same shall in any way affect its obligation on this Bond; and it does hereby waive notice of any such change, extension of time, alteration or addition to the terms of the Contract or to the work to be performed thereunder.

The undersigned and designated agent is hereby designated by SURETY as the resident agent in either Tarrant or Dallas County to whom any requisite notice may be delivered and on whom service of process may be had in matters arising out of such suretyship.

IN WITNESS WHEREOF, this instrument is executed on this the _____ day of _____, 20____.

WITNESS

PRINCIPAL

By _____
Signature

Typed/Printed Name

Title

Address

City State Zip

Company

By _____
Signature

Typed/Printed Name

Title

Address

City State Zip

WITNESS

SURETY

By _____
Signature

By _____
Signature

Typed/Printed Name

Typed/Printed Name

Title

Title

Address

Address

City State Zip

City State Zip

NOTE: Date of Maintenance Bonds must NOT be prior to date of Contract

END OF SECTION

SECTION NO. 11

SPECIAL PROVISIONS – GENERAL ADMINISTRATION SPECIFICATIONS

NUMERICAL LISTING

Section No.	
11-01	PURPOSE OF SPECIAL PROVISIONS
11-02	SCOPE OF WORK
11-03	MINORITY / WOMEN BUSINESS ENTERPRISE (MWBE) CONTRACT SPECIFIC GOAL
11-04	MINORITY / WOMEN BUSINESS ENTERPRISE (MWBE) POST AWARD COMPLIANCE
11-05	PREVAILING WAGE RATES
11-06	BONDS, INSURANCE, & AFFIDAVITS
11-07	INDEMNIFICATION
11-08	RIGHT TO AUDIT
11-09	SALES TAX EXEMPTION
11-10	CONTRACTOR PERSONNEL
11-11	MOBILIZATION AND BONDS
11-12	SUBMITTALS
11-13	CONSTRUCTION MEETING
11-14	PUBLIC MEETING
11-15	TIME FOR COMPLETION & LIQUIDATED DAMAGES
11-16	BONUS
11-17	COMPUTATION OF CONTRACT TIME FOR COMPLETION & DELAYS
11-18	CONSTRUCTION CONTINGENCY ALLOWANCE
11-19	MATERIALS AND WORKMANSHIP: WARRANTIES AND GUARANTEES
11-20	DEFECTIVE MATERIALS, EQUIPMENT, OR IN-PLACE CONSTRUCTION
11-21	QUALITY ASSURANCE/QUALITY CONTROL (QA/QC)
11-22	SAFETY DATA SHEET
11-23	SATURDAY OR CITY HOLIDAY INSPECTIONS
11-24	WORK PERFORMED WITHOUT BENEFIT OF INSPECTIONS
11-25	MONTHLY ESTIMATE
11-26	OWNER NOTIFICATION
11-27	SIGNS FOR BUSINESSES
11-28	PROJECT SIGNS
11-29	QUANTITIES
11-30	CONTRACTOR SELF-PERFORMANCE

SECTION NO. 11

SPECIAL PROVISIONS – GENERAL ADMINISTRATION SPECIFICATIONS

11-01 PURPOSE OF SPECIAL PROVISIONS:

- A. Paving and Drainage improvements shall be in accordance with the latest version of the STANDARD SPECIFICATIONS FOR PUBLIC WORKS CONSTRUCTION STANDARDS as issued by The North Central Texas Council of Governments (NCTCOG); Water and Sanitary Sewer improvements shall be in accordance with the latest version of the CITY OF ARLINGTON STANDARD SPECIFICATIONS FOR WATER & SANITARY SEWER CONSTRUCTION; hereinafter collectively referred to as “Standard Specifications”.
- B. All Special Provisions included in this contract document are for the purpose of adapting the Standard Specifications to the particular project which is subject to this agreement and of adding thereto such further provisions as may be necessary to state the contract in its entirety.
- C. The work shall conform to the requirements of the Special Provisions and the details as shown on the drawings. These contract documents are intended to be complementary. The intent of the contract documents, including the Standard Specifications, Special Provisions, and other instruments, documents, drawings and maps comprising the Plans and Specifications, is to describe the completed work to be performed by the Contractor under the contract as an independent Contractor. Requirements of any of the contract documents are as binding as if called for by all. Any provision of the agreement vesting in the City or the engineer the right of inspection is understood by all the parties to be for the purpose of ensuring that the plans and specifications are complied with and that the completed work is obtained and described, and no such provision shall be interpreted as vesting the City or engineer the right to control the details of work.
- D. In the event of conflict between documents, Special Provisions shall take priority over drawings, and drawings shall govern over Standard Specifications.
- E. References made to TxDOT Items in this contract shall mean items in the latest version of the Standard Specifications for Construction and Maintenance of Highways, Streets, and Bridges as published by the Texas Department of Transportation. Further technical requirements contained in other publications are referenced in sections where they apply and are hereby incorporated.
- F. References made to “City” shall mean the City of Arlington.

11-02 SCOPE OF WORK:

- A. The work governed by these specifications is located in the City of Arlington, Texas and consists of **Davis Pressure Plane Phase 2**, City of Arlington Project No. **WUWS17001**, including all necessary appurtenances.
- B. The Contractor shall provide, at his/her own expense, all construction staking required to perform the work as described in the plans and specifications. For City capital projects,

control monuments may be verified by the City. The Contractor shall set excavation and fill stakes on or near the right-of-way, all stakes necessary for water or sewer relocation and storm drain placement, 4-foot off-set back of curb stakes for subgrade stabilization and paving, and intermediate grade stakes (i.e. blue topping, fill, or cut stakes) on the centerline. All staking shall be subjected to inspection by the City. While the City shall have the right to inspect, it shall have no duty to inspect. The Contractor will be responsible for any discrepancies from the plan alignment and/or grade. Calendar days will not be adjusted due to the lack of available crews or due to the negligence of the Contractor or vandalism that causes the replacement of stakes.

- C. Work shall be accomplished between the hours of 7 a.m. to 6 p.m. (Central Standard Time) and 7 a.m. to 8 p.m. (Central Daylight Savings Time), Monday through Friday unless otherwise approved by the City. For Saturday and holiday inspections, see Section 11-22.
- D. Contractor is responsible to stay informed of all events involving the AT&T (Cowboys) Stadium, Globe Life Field (Texas Rangers) and any other major events at other venues in the Entertainment District. Contractor shall not work in the Entertainment District unless approved by the City's Traffic Engineering division. Upon approval to proceed with construction, the Contractor must complete work and remove all traffic control devices two (2) days prior to the next event, or as directed by the City. It will be the responsibility of the Prime Contractor to see that Subcontractor(s) is in compliance with requirement.

11-03 MINORITY/WOMEN BUSINESS ENTERPRISE (MWBE) CONTRACT

SPECIFIC GOAL: The City's Minority/Woman Business Enterprise (MWBE) utilization goal, for this project is **24** %.

The contractor's MWBE commitment percentage is based on the total value of the contract including any change orders and modifications throughout the contract agreement.

11-04 MINORITY/WOMEN BUSINESS ENTERPRISE (MWBE) POST AWARD COMPLIANCE:

- A. The Contractor shall report all subcontractor payment activity with the Contractor's monthly estimate in accordance to **Section 11-25**. If change orders, amendments or any contract modification are issued by the City, the Contractor has a contractual commitment to meet and/or exceed their MWBE utilization goal. Contractor is obligated to immediately notify the City, in writing, of any agreed increase or decrease in the scope of work that will impact the MWBE participation in the contract.
- B. The Contractor cannot terminate, substitute, or change the terms of the MWBE Utilization Plan prior to or after Contract award without prior written consent from the City. If the Contractor is unable to meet its MWBE commitment with certified MWBE companies, the Contractor shall satisfy its commitment, as it relates to the scope of work changes, modifications, and/or amendments by soliciting new certified MWBE companies. Contractor shall submit a Request for Approval of Change to MWBE Utilization Plan for review and written approval from the City.

If the City observes any MWBE subcontractor other than those listed on the MWBE Utilization Plan are performing work or providing materials and/or equipment for those MWBE Subcontractors listed on the MWBE Utilization Plan, the Contractor will be notified in writing that an apparent violation is taking place and payments may be withheld in addition to any other sanctions included in the MWBE Policy and Procedures Manual. The Contractor will be given an opportunity to meet with the City prior to a finding of noncompliance.

- C. Contractor shall pay its subcontractors no later than the 5th business day after the date the prime contractor receives payment from the City. The prime contractor also agrees to promptly request the release of any retainage withheld from subcontractors within five (5) business days after the subcontractor's work is satisfactorily completed and receives partial acceptance, substantial completion or final completion/final acceptance as defined in the General Provisions of the contract. Furthermore, the prime contractor agrees to pay the subcontractor its retainage within five (5) business days after the date the prime contractor receives the subcontractor's retainage payment from the City.

A finding of non-payment shall be a material breach of this contract. The City may withhold progress payments until the Contractor demonstrates timely payment due all subcontractors. The City also reserves the right to exercise other breach of contract remedies.

- D. During the performance of this Contract, the Contractor or Subcontractor agrees that it will not discriminate on the basis of on race, age, color, religion, sex, sexual orientation, gender identity, national origin, ancestry, gender, disability, or place of birth in the award. Failure by the Contractor to ensure non-discrimination is a material breach of this Contract, which may result in the termination of this Contract or such other remedy, as the City deems appropriate. The Contractor must insert the substance of this clause in all Subcontracts and purchase orders.

- E. The failure by the Contractor to carry out the requirements of the Program is a material breach of the Contract and may result in the termination of the Contract or such other remedies as the City deems appropriate. Violation of MWBE Policies and Procedures, or Contractual obligations, may result in any one or more of the following sanctions:

1. Administrative Warning: Issued for first-time violations or minor violations.
2. Withholding of funds payable under the Contract, including, but not limited to, funds payable for work self-performed by the Contractor or applicable retainage.
3. Temporarily suspending, at no cost to the City, Contractor's performance under the Contract.
4. Termination of the Contract.
5. Suspension/debarment of a Contractor for a period of time from participating in any solicitations issued by the City.

11-05 PREVAILING WAGE RATES:

- A. The Contractor shall comply with V.T.C.A., Government Code, Chapter 2258, in performing this project. In accordance with V.T.C.A., Government Code, Chapter 2258, the prevailing wage rates as set forth in Section 2 of the contract documents shall be paid

on this project. For overtime work and legal holidays, the hourly rate shall be one and one-half (1½) times the basic hourly rate set forth in Section 2. The City will require Contractor to execute an affidavit affirming that all wages are in strict compliance with the established prevailing wages rates as described in the contract documents and all wages have been or will be paid accordingly. The City reserves the right to conduct interviews with the Contractor's employees to ensure compliance with Section 2 of the contract documents in accordance with applicable State and Federal Laws.

- B. Upon written request by the City, the general Contractor shall be responsible for submitting payroll information to the City for all employees performing work on the project, whether employed by the general Contractor or a subcontractor to the general Contractor. Each submittal shall be certified by the general Contractor as to completeness and accuracy.
- C. A Contractor or subcontractor in violation of V.T.C.A., Government Code, Chapter 2258 is liable for a penalty. That Contractor or subcontractor shall pay to the City sixty dollars (\$60.00) for each laborer, workman, or mechanic employed for each calendar day, or portion thereof, such laborer, workman, or mechanic is paid less than the said stipulated rates for work done under the contract.
- D. The Contractor or subcontractor violating a requirement of this Special Provision may be determined ineligible to bid on or receive any additional work during the calendar year following the year in which the violation of this Special Provision occurred.

11-06 BONDS, INSURANCE AND AFFIDAVITS:

- A. The following bonds and proof of insurance shall be filed with the City of Arlington as a condition of the contract, together with appropriate powers of attorney.
 - 1. Performance, Payment, And Maintenance Bonds: Performance, payment and maintenance bonds in the amount of not less than one hundred percent (100%) of the contract price conditioned upon the faithful performance of the contract, and upon payment of all persons supplying labor or furnishing materials, will be required upon the forms which are a part of the Contract Documents. Bonds shall be executed by a surety company authorized to do business in the State of Texas and acceptable to and approved by the City. The period of the Maintenance Bond shall be two (2) years from the date of acceptance of all work done under the contract, to cover the guarantee as set forth in the Special Provisions.
 - 2. Performance Bonds And Payment Bonds In Excess Of \$100,000: In addition to all other requirements set forth with regard to performance bonds and payment bonds, any performance bond or payment bond in an amount exceeding One Hundred Thousand Dollars (\$100,000) must be issued by a surety that is qualified as a surety on obligations permitted or required under federal law as indicated by publication of the surety's name in the current U.S. Treasury Department Circular 570. In the alternative, an otherwise acceptable surety company that is authorized and admitted to write surety bonds in Texas must obtain reinsurance on any amounts in excess of One Hundred Thousand Dollars (\$100,000) from a reinsurer authorized and admitted as a reinsurer in Texas who qualifies as a surety or reinsurer on obligations permitted

or required under federal law as indicated by publication of the surety's or reinsurer's name in the current U.S. Treasury Department Circular 570.

3. Insurance: Contractor shall, at his/her own expense, purchase, maintain and keep in force during the term of this contract such insurance as set forth below. Contractor shall not commence work under this contract until he/she has obtained all the insurance required under the contract and such insurance has been approved by the City, nor shall the Contractor allow any subcontractor to commence work on his/her subcontract until all similar insurance of the subcontractor has been obtained and approved. All insurance policies provided under this contract shall be written on an "occurrence" basis. The policy limits stated below are at a minimum.

Liability Insurance

Commercial General Liability (No standard coverages are to be excluded by endorsement. XCU and contractual liability are not to be excluded)	\$1,000,000 Per Occurrence/ \$2,000,000 Aggregate
---	--

Automobile Liability Insurance

Commercial Auto Liability Policy (Any Auto, including hired, and non-owned autos)	\$ 1,000,000 Combined Single Limit
---	------------------------------------

Umbrella Liability

(Following Form and Drop Down Provisions Included)	\$2,000,000 Each Occurrence
---	-----------------------------

Workers' Compensation Insurance

Workers' Compensation	Statutory Limit
Employer's Liability	\$1,000,000 Each Occurrence \$1,000,000 Disease - Each Employee \$1,000,000 Disease – Policy Limit

Professional Liability – required for Contractor or subcontractor performing CCTV services and report

Or Errors & Omissions coverage	\$1,000,000 per claim \$2,000,000 Aggregate	(Rev. 1/2020)
--------------------------------	--	---------------

- B. It is agreed by all parties to this contract that the insurance policies required under this contract shall be endorsed to provide:
 1. The City, its officials, employees and volunteers shall be named as an additional insured on the Commercial General Liability, Automobile Liability and Umbrella Liability insurance policies. These insurance policies shall contain the appropriate additional insured endorsement to cover premises/operations and products/completed operations, including materials, equipment or supplies provided by the City. (Rev. 9/2019)

2. The General Liability policy shall be endorsed as primary and non-contributory with other insurance carried by the City, and aggregate policy limits shall apply “per project”;
3. Provide for thirty (30) days notice of cancellation to the City, ten (10) days notice of cancellation is acceptable for nonpayment of premium;
4. Be written through companies duly authorized to transact that class of insurance in the State of Texas with an A.M. Best rating of A:VII or better; and,
5. Waive subrogation rights for loss or damage so that insurers have no right to recovery or subrogation against the City of Arlington, it being the intention that the required insurance policies shall protect all parties to the contract and be primary coverage for all losses covered by the policies.
6. Provide one copy of a Certificate of Insurance on an Acord form or other State-approved form evidencing the required coverages to:

Arlington Water Utilities Department, MS01-0200
Attention: Ashley Brown, Capital Projects Coordinator
City of Arlington
P.O. Box 90231
Arlington, TX 76004-3231

- C. Neither final payment nor any remaining retained percentage shall become due until the Contractor submits to the City (1) an affidavit that payrolls, bills for materials and equipment, and other indebtedness connected with the work for which the City or the City’s property might be responsible or encumbered (less amounts withheld by City) have been paid or otherwise satisfied, (2) a certificate evidencing that insurance required by the contract documents to remain in force after final payment is currently in effect and will not be canceled or allowed to expire until at least thirty (30) days prior written notice has been given to the City, (3) a written statement that the Contractor knows of no substantial reason that the insurance will not be renewable to cover the period required by the contract documents, (4) consent of Surety, if any, to final payment and (5) if required by the City, other data establishing payment or satisfaction of obligations, such as receipts, releases and waivers of liens, claims, security interests or encumbrances arising out of the contract, to the extent and in such form as may be designated by the City. If a subcontractor refuses to furnish a release or waiver required by the City, the Contractor may furnish a bond satisfactory to the City to indemnify the City of Arlington against such lien. If such lien remains unsatisfied after payments are made, the Contractor shall refund to the City all money that the City may be compelled to pay in discharging such lien, including all costs and reasonable attorneys’ fees.
- D. In addition to the requirements contained above, the Contractor shall comply with the following in its provision of workers’ compensation insurance.
1. Definitions:
Certificate of coverage ("certificate") - A copy of a certificate of insurance, a certificate of authority to self-insure issued by the commission, or a coverage

agreement (TWCC-81, TWCC-82, TWCC-83, or TWCC-84), showing statutory workers' compensation insurance coverage for the person's or entity's employees providing services on a project, for the duration of the project.

Duration of the project - includes the time from the beginning of the work on the project until the Contractor's/person's work on the project has been completed and accepted by the governmental entity.

Persons providing services on the project ("subcontractor" in §406.096) - includes all persons or entities performing all or part of the services the Contractor has undertaken to perform on the project, regardless of whether that person contracted directly with the Contractor and regardless of whether that person has employees. This includes, without limitation, independent Contractors, subcontractors, leasing companies, motor carriers, owner-operators, employees of any such entity, or employees of any entity which furnishes persons to provide services on the project. "Services" include, without limitation, providing, hauling, or delivering equipment or materials, or providing labor, transportation or other service related to a project. "Services" does not include activities unrelated to the project, such as food/beverage vendors, office supply deliveries and delivery of portable toilets.

2. The Contractor shall provide coverage, based on proper reporting of classification codes and payroll amounts and filing of any coverage agreements, which meets the statutory requirements of Texas Labor Code, Section 401.011(44) for all employees of the Contractor providing services on the project, for the duration of the project.
3. The Contractor must provide a certificate of coverage to the governmental entity prior to being awarded the contract.
4. If the coverage period shown on the Contractor's current certificate of coverage ends during the duration of the project, the Contractor must, prior to the end of the coverage period, file a new certificate of coverage with the governmental entity showing that coverage has been extended.
5. The Contractor shall obtain from each person providing services on a project, and provide to the governmental entity:
 - a. a certificate of coverage, prior to that person beginning work on the project, so the governmental entity will have on file certificates of coverage showing coverage for all persons providing services on the project; and
 - b. no later than seven (7) days after receipt by the Contractor, a new certificate of coverage showing extension of coverage, if the coverage period shown on the current certificate of coverage ends during the duration of the project.
6. The Contractor shall retain all required certificates of coverage for the duration of the project and for two (2) year thereafter.
7. The Contractor shall notify the governmental entity in writing by certified mail or personal delivery, within ten (10) days after the Contractor knew or should have

known, of any change that materially affects the provision of coverage of any person providing services on the project.

8. The Contractor shall post on each project site a notice, in the text, form and manner prescribed by the Texas Workers' Compensation Commission, informing all persons providing services on the project that they are required to be covered, and stating how a person may verify coverage and report lack of coverage.
9. The Contractor shall contractually require each person with whom it contracts to provide services on a project, to:
 - a. provide coverage, based on proper reporting of classification codes and payroll amounts and filing of any coverage agreements, which meets the statutory requirements of Texas Labor Code, Section 401.011(44) for all of its employees providing services on the project, for the duration of the project;
 - b. provide to the Contractor, prior to that person beginning work on the project, a certificate of coverage showing that coverage is being provided for all employees of the person providing services on the project, for the duration of the project;
 - c. provide the Contractor, prior to the end of the coverage period, a new certificate of coverage showing extension of coverage, if the coverage period shown on the current certificate of coverage ends during the duration of the project;
 - d. obtain from each other person with whom it contracts, and provide to the Contractor:
 1. a certificate of coverage, prior to the other person beginning work on the project; and
 2. a new certificate of coverage showing extension of coverage, prior to the end of the coverage period, if the coverage period shown on the current certificate of coverage ends during the duration of the project;
 - e. retain all required certificates of coverage on file for the duration of the project and for one (1) year thereafter;
 - f. notify the governmental entity in writing by certified mail or personal delivery, within ten (10) days after the person knew or should have known, of any change that materially affects the provision of coverage of any person providing services on the project; and
 - g. contractually require each person with whom it contracts, to perform as required by paragraphs 1 – 7 above, with the certificates of coverage to be provided to the person for whom they are providing services.
10. By signing this contract or providing or causing to be provided a certificate of coverage, the Contractor is representing to the governmental entity that all employees of the Contractor who will provide services on the project will be covered by workers'

compensation coverage for the duration of the project, that the coverage will be based on proper reporting of classification codes and payroll amounts, and that all coverage agreements will be filed with the appropriate insurance carrier or, in the case of a self-insured, with the commission's Division of Self-Insurance Regulation. Providing false or misleading information may subject the Contractor to administrative penalties, criminal penalties, civil penalties, or other civil actions.

11. The Contractor's failure to comply with any of these provisions is a breach of contract by the Contractor which entitles the governmental entity to declare the contract void if the Contractor does not remedy the breach within ten (10) days after receipt of notice of breach from the governmental entity.
 - A. It is understood and acknowledged by both parties that the minimum amounts for insurance, as provided for herein may be adjusted from time to time due to changing conditions to cover City's needs as determined by its Risk Manager.
 - B. Any of the insurance policies required under this section may be written in combination with any of the others, where legally permitted, but none of the specified limits may be lowered thereby.

11-07 INDEMNIFICATION: Contractor does hereby agree to waive all claims, release, indemnify, defend and hold harmless the City of Arlington and all of its officials, officers, agents, employees, in both their public and private capacities, from and against any and all liability, claims, losses, damages, suits, demands or causes of action including all expenses of litigation and/or settlement, court costs and attorney fees which may arise by reason of injury to or death of any person or for loss of, damage to, or loss of use of property occasioned by error, omission, or negligent act of Contractor, his or her officers, agents, employees, subcontractors, invitees or any other persons, arising out of or in connection with the performance of this contract, and Contractor will at his or her own cost and expense defend and protect City of Arlington from any and all such claims and demands. Contractor does hereby agree to waive all claims, release, indemnify, defend and hold harmless City of Arlington and all its officials, officers, agents, and employees, from and against any and all claims, losses, damages, suits, demands or causes or action, and liability of every kind including all expenses of litigation and/or settlement, court costs and attorneys fees for injury or death of any person or for loss of, damage to, or loss of use of any property, arising out of or in connection with the performance of this contract. Such indemnity shall apply whether the claims, losses, damages, suits, demands or causes of action arise in whole or in part from the negligence of the City of Arlington, his or her officers, officials, agents or employees. It is the express intention of all the parties that the indemnity provided for in this paragraph is indemnity by Contractor to indemnify and protect City of Arlington from the consequences of City of Arlington's own negligence, whether that negligence is a sole or concurring cause of the injury, death or damage and whether said negligence is characterized as sole, contractual comparative, concurrent, joint, gross, active, passive, or any other form of negligence.

In any and all claims against any party indemnified hereunder by any employee of the Contractor, any subcontractor, anyone directly or indirectly employed by any of them or anyone for whose acts any of them may be liable, this indemnification obligation shall not be

limited in any way by any limitation on the amount or type of damages, compensation or benefits payable by or for the Contractor or any subcontractor under workmen's compensation acts or other employee benefit acts.

11-08 RIGHT TO AUDIT:

- A. Contractor agrees that City shall, until the expiration of three (3) years after final payment under this contract, have access to and the right to examine any directly pertinent books, documents, papers and records of Contractor involving transactions relating to this contract. Contractor agrees that City shall have access during normal working hours to all necessary Contractor facilities and shall be provided adequate and appropriate work space in order to conduct audits in compliance with the provisions of this section. City shall give Contractor reasonable advance notice of intended audits.

- B. Contractor further agrees to include in subcontract(s), if any, a provision that any subcontractor agrees that City shall have access to and the right to examine any directly pertinent books, documents, papers and records of such subcontractor involving transactions to the subcontract, and further, that City shall have access during normal working hours to all subcontractor facilities, and shall be provided adequate and appropriate work space, in order to conduct audits in compliance with the provisions of this paragraph.

11-09 SALES TAX EXEMPTION: The Contractor is responsible for understanding Texas law regarding tax exemption for City projects and bidding accordingly. The latest information can be obtained from the State Comptroller's Office and/or other appropriate entities.

11-10 CONTRACTOR PERSONNEL:

- A. The Prime Contractor shall provide phone number(s) of superintendent(s) available twenty-four (24) hours a day to handle any emergencies that may occur. (Rev. 3/2019)

- B. The Prime Contractor shall provide a superintendent authorized to receive and fulfill instructions from the Inspector at all times on the job site. Superintendent must: (Rev. 3/2019)
 - 1. Serve as the Contractor's primary point of contact.
 - 2. Be a permanent staff employee.
 - 3. Be knowledgeable of the specifications herein and common construction practices.
 - 4. Be responsible for the performance of the crew(s).
 - 5. Be responsible for the day to day operations in accordance to the service requirements throughout the term of the contract.
 - 6. Make decisions and receive, follow, give, and understand written and verbal instructions in English, and inspect the work site with City upon request.
 - 7. Provide copy of the monthly pay estimate/quantity to the Inspector on the spreadsheet provided by the City.

8. Upload MWBE Reporting to the City's Diversity Management System (B2Gnow).
- C. The City recognizes that events beyond the control of the Contractor (such as death, physical or mental incapacity, long-term illness, or the voluntary termination of employment of the on-site supervisor) will require the Contractor to propose a replacement. In the event that such replacement is necessary, the Contractor agrees that no personnel shall begin work on the project without written approval from the City.
- D. The Contractor shall employ only competent, efficient workmen and shall not use any unfit person or one that is not skilled in the work assigned to him. The Contractor shall at all times maintain good order among his/her employees.
- E. Whenever the City informs the Contractor in writing that, in his/her opinion, any employee is unfit, unskilled, disobedient or is disrupting the orderly progress of the work, such employee shall be removed from the project. The City may orally require immediate removal of an employee for cause, to be followed by written confirmation.

11-11 MOBILIZATION AND BONDS: A lump sum bid item in the amount designated in the PROPOSAL has been included for compensation for mobilization and bonds. This item is a one-time pay item per project and will not be paid per location unless otherwise stated in the PROPOSAL. Upon presentation of a paid invoice for the required bonds, the Contractor will be paid that amount from the amount stated in the PROPOSAL. However, a monthly pay estimate will not be processed solely for paying these items. Work on other pay items must be initiated prior to processing the first monthly pay estimate. The remaining amount of the lump sum will be paid when ten percent (10%) of the amount for the original construction items is earned.

11-12 SUBMITTALS:

- A. Contractor shall submit plans or product data to City for review and approval prior to the purchase or fabrication of any equipment or material for use on this project.
- B. Submittals shall include but not limited to the following:
- Concrete Design
 - Asphalt Design
 - Water/Sanitary Sewer Products
 - Trench Safety
 - Traffic Control Plans (1 hard copy)
 - SWPPP (2 hard copies)
- C. Submittal shall include all appropriate catalog cut sheets, shop drawings, product specifications, and other product documentation as requested by the City. Shop drawings and other necessary data for all non-catalog or custom-made items, shall be sealed or certified accordingly. Unless otherwise noted, submittals should be in electronic format.
- D. In order to facilitate review, the Contractor shall clearly label each item of submittal data with the bid item number which it applies to. Each submittal shall contain sufficient information and details to permit full evaluation of the item and its interrelationship with

other items. Submittals that, in the judgment of the City, are insufficient to permit proper evaluation, will not be reviewed.

- E. Items that are "rejected" are judged to be basically unacceptable and the Contractor shall proceed immediately to identify new items or redesign said items and resubmit them for review.
- F. The Contractor shall allow a fourteen (14) business day review period for each package of submittal information. No time extensions will be granted to the Contractor as a result of re-occurring incomplete or unacceptable submittals or resubmittals.
- G. Review and acceptance of the submittal data by the City shall not relieve the Contractor of his/her obligation to furnish and install the work in accordance with the contract documents.

11-13 CONSTRUCTION MEETING: A pre-construction meeting will be held prior to the issuance of the Notice to Proceed. The purpose of this meeting is to cover all aspects of the project. Issues will be discussed related to the chain-of-command, areas of special concern, and coordination expectations. Weekly or bi-weekly project construction meetings may be held for this project. The City will schedule the time and location; and determine the frequency of these meetings. A representative of the Contractor, knowledgeable of the project, shall attend these construction meetings.

11-14 PUBLIC MEETING: Prior to start of construction, a public meeting will be held for this project. The purpose of the meeting will be to explain the project and answer questions to affected citizens and/or businesses. A representative of the Contractor, knowledgeable of the project, shall attend the public meeting. The representative will be introduced and will be called on as necessary to assist in answering questions.

11-15 TIME FOR COMPLETION AND LIQUIDATED DAMAGES: Since time is of the essence, the City has seen fit to establish the time required to complete this project. The time, as set out in SECTION 6 of this contract, will be the maximum number of **calendar** days allowed to substantially complete this project. Substantially complete is defined as having completed all bid items included in the contract to allow the facilities to function as designed. Failure of the Contractor to complete the work within this time will result in damages being sustained by the City. Such damages are, and will continue to be, impracticable and extremely difficult to determine. The Contractor will pay the City one thousand dollars (**\$1,000**) for each **calendar** day of delay (including Sundays and holidays) in finishing the work in excess of time specified for completion, plus any authorized time extensions. Execution of the contract under these specifications shall constitute agreement by the City and Contractor that one thousand dollars (**\$1,000**) is the minimum value of the costs and actual damage caused by failure of the Contractor to complete the work within the allotted time, that such sum is liquidated damages and shall not be construed as a penalty, and that such sum may be deducted from payments due the Contractor if such delay occurs.

11-16 BONUS: N/A

11-17 COMPUTATION OF CONTRACT TIME FOR COMPLETION & DELAYS:

- A. Time will be charged for all calendar days regardless of weather conditions, material supplies, or other conditions not under the control of the Contractor, which could impede the progress of the work. Time will also be charged for Sundays and holidays.
- B. Prior to beginning construction operations, the Contractor shall submit to the City a critical path method (CPM) chart progress schedule showing the manner of prosecution of the work that he intends to follow in order to complete the contract within the allotted time. The purpose for this schedule is to assure adequate planning and execution of the work. The progress schedule must present a reasonable approach to completing the work within the allotted time.
- C. Payment of partial monthly estimates will not be processed until the CPM chart progress schedule has been approved by the City.
- D. The Contractor shall be entirely responsible for maintaining the progress of the work in accordance with the approved schedule. Should it become evident, in the opinion of the City, any time during the construction that the progress of the work has not been maintained in accordance with the approved schedule, the Contractor shall, upon written request by the City, promptly submit a revised schedule. This revised schedule shall set out operations, methods, equipment, added labor, and additional work shifts by which time lost shall be made up. At the end of each estimate period, the City will determine whether the Contractor is in compliance with the approved schedule, or the approved revised schedule. In the event the Contractor is determined not to be in compliance, he/she will be notified immediately in writing. If the Contractor does not correct the work progress to comply with the approved revised schedule by the end of the month of notification, payment for work performed during the period of non-compliance will be reduced according to the following:
- 1st Month - Reduction = 30% X work performed (Month Only)
 - 2nd Month - Reduction = 40% X work performed (Month Only)
 - 3rd Month - Reduction = 50% X work performed (Month Only)
 - Subsequent Month - Reduction = 50% work performed (Month Only)
- E. The first month (the month of notification) is that month in which notification is made. Each month's reduction will be assessed only for that work performed during that specific month. The reduction will be cumulative for the entire period of non-compliance; i.e., thirty percent (30%) payment reduction for the work performed during the first month, plus forty percent (40%) payment reduction for work performed during the second month, plus fifty percent (50%) payment reduction for work performed during the third month, and plus fifty percent (50%) payment reduction for work performed in each succeeding month of non-compliance thereafter. When the work progress becomes in compliance with the approved schedule, or the approved revised schedule, all withheld monies will be paid to the Contractor with the next regular estimate.
- F. The Contractor shall anticipate possible delays and shall be prepared to supplement and revise his/her construction methods accordingly. The Contractor assumes the risk of all suspensions of or delays in performance of the contract, regardless of length thereof, arising from all causes whatsoever, whether or not relating to this contract, including wrongful

acts or omissions of the City or its Contractors or subcontractors except only to the extent, if any, that compensation or an extension of time may be due as expressly provided for elsewhere in this contract for such suspension or delays, and, subject only to such exception, the Contractor shall bear the burden of all costs, expenses and liabilities which he/she may incur in connection with such suspensions or delays, and all such suspensions, delays, costs, expenses and liabilities of any nature whatsoever, whether or not provided for in this contract, shall conclusively be deemed to have been within the contemplation of the parties.

- G. Notwithstanding any provisions of this contract, whether relating to time of performance or otherwise, City makes no representation or guarantee as to when the construction site or any part thereof will be available for the performance of the contract, or as to whether conditions at the construction site will be such as to permit the contract to be performed thereon without interruption or by any particular sequence or method or as to whether the performance of the contract can be completed by the time required under this contract or by any other time.
- H. Wherever in connection with this contract it is required, expressly or otherwise, that City shall perform any act relating to the contract, including making available or furnishing any real property, materials or other things, no guarantee is made by the City as to the time of such performance and the delay of City in fulfilling such requirement shall not result in liability of any kind on the part of City except only to the extent, if any, that an extension of time or compensation may be due as expressly provided for in this contract.
- I. If the contract requires unforeseen work or work and materials in greater amounts than those set forth in the contract, then additional calendar days may be considered at the discretion of the City. However, the completion time can only be changed by the execution of a signed agreement. An extension of time will only be considered when a claim for such extension is submitted to the City in writing by the Contractor within fourteen (14) calendar days from the time when any alleged cause of delay occurs.

11-18 CONSTRUCTION CONTINGENCY ALLOWANCE: A construction contingency allowance, in the amount designated in the PROPOSAL, is provided to allow for expeditious handling of unforeseen conditions that may arise during the course of the Project and may only be used with the concurrence of the City. Before contingency work is performed, the Contractor shall submit a proposed price for the work to the City and shall obtain written approval before proceeding with the additional work. Any balance of funds remaining in the construction contingency allowance at the close of the project belong to and shall remain with the City.

11-19 MATERIALS AND WORKMANSHIP: WARRANTIES AND GUARANTEES: Under the terms of the warranties which arise from these contract documents and/or by the terms of any applicable special warranties required by the contract documents, if any of the work in accordance with this contract is found to not be in accordance with the requirements of the contract documents, the Contractor shall correct such work promptly after receipt of written notice from the City or other entity as the contract documents may provide. This obligation shall survive acceptance of the work under the contract and termination of the contract. If Contractor fails within a reasonable time after written notice to correct defective work or to remove and replace rejected work, or if Contractor fails to perform the work in accordance with the contract

documents, or if Contractor fails to comply with any provision in the contract document, either the City or its designee may, after seven (7) days written notice to Contractor, correct and remedy any such deficiency at the expense of the Contractor.

11-20 DEFECTIVE MATERIALS, EQUIPMENT OR, IN-PLACE CONSTRUCTION:

- A. Materials and equipment not conforming to the requirements of these specifications will be rejected and shall be removed immediately from the site of the work, unless permitted to remain by the Inspector. Rejected materials, the defects of which have been subsequently corrected, shall be considered as new material.
- B. In-place construction not conforming to the requirements of these specifications will be removed and replaced/reworked at the Contractor's expense as deemed appropriate by the City. Tests made on in-place construction which has been replaced or reworked due to failure to meet project specifications will be authorized by the City and the cost of such tests will be the expense of the Contractor. Testing will be performed by testing company under contract with the City at the rates specified by that contract.

11-21 QUALITY ASSURANCE/QUALITY CONTROL (QA/QC):

- A. The City shall have the authority to test materials, equipment and in-place construction to verify compliance with project specifications. Unless otherwise noted within these Special Provisions, the expense of testing shall be paid for by the City.
- B. If there are any failing tests, the Contractor shall be responsible for all cost of additional testing until compliant. The failure of the City to make any tests shall in no way relieve the Contractor of his/her responsibility to provide materials, equipment, and in-place construction which comply with project specifications.
- C. The Contractor shall provide such facilities as the City may require for collecting and forwarding samples and shall not, without specific written permission of the City, use the materials represented by the samples until tests have been made and materials approved for use. The Contractor will furnish adequate samples without charge to the City.
- D. All testing shall be coordinated through the Inspector. Results of tests shall be based on findings by the City's contracted testing facility.

11-22 SAFETY DATA SHEET: Contractor shall provide a copy of Safety Data Sheets (SDS), product specifications, Manufacturer's warranty, and application instructions to City for approval prior to commencing work, if applicable. (Rev 9/2019)

11-23 SATURDAY OR CITY HOLIDAY INSPECTION:

- A. In an effort to limit face-to-face contact and maintain continuing operations, the City will accept credit card payments over the phone for Saturday/Holiday Inspection fees. (Rev. 4/2020)
- B. Any Contractor requiring the services of an Inspector on Saturdays will be charged a flat rate of \$40.00 per hour for inspection services. In addition, the Contractor will also be required to pay a non-refundable \$100.00 deposit to the City. Contactors will notify the Department of Public Works and Transportation by 4:30 PM on the preceding Thursday at

817-459-6550 to request Saturday/Holiday Inspection Services. If the request is not submitted by the deadline, the Contractor will not be able to work on the requested Saturday/Holiday. City Staff from the Planning and Development Department will contact the Contractor Friday by 10:00 AM to process a credit card over the telephone. For each transaction, there is a 2.75% third party credit card processing fee. This is not a city fee. A receipt will be emailed to the Contractor. (Rev. 4/2020)

- C. Following the performance of inspection services, an invoice will be prepared and mailed to the Contractor. The \$100.00 deposit will be deducted from the total invoice amount. All invoices must be paid in order for the Contractor to receive the retained funds at the termination of a project, and/or to receive a final project acceptance.
- D. The Contractor will be charged only for the hours worked. If the Contractor works only 2.5 hours, no invoice will be generated (2.5 hours x \$40 = \$100 deposit already received). If an Inspector watches several projects and the remitted deposits equal or surpass the amount needed to pay for his or her hours, no invoices will be delivered. However, if the \$100.00 deposit is delivered and the Contractor is unable to work for any reason, including weather, the \$100.00 fee will not be refunded.
- E. Construction Services management will determine the appropriate number of Inspectors necessary and which Inspectors will work on each Saturday.
- F. No money will be exchanged in the field.
- G. Overtime during the work week is not subjected to the required process listed above. Night time tie-ins are also exempt from these rules when they are done in an effort to reduce the impact of water outages to customers.
- H. No work will be permitted on Sundays without prior approval from the Construction Services Manager. If approved to work on Sunday, the Saturday inspection rates will apply.
- I. Holiday Schedule
 - 1. Below are holidays observed by the City of Arlington. No work will be permitted except in the most extreme circumstances and with prior approval from the Construction Services Manager. If approved to work on a holiday, the Saturday inspection rates will apply.
 - » Martin Luther King Day (third Monday in January)
 - » President's Day (third Monday in February)
 - » Good Friday (Friday preceding Easter)
 - » New Year's Day (January 1)
 - » Memorial Day (Last Monday in May)
 - » Independence Day (July 4)
 - » Labor Day (First Monday in September)
 - » Thanksgiving Day (Fourth Thursday in November)
 - » Thanksgiving Friday (Friday after Thanksgiving Day)
 - » Christmas Eve (December 24)

» Christmas Day (December 25)

2. In addition to the above, any holiday that falls on a Saturday will be observed on the preceding Friday. Any holiday that falls on Sunday will be observed on the following Monday. If a holiday falls on a Friday or on a Monday, the Contractor will not be permitted to work on the Saturday after or preceding the holiday.

11-24 WORK PERFORMED WITHOUT BENEFIT OF INSPECTION:

- A. **Contractor shall provide the City 24 hours notice prior to any construction.** Any time work is being performed on bid items, work that supports bid items, or work that requires lane closures, an Inspector must be present. Work performed without the proper inspection will be consider unauthorized, and at the option of the Construction Services Manager may not be measured and paid for and may require removal at the Contractor's expense.
- B. If the Contractor fails to satisfactorily repair, replace or remove the unauthorized work or materials immediately upon receipt of written notice, the City will have authority to cause such remediation to be performed and to deduct the cost thereof from any monies due or to become due to the Contractor.
- C. If there is ever any question as to what requires inspection, please check with the assigned Inspector, Inspector Supervisor, or Construction Services Manager. General clean-up and similar items of work that have no direct pay can be performed without the benefit of inspection.

11-25 MONTHLY ESTIMATE:

- A. Monthly pay estimates will be processed at the beginning of each month for work performed during the prior month. Monthly pay estimates shall be submitted no later than the 1st day of each month. Assuming there are no issues encountered during the standard process, payment will be processed within thirty (30) days from the end of the prior month.
(Rev. 9/2020)
- B. Where multiple locations are included in the contract, City may require measurements to be performed on a daily basis. The Contractor is required to be present whenever (monthly or final) quantities are measured by the Inspector. The Inspector will coordinate with the Contractor to schedule a mutually agreeable date and time (including Saturdays) to perform the measuring. If the Contractor chooses not to be present when quantities are measured by the Inspector, the Contractor agrees to accept the Inspector's measurements. Invoices shall be submitted for the actual work performed.
- C. Submittal of monthly pay estimate shall include:
 - » Spreadsheet of itemized request (form provided by City)
 - » SWPPP Report
 - » Monthly Payment Breakdown (form provided by the City)
 - » Invoices
 - » Tickets
 - » Other supporting documentation (where applicable or as required by the City)

- D. Submittal of monthly pay estimate to the City's Diversity Management System (B2Gnow), including all payments to subcontractors on the Contract no later than 5 business days after City has agreed on quantities in monthly estimate.
- E. Failure to submit by the deadline or without the required documents will result in the pay estimate being processed in the following month.

11-26 OWNER NOTIFICATION:

- A. When work performed has the potential of disrupting businesses or homestead, including but not limited to water cutoff or driveway reconstruction, Contractor shall notify the business owners, occupants and residents in writing forty-eight (48) hours prior to commencing work. It is incumbent upon the Contractor to provide and place door hangers by the required time. Cost for producing the door hangers shall be subsidiary to various bid items.
- B. Door hangers shall be printed in color, in English & Spanish, on 65 pound, white card stock paper and be designed as indicated below. Any deviation will require prior approval from the City. The City will provide a full scaled colored pdf version of the doorhangers to the successful contractor for production.

(Rev 1/2019)

LIMITED STREET PARKING



LIMITED STREET PARKING



Hello!

We are making progress on your street's project and need your help to finish it!

How does this construction affect me?

The City of Arlington is making improvements in your neighborhood. With that improvement comes construction. This construction may at times affect access in and around your street.

What do I need to do?

To help ensure that this project is completed in a timely fashion with minimal interruptions and to prevent damage to your personal vehicles, **please remove any vehicles, trailers, etc. that may interfere with the construction process and avoid parking on the street**, Monday through Friday from 7:00 a.m. to 5:00 p.m. on

Date	To Date
------	---------

Please remember to tell any guest visiting you about this parking limitation.

What happens if I am unable to move my vehicles?

If vehicles are not moved, the towing of vehicles will be at the owner's expense of at least \$200 (Article XIV, Section 14.04 Streets and Sidewalks).

Who can I talk to?

For any additional information or questions, please contact the following contractor or City staff member.

Contractor Name	
Contractor Phone Number	
City Inspector	
City Inspector Phone Number 817-459-6550	Date

We appreciate your cooperation and apologize for any inconvenience this may cause. The City of Arlington appreciates your help in moving this project forward!

Hello!

We are making progress on your street's project and need your help to finish it!

How does this construction affect me?

The City of Arlington is making improvements in your neighborhood. With that improvement comes construction. This construction may at times affect access in and around your street.

What do I need to do?

To help ensure that this project is completed in a timely fashion with minimal interruptions and to prevent damage to your personal vehicles, **please remove any vehicles, trailers, etc. that may interfere with the construction process and avoid parking on the street**, Monday through Friday from 7:00 a.m. to 5:00 p.m. on

Date	To Date
------	---------

Please remember to tell any guest visiting you about this parking limitation.

What happens if I am unable to move my vehicles?

If vehicles are not moved, the towing of vehicles will be at the owner's expense of at least \$200 (Article XIV, Section 14.04 Streets and Sidewalks).

Who can I talk to?

For any additional information or questions, please contact the following contractor or City staff member.

Contractor Name	
Contractor Phone Number	
City Inspector	
City Inspector Phone Number 817-459-6550	Date

We appreciate your cooperation and apologize for any inconvenience this may cause. The City of Arlington appreciates your help in moving this project forward!



ESTACIONAMIENTO LIMITADO EN LA CALLE

¡Hola!

Estamos progresando en el proyecto de su calle y necesitamos su ayuda para terminar.

¿Como me afecta la construcción?

La City of Arlington esta mejorando su barrio. Con el mejoramiento viene construcción. Esta construcción puede afectar el acceso de su calle y las calles alrededor.

¿Que necesito hacer?

Para garantizar que este proyecto se termine a tiempo con minimas interrupciones y para prevenir los daño a su vehículo, **por favor de mover sus vehículos, trailas, etc. que puede interferir con el proceso de construcción y evitar estacionar en el calle**, Lunes a Viernes de las 7:00 AM a 5:00PM

Fecha	Hasta Fecha
-------	-------------

Por favor recuerda informar a sus visitantes de el estacionamiento limitado.

¿Que pasa si no puedo mover mi vehículo?

Si los vehículos no se han movido, vehiculos estacionados seran remolcados y será la responsabilidad financiera de el dueño de los gastos con minimo de \$200 (Article XIV, Section 14.04 Streets and Sidewalks).

¿A quien puedo hablar?

Para información adicional o preguntas, por favor llama al siguiente contratista o personal de la ciudad.

Nombre de contratista	
Telefono de contratista	
Inspector de la ciudad	
Telefono de Inspector 817-459-6550	Fecha

Apreciamos su cooperación y nos disculpamos por la inconveniencia que esto puede causar. ¡La City of Arlington apreciamos su ayuda en el avance del proyecto!



ESTACIONAMIENTO LIMITADO EN LA CALLE

¡Hola!

Estamos progresando en el proyecto de su calle y necesitamos su ayuda para terminar.

¿Como me afecta la construcción?

La City of Arlington esta mejorando su barrio. Con el mejoramiento viene construcción. Esta construcción puede afectar el acceso de su calle y las calles alrededor.

¿Que necesito hacer?

Para garantizar que este proyecto se termine a tiempo con minimas interrupciones y para prevenir los daño a su vehículo, **por favor de mover sus vehículos, trailas, etc. que puede interferir con el proceso de construcción y evitar estacionar en el calle**, Lunes a Viernes de las 7:00 AM a 5:00PM

Fecha	Hasta Fecha
-------	-------------

Por favor recuerda informar a sus visitantes de el estacionamiento limitado.

¿Que pasa si no puedo mover mi vehículo?

Si los vehículos no se han movido, vehiculos estacionados seran remolcados y será la responsabilidad financiera de el dueño de los gastos con minimo de \$200 (Article XIV, Section 14.04 Streets and Sidewalks).

¿A quien puedo hablar?

Para información adicional o preguntas, por favor llama al siguiente contratista o personal de la ciudad.

Nombre de contratista	
Telefono de contratista	
Inspector de la ciudad	
Telefono de Inspector 817-459-6550	Fecha

Apreciamos su cooperación y nos disculpamos por la inconveniencia que esto puede causar. ¡La City of Arlington apreciamos su ayuda en el avance del proyecto!

LIMITED DRIVEWAY ACCESS



Hello!

We are making progress on your street's project and need your help to finish it!

How does this construction affect me?

The City of Arlington is making improvements in your neighborhood. With that improvement comes construction, which may at times affect access in and around street.

What do I need to do?

To help ensure that this project is completed in a timely fashion with minimal interruptions and to prevent damage to your personal vehicles, **please remove any vehicles, trailers, etc. that may interfere with the construction process of your driveway and avoid parking on the street**, Monday through Friday from 7:00 a.m. to 5:00 p.m. on

Date	To Date

Your driveway will be closed during this time.

Please remember to tell any guest visiting you about this parking limitation.

What happens if I am unable to move my vehicles?

If vehicles are not moved, the towing of vehicles will be at the owner's expense of at least \$200 (Article XIV, Section 14.04 Streets and Sidewalks).

Who can I talk to?

For any additional information or questions, please contact the following contractor or City staff member.

Contractor Name	
Contractor Phone Number	
City Inspector	
City Inspector Phone Number 817-459-6550	Date

We appreciate your cooperation and apologize for any inconvenience this may cause. The City of Arlington appreciates your help in moving this project forward!

LIMITED DRIVEWAY ACCESS



Hello!

We are making progress on your street's project and need your help to finish it!

How does this construction affect me?

The City of Arlington is making improvements in your neighborhood. With that improvement comes construction, which may at times affect access in and around your street.

What do I need to do?

To help ensure that this project is completed in a timely fashion with minimal interruptions and to prevent damage to your personal vehicles, **please remove any vehicles, trailers, etc. that may interfere with the construction process of your driveway and avoid parking on the street**, Monday through Friday from 7:00 a.m. to 5:00 p.m. on

Date	To Date

Your driveway will be closed during this time.

Please remember to tell any guest visiting you about this parking limitation.

What happens if I am unable to move my vehicles?

If vehicles are not moved, the towing of vehicles will be at the owner's expense of at least \$200 (Article XIV, Section 14.04 Streets and Sidewalks).

Who can I talk to?

For any additional information or questions, please contact the following contractor or City staff member.

Contractor Name	
Contractor Phone Number	
City Inspector	
City Inspector Phone Number 817-459-6550	Date

We appreciate your cooperation and apologize for any inconvenience this may cause. The City of Arlington appreciates your help in moving this project forward!



ACCESO LIMITADO EN LA ENTRADA DE VEHÍCULO

¡Hola!

Estamos progresando en el proyecto de su calle y necesitamos su ayuda para terminar.

¿Como me afecta la construcción?

La City of Arlington esta mejorando su barrio. Con el mejoramiento viene construcción. Esta construcción puede afectar el acceso de su calle y las calles alrededor.

¿Que necesito hacer?

Para garantizar que este proyecto se termine a tiempo con minimas interrupciones y para prevenir daño a su vehículo, **por favor de mover sus vehículos, trailas, etc. que puede interferir con la construcción de su entrada de vehículo y evitar estacionar en el calle, Lunes a Viernes de las 7:00 AM a 5:00PM**

Fecha	Hasta Fecha
-------	-------------

No tendra acceso a su entrada de vehículos durante este tiempo.

Por favor recuerda informar a sus visitantes de el estacionamiento limitado.

¿Que pasa si no puedo mover mi vehículo?

Si los vehículos no se han movido, vehiculos estacionados seran remolcados y será la responsabilidad financiera de el dueño de los gastos con minimo de \$200 (Article XIV, Section 14.04 Streets and Sidewalks).

¿A quien puedo hablar?

Para información adicional o preguntas, por favor llamar al siguiente contratista o personal de la ciudad.

Nombre de contratista	
Telefono de contratista	
Inspector de la ciudad	
Telefono de Inspector 817-459-6550	Fecha

Apreciamos su cooperación y nos disculpamos por la inconveniencia que esto puede causar. ¡La City of Arlington apreciamos su ayuda en el avance del proyecto!



ACCESO LIMITADO EN LA ENTRADA DE VEHÍCULO

¡Hola!

Estamos progresando en el proyecto de su calle y necesitamos su ayuda para terminar.

¿Como me afecta la construcción?

La City of Arlington esta mejorando su barrio. Con el mejoramiento viene construcción. Esta construcción puede afectar el acceso de su calle y las calles alrededor.

¿Que necesito hacer?

Para garantizar que este proyecto se termine a tiempo con minimas interrupciones y para prevenir daño a su vehículo, **por favor de mover sus vehículos, trailas, etc. que puede interferir con la construcción de su entrada de vehículo y evitar estacionar en el calle, Lunes a Viernes de las 7:00 AM a 5:00PM**

Fecha	Hasta Fecha
-------	-------------

No tendra acceso a su entrada de vehículos durante este tiempo.

Por favor recuerda informar a sus visitantes de el estacionamiento limitado.

¿Que pasa si no puedo mover mi vehículo?

Si los vehículos no se han movido, vehiculos estacionados seran remolcados y será la responsabilidad financiera de el dueño de los gastos con minimo de \$200 (Article XIV, Section 14.04 Streets and Sidewalks).

¿A quien puedo hablar?

Para información adicional o preguntas, por favor llamar al siguiente contratista o personal de la ciudad.

Nombre de contratista	
Telefono de contratista	
Inspector de la ciudad	
Telefono de Inspector 817-459-6550	Fecha

Apreciamos su cooperación y nos disculpamos por la inconveniencia que esto puede causar. ¡La City of Arlington apreciamos su ayuda en el avance del proyecto!

UPCOMING WATER SHUTOFF



The City of Arlington is working to improve water services to your neighborhood and will be performing necessary utility work that requires turning off your water.

When will my water be turned off?

From	To
On	
Comments	

How can I get updates?

Go to www.arlingtontx.gov/wateroutages or sign up for email notifications by registering your account at www.arlingtontx.gov/wateronline.

Who can I talk to?

For any additional information or questions, please contact the following contractor or City staff member.

Contractor Name	
Contractor Phone Number	
City Inspector	Time
City Inspector Phone Number 817-459-6550	Date

We appreciate your cooperation and apologize for any inconvenience this may cause. This work is necessary for the enhancement of your neighborhood and the City of Arlington.

UPCOMING WATER SHUTOFF



The City of Arlington is working to improve water services to your neighborhood and will be performing necessary utility work that requires turning off your water.

When will my water be turned off?

From	To
On	
Comments	

How can I get updates?

Go to www.arlingtontx.gov/wateroutages or sign up for email notifications by registering your account at www.arlingtontx.gov/wateronline.

Who can I talk to?

For any additional information or questions, please contact the following contractor or City staff member.

Contractor Name	
Contractor Phone Number	
City Inspector	Time
City Inspector Phone Number 817-459-6550	Date

We appreciate your cooperation and apologize for any inconvenience this may cause. This work is necessary for the enhancement of your neighborhood and the City of Arlington.



APAGADO PROGRAMADO DE AGUA

La City of Arlington esta mejorando el servicio de agua en su barrio y estaremos haciendo las necesarias instalaciones que requiere apagar el servicio de agua.

¿Cuándo se apagará mi servicio de agua?

Desde	Hasta
En	
Comentarios	

¿Como recibo actualizaciones?

Se puede recibir actualizaciones en www.arlingtonx.gov/wateroutages o se puede registrarse en www.arlingtonx.gov/wateronline para recibir notificaciones por correo electrónico.

¿A quien puedo hablar?

Para información adicional o preguntas, por favor llamar al siguiente contratista o personal de la ciudad.

Nombre de contratista	
Telefono de contratista	
Inspector de la ciudad	
Telefono de Inspector 817-459-6550	Fecha

Apreciamos su cooperación y nos disculpamos por la inconveniencia que esto puede causar. ¡La City of Arlington apreciamos su ayuda en el avance del proyecto!



APAGADO PROGRAMADO DE AGUA

La City of Arlington esta mejorando el servicio de agua en su barrio y estaremos haciendo las necesarias instalaciones que requiere apagar el servicio de agua.

¿Cuándo se apagará mi servicio de agua?

Desde	Hasta
En	
Comentarios	

¿Como recibo actualizaciones?

Se puede recibir actualizaciones en www.arlingtonx.gov/wateroutages o se puede registrarse en www.arlingtonx.gov/wateronline para recibir notificaciones por correo electrónico.

¿A quien puedo hablar?

Para información adicional o preguntas, por favor llamar al siguiente contratista o personal de la ciudad.

Nombre de contratista	
Telefono de contratista	
Inspector de la ciudad	
Telefono de Inspector 817-459-6550	Fecha

Apreciamos su cooperación y nos disculpamos por la inconveniencia que esto puede causar. ¡La City of Arlington apreciamos su ayuda en el avance del proyecto!

11-27 SIGNS FOR BUSINESSES:

- A. Weatherproof signs directing motorists to adjacent business entrances shall be provided by the Contractor and used during construction at locations directed by the City. The signs shall be approved by the City prior to fabrication and installation.
- B. The sign shall include the business name, shall be at a minimum of 18-inches by 24-inches and have a minimum of 3-inches tall by 2-inches wide lettering. The sign shall be placed such that it is visible from the street to help direct patrons to adjacent businesses but shall not obstruct traffic visibility for vehicles exiting the driveway.
- C. It will be the Contractor's responsibility to maintain the signs until such time as the City agrees they can be removed. A bid item has been included which shall cover all costs related to fabricating, installing, and maintaining the signs.

11-28 PROJECT SIGNS:

- A. Contractor shall provide and install a minimum of four (4) project signs. Fewer signs may be allowed upon approval by the City.
- B. Generally, project signs shall be located at the beginning and end of the project and on major intersecting streets. Locations of signs and specific information on signs shall be approved by the City prior to fabrication of signs.
- C. Signs shall be in accordance with the appropriate sign detail for the project. Construction shall be on ¾-inch weatherproof (marine), 4-foot x 8-foot plywood and the painting/graphics shall be accomplished with good quality paint which will not weather or fade during the life of the contract. A jpeg file of the graphics is available on the City's web page, <http://www.arlingtontx.gov/details>. Color shall be similar in nature. Any deviation will require prior approval from the City. (Rev 4/2019)
- D. Signs shall be placed in prominent locations and maintained in good condition until the completion of the project. Damaged or defaced signs will be repaired or replaced within two (2) calendar days at the Contractor's expense. The cost of the plywood sign(s) shall be considered subsidiary to the unit prices bid on this project.

11-29 QUANTITIES:

- A. Quantities provided in the plans are superseded by quantities included in this contract. Quantities shown on plan sheets are for guidance only. (Rev. 8/2021)

11-30 CONTRACTOR SELF-PERFORMANCE:

- A. The contractor shall use its own personnel and equipment to perform the primary work type identified in this contract. Primary work includes: water main and serive replacement. Qualified subcontractors may be used to perform any other work types in this contract. (Rev. 8/2021)

END OF SECTION

SECTION NO. 12

SPECIAL PROVISIONS – GENERAL CONSTRUCTION SPECIFICATIONS

NUMERICAL LISTING

Section No.	
12-01	STORMWATER MANAGEMENT CONTROLS
12-02	FILTER FABRICS
12-03	DETOURS AND BARRICADES
12-04	TEMPORARY TRAFFIC SIGNALS
12-05	PROTECTION OF THE PUBLIC
12-06	PROTECTION OF FLOODPLAIN
12-07	PROTECTION OF ADJACENT PROPERTY
12-08	PROTECTION OF ADJACENT LANDSCAPING IMPROVEMENTS
12-09	PROTECTION & CLEANING OF EXISTING STORM OR SANITARY SEWERS
12-10	MAINTENANCE OF ADEQUATE DRAINAGE
12-11	TEMPORARY ACCESS TO PRIVATE PROPERTIES
12-12	CRUSHED STONE BAD WEATHER PROTECTION
12-13	USE OF PRIVATE PROPERTY
12-14	USE OF CITY PARKS
12-15	CONSECUTIVE STREET CONSTRUCTION
12-16	TOWING OF VEHICLES
12-17	CONSTRUCTION WATER
12-18	DAILY CLEANUP & REMOVAL ITEMS
12-19	DUST CONTROL
12-20	MOWING DURING CONSTRUCTION
12-21	EXISTING UTILITIES
12-22	SITE PREPARATION
12-23	TREE REMOVAL
12-24	TREE TRIMMING
12-25	SITE GRADING
12-26	BORROW
12-27	FILLING
12-28	SELECT FILL
12-29	SPRINKLER RELOCATIONS

- 12-30 CRUSHED STONE CUSHION
- 12-31 BACKFILL & BACKFILL MATERIAL
- 12-32 MECHANICALLY COMPACTED BACKFILL
- 12-33 TRENCHLESS TECHNOLOGY
- 12-34 BACKFILL AND CLEANUP
- 12-35 FLOWABLE BACKFILL
- 12-36 TEMPORARY STREET REPAIR
- 12-37 VERTICAL ADJUSTMENT OF WATER VALVES, MANHOLES, ACCESS CHAMBERS AND CLEANOUTS
- 12-38 GREEN CEMENT
- 12-39 REINFORCING STEEL
- 12-40 RESTORATION OF EXISTING PAVED SURFACES
- 12-41 GALVANIZED GABIONS WITH PVC COATING
- 12-42 CONDUIT
- 12-43 SLOPE EROSION CONTROL
- 12-44 TOPSOIL
- 12-45 HYDRO-MULCH SEEDING
- 12-46 SODDING/TURFGRASS PLANTING
- 12-47 FINAL CLEANUP
- 12-48 FINAL INSPECTION

SECTION NO. 12

SPECIAL PROVISIONS – GENERAL CONSTRUCTION SPECIFICATIONS

12-01 STORMWATER MANAGEMENT CONTROLS:

- A. This project is subject to the Texas Commission on Environmental Quality's (TCEQ) Construction General Permit under the Texas Pollutant Discharges Elimination System (TPDES) Program as well as the City's Ordinances. The City is a Municipal Separate Storm Sewer System (MS4) Operator.
- B. The Contractor is considered the Primary Operator and is responsible for the Erosion Control Plan, Stormwater Pollution Prevention Permit (SWPPP), and or Notice of Intent/Notice of Termination (NOI/NOT) as well as ongoing compliance throughout construction. The Contractor shall provide adequate erosion, sedimentation and pollution controls, and shall be solely responsible for day to day operations, inspections, and maintenance of stormwater controls. It shall be the Contractor's responsibility to ensure no sediment leaves the site.
- C. The City is considered the Secondary Operator and has control over specifications, plans and the Erosion Control Plan and/or SWPPP. The Contractor shall comply with all requests by the City for maintenance of stormwater controls or general site maintenance to prevent erosion, sedimentation, or pollution.
- D. The information contained in the Erosion Control Plan, SWPPP, NOI and/or Site Notices shall be in accordance with the TPDES Construction General Permit and City's Ordinances. All plans, permits, and notices shall be submitted to the City for review at least fifteen (15) calendar days prior to commencement of construction activities. Final plans, permits and notices shall be submitted to the City and TCEQ (if applicable). Notices must be posted on site prior to commencement of construction activities.
- E. All plans and permits shall be prepared and certified by a Licensed Professional Engineer or other professional, approved by the City, certified in a discipline that includes erosion and sediment control principles appropriate for the site in accordance with City Ordinances.
- F. For projects that disturb less than twelve thousand (12,000) square feet that are not part of a Larger Common Plan of Development, no submittals are required. Installation, inspection and maintenance of stormwater controls shall be in accordance with standards set forth in the TPDES Construction General Permit.
- G. For projects that disturb between twelve thousand (12,000) square feet and 1-acre that are not part of a Larger Common Plan of Development, the Contractor shall prepare an Erosion Control Plan (if it is not provided in the construction plans). Inspection and maintenance of stormwater controls shall be in accordance with standards set forth in the TPDES Construction General Permit.

- H. For projects that disturb between 1-acre and 5-acres, the Contractor shall provide a site specific SWPPP and two (2) separate Site Notices (one to be signed by the Contractor and one to be signed by the City). The SWPPP shall be prepared and certified by a licensed professional civil engineer or by a certified professional who is familiar with the TCEQ TPDES Construction General Permit requirements. The SWPPP shall be subject to approval by the City and/or TCEQ and shall contain information as required by the TPDES General Permit Regulations and the City's checklist included in the City's Design Criteria Manual.
- I. For projects larger than 5-acres, the Contractor shall provide a site specific SWPPP and two (2) separate Site Notices (one to be signed by the Contractor and one to be signed by the City). The SWPPP shall be prepared and certified by a licensed professional civil engineer or by a certified professional who is familiar with the TCEQ TPDES Construction General Permit requirements. The SWPPP shall be subject to approval by the City and/or TCEQ and shall contain information as required by the TPDES General Permit Regulations and the City's checklist included in the City's Design Criteria Manual. The Contractor shall submit a NOI to TCEQ and obtain a site specific TPDES authorization number prior to the commencement of construction activities. The Contractor shall submit a NOT within thirty (30) days of project completion to TCEQ. Copy of the NOI and NOT must be submitted to the City.
- J. The following shall be maintained on the project site by the Contractor at all times:
1. Post near main entrance to project site or at project site office:
 - a. Site Notices (signed by the Contractor and the City) depending on project size.
 - b. Local contact person with phone number.
 - c. Brief description of project.
 - d. Location of SWPPP (if applicable)
 2. SWPPP including any revisions (if applicable).
- K. **The stormwater controls must be in place on the project prior to any construction activity. Any stockpiles of unusable items and/or excavated materials shall be removed from the project site within seven (7) days.** In case of failure on the part of the Contractor to control soil erosion, pollution and/or siltation, the City reserves the right to employ outside assistance or to use City forces to provide the necessary corrective measures. Such incurred direct costs plus project engineering costs will be billed to the Contractor. Contractor shall not begin work to the detriment of work already begun. Contractor shall conduct operations so as to impose a minimum interference to traffic. Monthly pay estimates to the Contractor may be withheld until Contractor is in compliance.
- L. A lump sum bid item in the amount designated in the PROPOSAL has been to pay the Contractor for SWPPP preparation as well as providing, installing, and maintaining the physical stormwater control measures throughout construction and removal of all items and structures constructed for stormwater pollution protection once vegetation is

established. Twenty five percent (25%) of this amount will be paid on the first monthly pay estimate with the remainder amount prorated equally to the remainder months of the contract time.

- M. Contractor shall provide an electronic file in pdf format of the final SWPPP, including all revisions, inspections and NOT (if applicable) with the final payment estimate.

12-02 FILTER FABRICS:

- A. The filter fabric shall be of a synthetic material that will allow stormwater to freely flow through while trapping sediment and debris. The geotextile shall be non-biodegradable and resistant to degradation by ultraviolet exposure and resistant to contaminants commonly encountered in storm water.
- B. When applicable, the applications and uses of the filter fabric include but are not limited to the selection listed below. The filter fabrics have the following Minimum Average Roll Values (MARV) for physical properties:

			Applications/Uses				
			Silt Fence	Sub-Drain, French Drain	Dewatering	Separation, Pipe Embedment, Concrete Channels, Concrete Slope Protection, Weepholes	Construction Access
Tensile Strength	ASTM D-4632	LBS	100x100	120	200	250	300
CBR Puncture	ASTM D-6241	LBS	250	300	600	700	850
Apparent Opening Size (max)	ASTM D-4751	US Sieve (max)	30	70	70	80	80
Apparent Opening Size (min)	ASTM D-4751	US Sieve (min)	80	80	80	100	100
Water Flow Rate	ASTM D-4491	GAL/MIN/	8	120	85	75	75
UV Resistance	ASTM D-4355	% (500 HRS)	80	70	70	70	70

Woven / Nonwoven			Woven	Nonwoven	Nonwoven	Nonwoven	Nonwoven
---------------------	--	--	-------	----------	----------	----------	----------

12-03 DETOURS AND BARRICADES:

- A. After coordinating and discussing plans with the Project Manager and Inspector the Contractor shall submit one (1) copy of a Traffic Control Plan, together with the Temporary Traffic Control Permit two (2) weeks prior to closing any street or causing any obstruction to traffic on any street to the Department of Public Works and Transportation. The Contractor shall not proceed with the implementation of the Traffic Control Plan until notified by the City that the plan has been accepted. The Traffic Control Plan shall be drawn at a scale not less than 1"=200' unless approved by the Traffic Engineer; and such that it is legible; and shall include proposed street closings, detours, barricade placements, and sign placement, including advance warning signs, temporary signals, portable message boards and pavement markings, if necessary. (Rev. 9/2021)

- B. The Contractor shall furnish and erect suitable barricades, signs, signals and appropriate pavement markings to protect motorists and pedestrians, as set forth in the latest edition of the TEXAS MANUAL ON UNIFORM TRAFFIC CONTROL DEVICES. However, vertical panels will not be allowed unless approved by the Traffic Engineer. The barricades, signs, signals and pavement markings shall be constructed, placed, and adequately maintained as set forth in the Traffic Control Plan or as directed by the City.

- C. Unless otherwise approved by the City two-way traffic shall be maintained on all roadways under construction at all times. If it becomes necessary to detour traffic off the existing paved roadway for more than seven (7) days, a hard surface driving lane, such as asphalt, shall be properly constructed and maintained by the Contractor throughout the duration of the detour. All temporary tie-ins shall be constructed to a minimum of 4-inches Type "B" asphalt over a compacted subgrade (standard compaction). Subsequent maintenance of all detours and tie-ins shall be considered subsidiary to the unit prices bid for temporary asphalt. Cutting, removing, and replacing the asphalt for utility installations, excavation, and/or liming operations shall be considered subsidiary to the initial placement of asphalt and will not be paid for each re-installation. Asphalt shall be replaced within seven (7) days of removal for these activities. A bid item is included for furnishing, installing, maintaining and final removal of the asphalt.

- D. Where pavement drop-offs occur, traffic control plans shall be in accordance as illustrated on the following "Traffic Control Device Detail," which is enclosed as part of these specifications. These guidelines are applicable to construction work where continuous pavement edges or drop-offs exist parallel and adjacent to a lane used for traffic.

- E. When performing maintenance on major arterials or as directed by the Traffic Engineer, Contractor shall use portable message boards to inform the public of the construction date, length of project, and to expect delays. The signs shall be operational twenty-four (24) hours a day. Portable message boards shall be erected at minimum three (3) calendar days

prior to beginning work or as directed by the City, and all verbiage shall be approved by the City Traffic Engineer.

- F. No direct compensation (unless bid item included) will be made to the Contractor for furnishing, installing, and maintaining any Traffic Control Devices, including but not limited to message boards, barricades, warning signs, signals, pavement markings, and detours and their subsequent maintenance and removal. This is to be considered subsidiary to the several items for which unit prices are requested in the PROPOSAL.
- G. Should it be necessary for the City to provide and/or maintain signs, barricades, signals, and markings due to Contractors lack of response to correct deficiencies, Contractor shall be billed for the work performed by the City.

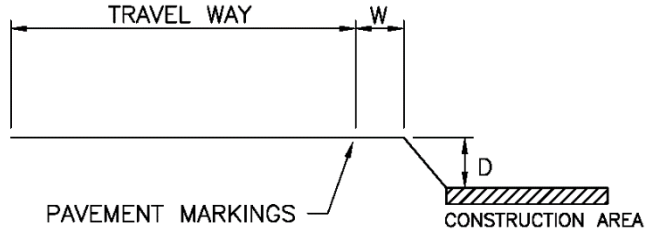

"W" GREATER THAN OR EQUAL TO 30' NO DEVICE NEEDED

"W" LESS THAN 30' BUT GREATER THAN OR EQUAL TO 12' WITHOUT CURB OR 2' WITH CURB

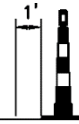

"W" LESS 12' WITHOUT CURB OR 2' WITH CURB AND:

Ⓐ "D" = 2" TO 6"



Ⓑ "D" GREATER THAN 6" TO 24"

4' MIN. (6' DESIRED)



Ⓒ "D" GREATER THAN 24"

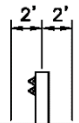

MBGF, CONCRETE MEDIAN BARRIER OR "W" SECTION ON DRUMS FOR SLOPES STEEPER THAN 2:1 (IF SLOPE IS 2:1 OR FLATTER DETAIL B MAY BE USED)

TRAFFIC CONTROL DEVICE DETAIL

ALL TRAFFIC CONTROL SHALL COMPLY WITH THE LATEST EDITION OF THE TEXAS MANUAL OF UNIFORM TRAFFIC CONTROL DEVICES

REV: 03/31/16

 CITY OF ARLINGTON, TEXAS		
Traffic Control Device		
DATE:	SCALE: NTS	SHEET: OF
DRAWN BY:	CHECKED BY:	DATE:

12-04 TEMPORARY TRAFFIC SIGNALS:

A. DESCRIPTION: Traffic signals at signalized intersections are required to remain operational at all times throughout the duration of the project. Temporary traffic signals shall be considered for all existing signalized intersections within the limits of this project. This section describes furnishing, installing, maintaining, and removing intersection temporary traffic signals. Temporary traffic signals are considered a part of the Traffic Control Plan and no additional pay will be made to the Contractor for this work.

B. GENERAL:

1. Contractor shall furnish, install, maintain, reconfigure, and remove temporary traffic signals in accordance with the latest TxDOT Standard Specifications. All traffic signals shall conform to the latest Texas Manual on Uniform Traffic Control Devices (TMUTCD)
2. Contractor shall provide temporary striping to compliment the temporary traffic signals. The temporary striping plans shall be part of the Traffic Control Plans submitted for approval.
3. City will supply signal controller cabinet and signal controller. Contractor shall contact the Traffic Operations Division to arrange for pickup of equipment.
4. Contractor shall furnish and install a temporary VIVDS system for the temporary signal. Contractor will be responsible for providing all materials necessary to make it operational.
5. The Contractor is responsible for providing connection between the temporary signal and the City's Signal Network. The Contractor shall coordinate with the City to facilitate the connection by providing three (3) business days notice to the Inspector prior to making the connection.
6. Contractor will be responsible for furnishing and installing the temporary electrical service for temporary traffic signals according to the requirements of the City. Contractor will also be responsible for all necessary permits, inspection, and coordination as needed between the City and the utility regarding billing.
7. A signal inspection of the completed temporary traffic signal installation will be performed by the City. Contractor shall provide three (3) business days notice to the Inspector to request for an inspection. The City will not approve activation until the Contractor corrects all discrepancies identified in the inspection.
8. Contractor will be responsible to verify the span heights throughout the project duration.
9. Signal faces shall be placed as directed by the City. Make every effort to give maximum visibility to all signals intended for view by the motoring public.

10. The name and telephone number of the persons qualified and assigned to maintain the temporary traffic signal shall be provided to the City. Ensure this personnel will be available twenty-four (24) hours a day, seven (7) days a week, from the start of the project until the temporary traffic signal is no longer needed. Emergency calls must be received by an individual and not by an answering machine.
11. Upon completion of new signal installation, the Contractor shall switch control of the intersection over to the new permanent cabinet. Upon deactivation of the temporary signal, Contractor will need to call the electrical utility immediately for disconnection of the temporary electrical service.
12. Upon acceptance of new signal, completely remove poles and other supports used for temporary signals. Remove the temporary traffic signal faces the same day the permanent traffic signal is turned on. Removal of remaining temporary signal components shall be completed within three (3) days of activation of the permanent signal. With approval, concrete foundations may be left 2-feet or more below finish grade. Backfill and surface restoration is the responsibility of the Contractor.
13. Any equipment furnished by the city shall be returned to the city, unless the city desires to use the equipment in the permanent signal system. All other temporary signal components shall be completely removed and retained by the Contractor.

C. MAINTENANCE:

1. Contractor shall immediately correct lamp/LED outages within twenty-four (24) hours of the reported outage.
2. Contractor shall respond within one (1) hour of notification to provide corrective action to any emergency such as but not limited to signal cable problems and equipment failures. If equipment becomes damaged or faulty beyond repair, replace it within one (1) working day. It will be the Contractor's responsibility to ensure sufficient amounts of materials and equipment are in stock to provide immediate repairs.
3. The City of Arlington Field Operations Division will make every effort to have permanent signals relocated, in place, and in working order as required by the time the project is accepted. If this does not occur, it will not delay project acceptance; and a separate agreement between the general Contractor, subcontractor, and the City may be written so the City takes over responsibility of payments to the traffic control subcontractor for on-going maintenance and removal of the temporary signals.

12-05 PROTECTION OF THE PUBLIC:

- A. The Contractor shall at all times conduct the work in such manner as to ensure the least possible obstruction to public traffic and protect the safety of the public. Any provisions necessary for the work being performed to provide public safety and convenience shall be the direct responsibility of the Contractor and shall be performed at his/her expense.

- B. Materials placed on the site, materials excavated and construction materials or equipment shall be located so as to cause as little obstruction to the public as possible.
- C. The City reserves the right to remedy any neglect on the part of the Contractor in regard to public convenience and safety which may come to our attention. The cost of such work done or material furnished by the City shall be billed to the Contractor.

12-06 PROTECTION OF FLOODPLAIN:

- A. No dumping will be allowed in floodplains or below the 100-year flood elevation of drainage ways. Areas in the floodplain or near drainage ways shall be protected and be undisturbed unless otherwise noted in the construction plans. No items shall be placed in the floodplain or drainage ways unless approved by the City, including but not limited to temporary stockpiling and/or material storage.
- B. Contractor is responsible for ensuring all applicable local, state and federal permits are approved prior to any land disturbance in floodplains or drainage ways. Construction activity shall not divert or obstruct the natural flow of surface water in a manner that damages surrounding properties.

12-07 PROTECTION OF ADJACENT PROPERTY:

- A. The Contractor shall be responsible for the protection of all fences, trees, curb and gutter, and other improvements on the property adjoining the construction sites from damage by the Contractor's equipment and personnel. The Contractor shall be responsible for notifying the property owners in advance of any trimming to be done on trees. The Contractor will notify the City of any trees, shrubs, or bushes that are not identified on the plans that must be removed by the construction. Trees not identified on the plans shall not be removed until permission is granted by the City. The Contractor will not be allowed to place excess material, forms, equipment, or any other material outside the street right-of-way without written permission of the property owner and approval of the City.
- B. For documentation purposes, the Contractor will be responsible to video the job site prior to commencing work and to provide the Inspector with a date stamped copy of the video. To avoid any dispute of damages caused, it is strongly recommended the video be of good quality and capture as much detail as possible. Contractor will be responsible for any damages caused by the Contractor or his/her subcontractors. Damages shall be repaired or resolved promptly upon notification by the Inspector. Damages to irrigation by negligence of the Contractor shall be repaired by a licensed irrigator within forty-eight (48) hours of being damaged. Contractor will be responsible for any cost incurred if City forces or City's contractor repairs the damages due to lack of response from the Contractor. Such cost shall be billed to the Contractor.

12-08 PROTECTION OF ADJACENT LANDSCAPING IMPROVEMENTS:

- A. The Contractor shall be responsible for the protection of any existing landscaping improvements in the medians and parkways adjacent to the project including but not limited to trees, shrubs and irrigation from damage by Contractor's equipment or personnel.

- B. If the Contractor damages any of the landscaping improvements, the Contractor shall be responsible for replacing and/or repairing the improvements at his/her expense. Monthly pay estimates may be withheld until the replacement or repair has been fully performed. If the Contractor feels any of the landscaping improvements are in conflict with the project and must be removed or have prior damage, the Contractor shall notify the City prior to removal of any landscaping improvements.

12-09 PROTECTION & CLEANING OF EXISTING STORM OR SANITARY SEWERS:

- A. If the Contractor, through carelessness or negligence, obstructs the flow of or deposits any materials into any existing storm or sanitary sewer lines, the Contractor shall provide the necessary equipment and labor (or hire a subcontractor approved by the City) to clean and televise the affected lines. The limits of the lines to be cleaned and televised will be determined by the Inspector.
- B. The identified lines shall be cleaned within forty-eight (48) hours of notification. In emergency situations, timeline for cleaning the lines will be determined by the Inspector. After cleaning, the Contractor shall televise and videotape the lines. Video tapes shall be delivered to the Inspector so they can be reviewed and approved for acceptance of the cleaning work.

12-10 MAINTENANCE OF ADEQUATE DRAINAGE: Contractor shall maintain adequate drainage at all times during construction. Changing of natural runoff flow locations or concentrating flows to a point of potential harm to the adjacent property will not be allowed.

12-11 TEMPORARY ACCESS TO PRIVATE PROPERTIES:

- A. The Contractor shall maintain all private drives in an accessible condition to allow residents ingress and egress before leaving the job site, except during the placing and curing of drive approaches. All commercial drives and other locations with high traffic volumes, as directed by the City, shall be a minimum of 4-inches Type “B” asphalt over a compacted subgrade (standard compaction). Subsequent maintenance of drives shall be considered subsidiary to the unit prices bid. Cutting, removing, and replacing the asphalt for utility installations, excavation, and/or liming operations shall be considered subsidiary to the initial placement of asphalt and will not be paid for each re-installation. Asphalt shall be replaced within seven (7) days of removal for these activities.
- B. Should a vehicle become damaged or stranded due to an inaccessible condition, any legitimate claims arising from such conditions shall be the sole responsibility of the Contractor. The City reserves the right to withhold monthly pay estimates until all claims are resolved.

12-12 CRUSHED STONE BAD WEATHER PROTECTION:

- A. During periods of bad weather, the Contractor shall put in place, on excavated streets, 1½-inches to 2-inches crushed stone or crushed concrete sufficient to provide temporary access to private property. All material will be removed and stockpiled for future use at other locations as necessary. Any material removed and hauled off the project site without

approval from the City will be replaced by an equal quantity at the Contractor's expense. Special care will be taken by the Contractor during placement and removal of the material, not to unnecessarily combine it with native material on the project. If special care is not taken by the Contractor, an equal quantity of material will be replaced at the Contractor's expense.

- B. Weight tickets shall be submitted to the Inspector or his/her representative no later than one (1) week after delivery. Any tickets not submitted within this time frame or signed by the Inspector shall not be paid.
- C. NOTE: The use of crushed stone or crushed concrete as a means to detour traffic or maintain two-way traffic will not be paid under this item.
- D. The tons in the bid quantity are rough estimates. The actual amount used will be determined by the need for temporary and/or emergency access during construction.

12-13 USE OF PRIVATE PROPERTY:

- A. The Contractor shall not at any time use private property to park or turn around construction vehicles or store equipment and/or materials without the written permission of the property owner.
- B. The Contractor shall not at any time use water metered by meters set for the property owner's use without written permission of the property owner. Contractor is responsible for any and all damages caused to private property or additional cost incurred by property owner due to use of property for construction purposes.

12-14 USE OF CITY PARKS:

- A. The Contractor shall obtain written permission from the Parks and Recreation Department prior to the use of City park property for access or for the storage of machinery, equipment, materials, and/or supplies.
- B. Any damage incurred to City park property, by unauthorized use by the Contractor will be the responsibility of the Contractor to repair in an equal or better condition. Monthly pay estimates to the Contractor may be withheld until the damage is repaired and/or payment for the damages has been made.

12-15 CONSECUTIVE STREET CONSTRUCTION: The rate of progress shall be such that at no time shall more than three (3) streets be under construction at the same time without prior approval by the City.

12-16 TOWING OF VEHICLES: The Contractor shall follow applicable City Ordinances should it be determined that vehicles parked upon a City street must be moved in order to perform street maintenance or construction. Contractor shall provide ample notice to the City if any vehicle is to be towed.

12-17 CONSTRUCTION WATER:

- A. Contractor is responsible to provide all water necessary for the construction of this project. All construction water will be metered by City owned meters. A fee and a deposit must be paid before the meter is released to the Contractor. Payment and meter pick up locations are the South Service Center, 1100 S.W. Green Oaks, or City Hall Customer Care, 101 W. Abram. The meter readings will be submitted online by the Contractor and billed each month in accordance with the current Customer Care and Business Services Policy.
- B. Any damage that occurs to the meter during this time will be repaired by the City at the expense of the Contractor. The cost of the repairs will be deducted from the deposit and the remaining deposit will be returned to the Contractor. This procedure will be followed wherever construction water is needed.
- C. If the meter is set on a fire hydrant, the meter assembly shall be provided with an approved backflow prevention device, provided by the Contractor in accordance with the standard detail and the Fire Hydrant Meter Agreement requirements located under <http://www.arlingtontx.gov/details>.

(Rev 4/2019)

12-18 DAILY CLEANUP & REMOVAL ITEMS:

- A. The removal of existing concrete curb and gutters, concrete valley gutters, concrete drive, and existing drainage features, shall be at the locations indicated by the City and shall be paid for under the right-of-way preparation pay item (See Special Provision Section 12-22, Right-of-way/Easement Preparation) unless a separate bid item is included in the PROPOSAL.
- B. All concrete curb and gutter and drive approaches removed will be broken out at existing construction expansion joints if possible. Where existing concrete is removed, the slab will be sawed in a neat straight line the full depth of the slab. The cost for sawing and breaking shall be considered subsidiary to the unit price bid for concrete removal. The Contractor shall make every effort to protect all concrete surfaces that will remain. Any remaining surfaces damaged during removal operations by the Contractor will be replaced at the Contractor's expense.
- C. Disposal of excess materials and debris resulting from construction, including but not limited to concrete, excess soil, forms, and rebar shall be removed and disposed of on a daily basis, unless other disposal schedule is approved by Inspector. Depending on type of material or debris, dump trucks should be the primary source of disposal. Contractor will be responsible for providing the necessary equipment or vehicle for such task.
- D. Dump trucks must be tarped while in transit to disposal sites. Tarps must be secured and not torn or tattered. All applicable State and local laws and ordinances relating to hauling, handling, and disposal of such materials shall be complied with. Use of Roll Off Box shall meet the City's Ordinances.

- E. The responsibility of locating suitable disposal sites for removal items on this project will be solely a function of the Contractor. The City will in no way be responsible for the actions of the Contractor if he disposes of excess material in locations that are not approved.

12-19 DUST CONTROL: Contractor will be responsible for minimizing dust on a daily basis and when instructed by the City. Dust control shall include, but is not limited to operations such as watering stockpiles, subgrade, pavement, sawing (including brick pavers), concrete joint sealing, routing, and crack sealing. Equipment necessary for capturing particulate matter during the process of routing, cleaning & sealing cracks & joints shall be considered subsidiary. The necessary application of water for dust shall be considered subsidiary to the other bid items.

(Rev. 10/2020)

12-20 MOWING DURING CONSTRUCTION: Contractor shall maintain existing parkways and medians at all times during construction by providing periodic mowing to meet the applicable City Ordinances. Any code violation or citation issued for not maintaining these areas will be the responsibility of the Contractor. Contractor will also be responsible for any cost incurred if City forces or City's contractor performs the mowing due to lack of response from the Contractor. Such cost will be billed to the Contractor.

12-21 EXISTING UTILITIES:

- A. In the preparation of plans and specifications, the engineer has endeavored to indicate the location of existing underground utility lines which are known to the engineer. It is not guaranteed that all lines or structures have been shown on the plans. Prior to the start of construction, the Contractor shall communicate with the local representative of all utility companies and advise said representatives of the route of the proposed construction in order to obtain the assistance of the utility companies in the location of and in the avoidance of the conflicts with utility lines.
- B. The Contractor should not assume the City has Surface Utility Engineering (SUE) maps for any of the proposed locations. Contractor will be responsible for calling for ALL locates (1-800-DIGTESS) in a timely matter to ensure utility issues are addressed and resolved within the allotted contract time. Contractor will also be responsible for complying with all State regulation and requirements.
- C. For the City's Streetlights, Storm Water, Signals, Fiber Optics, Water and Sewer line locates, request must be made online through the City's web site or through the "Ask Arlington" App. For emergency locates, as defined as a situation that endangers life, health, or property; or a situation in which the public need for uninterrupted service and immediate re-establishment of service, or if services are interrupted compels immediate action, call (817) 459-5900. If a request is falsely called in as an emergency, Contractor will be liable for payment of the emergency line locate service call.
- D. The Contractor shall contact the proper utility representative for questions or coordination of construction related to existing utilities. It is the Contractor's responsibility to uncover and determine the elevation and location of all potential conflicts well ahead of the excavation.

- E. The Contractor shall make every effort to protect existing utilities and other lines or structures. The Contractor shall not adjust, remove, or operate existing utilities unless specifically requested to do so in these specifications or authorized to do so by the City.
- F. Contractor shall protect all utility pole(s) impacted by the construction. Protection shall include temporary bracing of the utility poles where adjacent excavation could reasonably compromise the stability of the utility pole(s). Contractor shall coordinate the utility pole bracing with the owner of the utility pole(s) and the City. Unless there is a specific pay item for temporary pole bracing of utility pole(s), bracing of utility poles shall be incidental to other pay items included in the contract. Any utility damaged by the Contractor during the construction shall be suitably replaced at the Contractor's expense.
- G. Where excavation endangers adjacent structures and utilities, the Contractor shall, at his/her own expense, carefully support and protect such structures and/or utilities so that there will be no failure or settlement. Where it is necessary to move services, poles, guy wires, pipe lines, or other obstructions, the Contractor shall notify and cooperate with the utility owner.
- H. Should damage to any existing structure or utility occurs, whether from failure or settlement, the Contractor shall restore the structure or utility to its original condition and position without compensation from the City. All costs of temporarily or permanently relocating the conflicting utilities shall be borne by the Contractor without extra compensation from the City.

12-22 SITE PREPARATION: N//A

12-23 TREE REMOVAL:

- A. All trees to be removed shall be tagged and approved by the City prior to removal. (Rev. 7/2021)
- B. All trees and bushes that are cut down shall be hauled off the same day. (Rev. 7/2021)
- C. Contractor will fully comply with any and all federal, State and local laws related to the removal of trees including but not limited to the Migratory Bird Treaty Act. Contractor will be responsible for any fines, penalties, or damages due to any such violations of law and any such fines, penalties, or damages will be subject to the indemnification provision of this contract.

12-24 TREE TRIMMING:

- A. All trees shall be trimmed back to avoid damage by construction equipment. All cuts shall be clean and smooth, with the bark intact with no rough edges or tears. Tree trimming shall be done in accordance with the International Society of Arborists or National Association of Arborists Standards. Trees shall also be protected to avoid damage by construction activities. (Rev 1/2019)

B. Prior to initial acceptance of the project, Contractor shall trim the lower branches of all trees that overhang the sidewalk to a minimum height of 7-feet above the sidewalk.

(Rev 1/2019)

C. Payment for tree trimming and protection is considered subsidiary to the contract unless a separate pay item has been included in the Proposal.

(Rev 1/2019)

12-25 SITE GRADING: N/A

12-26 BORROW: N/A

12-27 FILLING: N/A

12-28 SELECT FILL: N/A

12-29 SPRINKLER RELOCATIONS:

A. Sprinkler relocations may be required on this project. The City will be responsible for sprinkler relocations. Prior to construction, the Contractor and Inspector shall identify and document the sprinkler systems that will be affected by the construction of the project. The Contractor shall contact the owner of each sprinkler system and arrange to test each system. In the presence of the Inspector, the Contractor shall:

1. determine if the system functions properly
2. identify the layout of the system and
3. document in writing the layout and function of the system. The work described above is required by the Contractor for all projects and should be considered subsidiary to the unit prices bid for other items.

B. When construction activity approaches a sprinkler system, the Contractor shall provide the Inspector seven (7) days notice to allow for relocation of the sprinkler system. Should the Contractor damage any sprinkler system, it will be the Contractor's responsibility to repair or replace the same at no additional charge to the City.

12-30 CRUSHED STONE CUSHION:

A. When in the opinion of the City the subgrade material encountered at grade is soft spongy, and unsuitable, it shall be removed to a depth necessary below the barrel of the pipe to achieve stable layers and replaced with a crushed stone cushion so as to provide an unyielding stable foundation. The stone used in cushion shall be 1-inch washed crushed stone and shall be free from silt, loam, or vegetable matter and shall be of a gradation of from ¾-inch to 1-inch.

B. Crushed stone cushion will be paid for at the contract unit price per ton in place and shall be the total compensation for furnishing all labor, materials, tools, and equipment for

performing this particular phase of work. Crushed stone cushion shall be paid for the amount of stone placed at a depth greater than 6-inches below the bottom of the pipe.

- C. Subgrades that have been allowed to become unstable by neglect or fault of the Contractor, by improper drainage or lack of drainage, the City shall order the Contractor to remove the unstable subgrade and replace the same with crushed stone cushion at the expense of the Contractor.

12-31 BACKFILL & BACKFILL MATERIAL:

- A. Backfill operations shall begin immediately following removal of the forms on the permanent improvements. All loose concrete, rocks, roots, trash, and other debris shall be removed from the excavation prior to any backfill being placed.
- B. Backfill material shall consist of the native material obtained from excavation unless in the opinion of the City, this material is unsuitable for use. The material shall not contain trash, rocks, concrete, asphalt, gravel, roots, or other debris. Sand shall not be used for backfill material unless the native soil in the construction area is sandy in nature. All backfill material will be considered subsidiary.

12-32 MECHANICALLY COMPACTED BACKFILL:

- A. Areas shall be backfilled with native material and compacted by mechanical methods. Compaction must be achieved with equipment specifically designed for compaction only. If hand pneumatic tampers are used, the backfill shall be placed in layers not exceeding 6-inches in loose thickness and thoroughly compacted to at least ninety-five percent (95%) density per ASTM D698, +/- two percent (2%) optimum moisture content.
- B. Backfill shall be placed in uniform layers completely across the area, and compaction shall proceed in an orderly, uniform manner. If compaction is performed by the use of heavy tamping (sheep's foot) rollers, backfill shall be placed in layers not exceeding 9-inches in loose thickness and compacted to at least ninety-five percent (95%) density per ASTM D698, +/- two percent (2%) optimum moisture content. The use of walk behind and remote compacting rollers will not be permitted.
- C. Payment for backfill shall be subsidiary to unit prices bid for pipe.

12-33 TRENCHLESS TECHNOLOGY: This specification is for general application only and not for pipe bursting or other trenchless rehabilitation methods.

- A. Prior to construction, all existing public facilities shall be physically located in the field when crossing over or under water lines, sanitary sewer, or storm drains or where the existing facility is running in the same direction and is within 5-feet of the proposed facility.
- B. Construction shall be done in such a manner that will minimize interference with vehicular traffic and shall not weaken or damage the existing street.

1. The location of the boring pits shall be a minimum of 5-feet from the roadway to prevent undermining of the curb, gutter, or shoulder section.
 2. The pit shall be dug to a depth sufficient to maintain a minimum boring depth of 48-inches below the traffic surface. Jetting types of boring equipment are not allowed.
 3. All overcutting shall be remedied by pressure grouting the entire length of the installation.
 4. The pits or trenches excavated to facilitate this operation shall be backfilled and compacted immediately after work is completed.
- C. The Contractor shall be able to locate the bore head at all times in accordance with the latest technologies and provide the location of the bore to the City upon request.
- D. All directional boring shall have the locator place bore marks and depths while the bore is in progress. Locator shall place a mark at each stem with a paint dot and indicate the depth at every other stem.

12-34 BACKFILL AND CLEANUP:

- A. Backfill and cleanup shall be done daily. This work shall progress immediately behind pipe laying and shall be within 50-feet of the pipe laying operation at all times. It shall also include the disposal of all excess material on a daily basis. Ditch lines, storm drains, inlets, bar ditches, and other drainage facilities shall be maintained and cleaned on a daily basis so they will function for their intended purposes.
- B. Where lines or services are laid in, along, or across the street pavement, the ditch line shall be backfilled and an approved all weather surface, such as flexbase or CTB shall be installed upon the completion of that day's work. Approved barricades shall be erected at these locations and shall be maintained by the Contractor until the permanent pavement is replaced. No later than the second day following the installation of a line, the specified asphalt shall be placed in the ditch and the street repair shall be completed. In the event these procedures are not followed, pipe laying shall cease immediately and not resume until the cleanup is completed and the roadway is safe for traffic.
- C. Particular care shall be taken during inclement weather to ensure that driveways are backfilled with an approved all weather surface. No driveway shall be blocked for longer than two (2) hours and only after notifying the affected property owner.
- D. All curbs and sidewalks shall be backfilled as soon as possible. If "honeycomb" appears, the Contractor shall grout back side to smooth out the surface within twenty-four (24) hours of form removal.
- E. Where lines or services are laid in, along, or across street pavement the pavement shall be left in a clean and acceptable condition. At the end of each work day the Contractor shall sweep and/or wash the pavement to leave the roadway completely clean of dirt and debris.

Dirt, debris, and/or wash water shall be collected for appropriate disposal and shall NOT be washed into waterways or storm drains. Other suitable methods of maintaining the pavement in a clean, unobstructed condition may be utilized by the Contractor. No additional payment will be made for cleaning of pavement. It shall be considered subsidiary to the work performed under this contract.

12-35 FLOWABLE BACKFILL: Use of flowable backfill shall be preapproved by the City prior to application.

A. **FLOWABLE BACKFILL:**

1. Flowable backfill shall consist of a mixture of native sand or a blend of native sand/manufactured sand, cement, fly ash and water which produces a material with unconfined compressive strength of between two hundred fifty (250) and four hundred fifty (450) psi after twenty-eight (28) days.
2. The flowable mixture shall be mixed at a concrete batch plant or a mobile transit mixer and shall have a minimum slump of 5-inches. Unless otherwise allowed by the City, the flowable mixture must be allowed to set at a minimum of forty-eight (48) hours prior to the placement of any overlying material.

B. **MODIFIED FLOWABLE BACKFILL:**

1. Modified flowable backfill in areas of possible future excavation such as utility installations shall consist of a mixture of native sand or a blend of native sand/manufactured sand, cement, fly ash and water which produces a material with unconfined compressive strength of between fifty (50) and one hundred fifty (150) psi after twenty-eight (28) days.
2. Modified flowable backfill in permanent areas such as abandoned pipe closures, abutments and embankments shall contain the same materials with an unconfined compressive strength of greater than one hundred fifty (150) psi after twenty-eight (28) days.
3. The flowable mixture shall be mixed at a concrete batch plant or a mobile transit mixer and shall have a minimum slump of 5-inches.
4. Unless otherwise allowed by the City, the flowable mixture must be allowed to set at a minimum of forty-eight (48) hours prior to the placement of any overlying material.
5. The Contractor shall submit to the City a mix design for the type of flowable backfill to be used ten (10) days prior to the start of the backfill operation. When the mix design has been approved by the City there shall be no changes or deviation from the proportions or sources of supply except as approved by the City.

12-36 TEMPORARY STREET REPAIR:

- A. A temporary driving surface will be required on all street cut openings. It shall be composed of permanent type paving material, specifically excluding gravel or flexbase as the surface material, unless approved by the City.
- B. A minimum of 4-inches hot mix asphaltic concrete (Type “D”) over a minimum of 6-inches flexbase on compacted native material shall be used for all streets regardless of classification. (Rev. 9/2019)
- C. All flexbase shall be in accordance with the latest TxDOT Standard Specifications and shall be Type “A” Grade 1 material. An acceptable alternative to Type “A” Grade 1 flexbase is crushed concrete. Crushed Concrete shall be categorized as Type “D” Grade 1 Flexbase. Flexbase shall be thoroughly compacted and placed to a depth specified on the City’s detail and shall be subsidiary to the temporary street repair items.
- D. Installation of temporary street repairs will be completed by the Contractor as soon as possible after completing the backfill, but always within five (5) business days after completion of the work involving the cut.
- E. Road plates may not be used for more than five (5) business days. Any temporary driving surface that fails to provide an acceptable driving surface shall be removed and replaced at the Contractor’s expense, as directed by the Inspector.

12-37 VERTICAL ADJUSTMENT OF WATER VALVES, MANHOLES, ACCESS CHAMBERS AND CLEANOUTS:

- A. Contractor shall identify, verify, and mark locations of all water valves, manholes, access chambers, and cleanouts. It is the Contractor’s responsibility to maintain their functionality at all times during construction. Any damage through carelessness or negligence will be the contractor’s responsibility to repair or replace the same at no additional charge to the City.
- B. For concrete pavement, all water valves, manholes, access chambers, and cleanouts shall be brought to the final grade before placement of concrete. Valve boxes shall be adjusted to the final grade by adjustment of the screw type valve box.
- C. For asphalt pavement reclamation, all new water valves, manholes, access chambers, and cleanouts shall be adjusted to approximately 1-foot below the bottom of the proposed subgrade prior to the application of cement or lime slurry. Adjustment to the final grade and installation of the concrete pad per details shall be made after placement of the top layer of surface course. The valve boxes shall be adjusted to the final grade by adjustment of the screw type valve box.
- D. For asphalt pavement mill & overlay, ductile iron valve box extension for valve box and grade ring for manholes and access chamber may be used for adjustment to the final grade.
- E. The existing lids for water valves, manholes, access chambers, and cleanouts may be reused if instructed by the City. All grade rings, frames and covers, and cones (if cone

replacement is instructed by the City) for adjustments shall be furnished and installed by the contractor and subsidiary to other unit prices bid in the PROPOSAL. (Rev. 2/2021)

- F. This paragraph is only applicable to the City's Asphalt Pavement Maintenance Projects. All the ductile iron valve box extensions, grade rings, frames and covers for adjustments will be furnished by the City. Contractor shall provide a minimum of two (2) weeks notice to the Inspector prior to picking up from the South Service Center Warehouse, 1100 SW Green Oaks Boulevard, and transporting to the job site. Any damage to the materials once they leave the warehouse will be the contractor's responsibility to replace the same at no additional charge to the City. The valve boxes shall be adjusted to the final grade by adjustment of the screw type valve box.

12-38 GREEN CEMENT:

- A. In striving to improve air quality in the North Texas area, an alternate bid item to add the additional cost of "green" cement above the cost of cement supplied from an unspecified source will be considered as part of this project. Utilization of "green" cement will be considered for raw cement and for items where concrete is placed or cast-in-place (examples: pavement, driveways, cement for stabilization, sidewalk, barrier free ramps, curb inlets, curb and gutter, flumes, and channel lining).
- B. "GREEN" cement is defined as cement that is generated from a kiln whose emission rates:
1. Are in compliance with all applicable state and federal environmental standards relating to the emission of NO_x, including all applicable TCEQ and EPA rules and regulations; and
 2. Operate kilns that exceed the standards for NO_x emissions set out in 30 Tex. Admin. Code § 117.3110(a)(1)-(4) (as provided presently and as may be amended in the future) by the following percentage amounts:
 - a. For each long wet kiln, ten percent (10%) lower than the standard for long wet kilns located in Ellis County, Texas as set out in 30 Tex. Admin. Code § 117.3110(a)(1)(B);
 - b. For each long dry kiln, twenty percent (20%) lower than the standard for long dry kilns, as set out in 30 Tex. Admin. Code § 117.3110(a)(2);
 - c. For each preheater kiln, twenty percent (20%) lower than the standard for preheater kilns, as set out in 30 Tex. Admin. Code § 117.3110(a)(3); and
 - d. For each preheater-precalciner kiln or precalciner kiln, thirty-five percent (35%) lower than the standard for preheater-precalciner or precalciner kilns, as set out in 30 Tex. Admin. Code § 117.3110(a)(4).
- C. Should the City award the contract with this alternate, the Contractor and the material supplier will need to sign a certified compliance statement. Form will be provided by the City. No payment on the alternate item for utilizing "green" cement will be made unless this statement is executed and returned to the City.

12-39 REINFORCING STEEL:

- A. All reinforcing steel used on this project shall comply in all respects to TxDOT Item 440, "Reinforcing Steel".
- B. Rebar that requires bending in the field shall be Grade 40 reinforcing steel. Payment for reinforcing steel shall be considered subsidiary to the various bid items.

12-40 RESTORATION OF EXISTING PAVED SURFACES:

- A. The Contractor shall be responsible for maintenance of existing paved roadway surfaces within the project limits throughout the duration of the project. The Contractor shall perform daily inspections and restoration work required to provide an acceptable driving surface, as determined by the City.
- B. Restoration of paved surfaces shall be of asphalt, unless otherwise approved by the City. Should the Contractor be notified of unacceptable roadway conditions, the Contractor shall restore the surface within twenty-four (24) hours. Should it become necessary for the City to provide for the restoration of the surface, the cost of such will be billed to the Contractor. All asphalt for restoration of existing paved surfaces shall be considered subsidiary to the various bid items on this contract.

12-41 GALVANIZED GABIONS WITH PVC COATING: N/A

12-42 CONDUIT: N/A

A.

12-43 SLOPE EROSION CONTROL: N/A

12-44 TOPSOIL:

- A. A minimum of 4-inches of topsoil shall be placed on all disturbed areas within and adjacent to permanent improvements within the project limits. Topsoil shall be approved by the City prior to application. The topsoil shall be free from stone, rock, lumps, clods of hard earth, plants or their roots, sticks and other foreign material and shall be brought to the lines and grades as established by the City. Under no circumstances will topsoil be accepted unless it is free from the aforementioned contaminants. (Rev. 9/2019)
- B. Contractor may use approved means of treating the topsoil to ensure its acceptability. This item shall be considered subsidiary to the other items in this project and shall not be a separate pay item.
- C. The existing topsoil from the project limits may be used if Contractor stockpiles and protects it properly. No trash, lime shavings or other foreign material, shall be added to this stockpile. All topsoil including existing topsoil that is stockpiled shall meet the following specification:
- D. The soil texture shall be classified as loam or sandy loam according to the following criteria:

	(% Passing) <u>Loam</u>	(% Passing) <u>Sandy Loam</u>
Sand (0.074 to 4.76 mm diameter)	25-50%	45-85%
Silt (0.002 to 0.074 mm diameter)	30-50%	Less than 50%
Clay (Smaller than 0.002 mm) (Hydrometer analysis)	5-25%	Less than 20%

Soil texture shall be determined by utilizing processes as prescribed in ASTM D 422.

- E. Topsoil material shall be stockpiled at locations approved by the City. After completion of the permanent improvements, topsoil shall be placed on all disturbed areas so as to provide a minimum 4-inches depth of topsoil. Clumps shall be reduced to less than 1-inch diameter.

12-45 HYDRO-MULCH SEEDING:

- A. DESCRIPTION: This item shall consist of preparing ground, providing, and planting seed, or a mixture of seeds, of the kind specified along and across such areas as are designated by the City.
- B. MATERIALS: The type seed used shall be in accordance with COG Specification, Section 202.6, and approved by the City. All seed must carry a Texas Seed Label showing purity and germination, name and type of seed, and that it meets all requirements of the Texas Seed Law. Seed furnished shall be of the previous season's crop and the date of analysis shown on each tag shall be within nine (9) months of the time of delivery to the project. Each variety of seed shall be furnished and delivered in separate bags or containers. The City may require a sample of each variety of seed to be furnished for analysis and testing. Grass seed shall equal or exceed ninety-five percent (95%) purity and ninety percent (90%) germination.
- C. PLANTING SEASON: Planting of hulled bermuda grass seed shall be done between the months of April through September. The density of seeds planted shall be eighty (80) pounds per acre. A blend of thirty (30) pounds Rye grass and forty (40) pounds unhulled bermuda may be used between the months of September through April.
- D. CONSTRUCTION METHODS: The designated areas shall be raked, leveled and fine graded as necessary to provide a smooth uniform grade, free of ruts, depressions, humps and objectionable soil clods, prior to seeding. The area shall also be free of weeds, rubbish, and building materials. Any low areas shall also be filled to prevent ponding. All particles in the seed bed shall be reduced to less than 1-inch in diameter or they shall be removed. The areas to be seeded shall be moisture conditioned prior to placement of seed. In areas that appear to be overly compacted or to destroy existing vegetation, the soil shall be loosen or disked, at the direction of the City. The cost of any chemical treatment to the soil in order to establish a uniform stand of grass will be subsidiary to "Hydro-mulch Seeding."

Seeding of the type specified shall be performed in accordance with the requirements in COG Specification 202.6 except as hereinafter described:

1. Watering: The seeded areas shall be watered as necessary to establish grass as described in Establishment and Acceptance of Seeding.
 2. Hydro-Mulch Seeding: In accordance with COG Specification 202.6.4.4 alternate methods for placement of seed may be used if approved by the City
- E. MEASUREMENT: Work and acceptable material for "Hydro-mulch Seeding" will be measured by the unit bid, complete in place.
- F. ESTABLISHMENT AND ACCEPTANCE OF SEEDING: Regardless of unseasonable climatic conditions or other adverse conditions affecting planting operations and the growth of the grass, it shall be the sole responsibility of the Contractor to establish a uniform stand of grass as herein specified. When adverse conditions such as drought, cold weather, high winds, excessive precipitation, or other factors prevail to such an extent that satisfactory results are unlikely, the City may, at his/her own discretion, stop any phase of the work until conditions change to favor the establishment of grass.
- G. MAINTENANCE: Maintenance shall begin immediately after each portion of grass area is planted. It will be the Contractor's responsibility to maintain the existing grades and leave them in a true and even condition after planting. All planted areas will be protected and maintained by watering, weed control, mowing, and replanting as necessary for at least thirty (30) days after initial planting and for as much longer as necessary to establish a uniform stand with complete coverage of the specified grass.
- H. FERTILIZER: (Subsidiary to Seeding Item)
1. Description: This item shall consist of providing and distributing fertilizer over the seeded areas.
 2. Materials: Shall be in accordance with COG Specification 202.4.1 and Section 12-46 below.
 3. Construction Methods: The fertilizer shall be pelleted or granular fertilizer and shall be applied uniformly over the entire area specified to be fertilized and in the manner directed for the particular item of work. The fertilizer shall be dry and in good physical condition. Fertilizer that is powdered or caked will be rejected. Distribution of fertilizer for the particular item of work shall meet the approval of the City.

Unless otherwise indicated on the plans, fertilizer shall be applied uniformly at the average rate of four hundred (400) pounds per acre for all types of seeding.

- I. PAYMENT:
1. The work performed and materials furnished and measured as provided under "Measurement" will be paid for at the unit price bid for "Seeding" which price shall be

full compensation for furnishing all materials and for performing all operations necessary to complete the work, including fertilizer. Once a "uniform stand of grass" is provided, the City will provide payment for the seeding. See definition of "uniform stand of grass" below.

2. Uniform Stand of Grass: A uniform stand with complete coverage of the specified grass shall be defined as not less than one hundred-fifty (150) growing plants per square foot seeded. Growing plants shall be defined as healthy grass plants of two blades or more at least 2-inches tall.

12-46 SODDING/TURFGRASS PLANTING: This work includes labor, material, and equipment for soil preparation, fertilization, planting, and other requirements regarding turfgrass planting areas. Payment for sodding shall include the cost of all fertilizer and water. Grass sod variety shall match existing and adjacent property.

A. SUBMITTALS: Samples and Producers' Specifications: Various samples, certificates, and specifications of seed, fertilizer, sand, compost, other soil amendments and other materials shall be submitted for approval as required by subsequent sections of this specification.

B. TURFGRASS:

1. Buffalograss Sod, Bermuda Sod or Saint Augustine: Turfgrass sod shall be "Buchloe dactyloides" (Buffalograss) 'Prairie Grass' variety, "Cynodon dactylon" Common Bermuda Grass, or "Stenotaphrum secundatum" Saint Augustine Grass.. Sod shall consist of stolons, leaf blades, rhizomes, and roots with a healthy, virile system of dense, thickly matted roots throughout the soil of the sod for a thickness not less than ¾-inches. Sod shall be alive, healthy, vigorous, free of insects, disease, stones, and undesirable foreign materials and grasses. The grass shall have been mowed prior to sod cutting so that the height of the grass shall not exceed 2-inches. Sod shall have been produced on growing beds of clay or clay-loam topsoil. Sod shall not be harvested or planted when its moisture condition is so excessively wet or dry that its survival will be affected. All sod is to be harvested, delivered, and planted within a thirty-six (36) hour period of time. Sod shall be protected from exposure to wind, sun and freezing. If sod is stacked, it shall be kept moist and shall be stacked roots-to-roots and grass-to-grass.
2. Dimensions: All sod shall be machine cut to uniform soil thickness of 1-inch plus or minus ¼-inch. All sod shall be of the same thickness. Rectangular sections of sod may vary in length, but all shall be of equal width and of a size that permits the sod to be lifted, handled, and rolled without breaking. Broken pads and torn, uneven ends will be unacceptable.
3. Solid Sodding: Prior to laying the sod, the planting beds shall be raked smooth to true grade and moistened to a depth of 4-inches, but not to the extent causing puddling. The sod shall be laid smoothly, tightly butted edge to edge, and with staggered joints. The sod shall be pressed firmly into contact with the sod bed by

rolling or by hand tamping with an approved tamper so as to eliminate all air pockets, provide a true and even surface, and insure knitting without displacement of the sod or deformation of the surfaces of sodded areas. Following compaction, fine screened soil of good quality shall be used to fill all cracks between sods. Excess soil shall be worked into the grass with suitable equipment and shall be well watered. The quantity of fill soil shall be such that it will cause no smothering of the grass.

4. If sod is placed after September 15, final acceptance on the grass will not occur until after April 15. The grass shall not be over-seeded with rye. The Contractor shall water the grass until the grass is accepted.

C. FERTILIZER:

1. General: Fertilizer shall be an organic commercial product uniform in composition, free flowing, and suitable for application with approved equipment. Fertilizer shall be delivered to the site in fully labeled original containers. Fertilizer which has been exposed to high humidity and moisture, has become caked or otherwise damaged making it unsuitable for use, will not be acceptable.
2. Planting Application: Fertilizer shall be an organically based product (nutrients contained in the project shall be derived solely from the remains, part of the remains, or a by-product of a once-living organism) supplying nitrogen, phosphorus and potassium in a 1-1-1 to 5-5-5 analysis, such as Green Sense (3-1-2) or Sustane (5-4-2), or approved alternate formulation. The fertilizer shall contain a variety of cultures of soil-borne bacteria and trace elements, and be high (min. 18% each) in humus and humic acid. The Contractor shall submit a sample label or specification of the fertilizer proposed to be used for the City's approval. The specified fertilizer shall be applied at the rate of twenty (20) pounds per one thousand (1,000) square feet according to specific label. Fertilizer shall be applied over sodded areas after planting, but not more than two (2) days later.

D. HERBICIDES:

1. General: Herbicides will be applied as necessary for the eradication of weeds. The Contractor will choose an appropriate herbicide for application with respect to the kind of turfgrass being planted, climatic conditions, site conditions, and the state of work and the approved City chemical list available through the Parks Department. The applied herbicides shall not be detrimental to the establishment of turfgrass. Herbicides shall be approved for application by relevant U.S. Government agencies such as the U.S. Department of Agriculture and the Environmental Protection Agency. A pre-emergent that will not cause root pruning of new sod must be applied when sod is laid.
2. Application: The rates and methods of application shall be in strict conformance with local, state and federal laws and regulations. Applications shall follow the manufacturer's recommendations. All applications must be licensed by Texas Structural Pest Control Board or Texas Department of Agriculture.

3. Weed Control: The Contractor shall apply appropriate herbicides in the following situations:
 - a. Where weeds are present in the prepared soil, prior to the commencement of planting operations.
 - b. Where weeds are present in the planted turfgrass areas, prior to the establishment of the turfgrass to a uniform stand.
 - c. In the planted turfgrass areas, where the presence of weeds precludes the acceptability of the turfgrass as a uniform stand.
 - d. In other situations where the City judges that the presence of weeds is detrimental to the establishment or acceptability of the turfgrass.

- E. PLACEMENT: All turfing operations shall be executed across the slope, parallel to finished grade contours.

- F. SOIL PREPARATION:
 1. Scarification: Scarification shall be accomplished to loosen the soil, destroy existing vegetation, and prepare an acceptable sod bed. Initial tillage shall be done in a crossing pattern for double coverage, then followed by a disc harrow. Depth of scarification shall be 1-inch to 1½-inches.
 2. Cleaning: Soil shall be further prepared by the removal of debris, building materials, rubbish, weeds, and stones larger than 2-inches in diameter. During the soil preparation process, a "Rock Pick" or other approved piece of machinery shall be used to gather surface stones as small as 1-inch in diameter. The Contractor shall be responsible for the disposal of collected materials.
 3. Fine Grading: After scarifying and cleaning, all areas to be planted shall be leveled, fine graded, and dragged with a weighted spike harrow or float drag. The required result shall be the elimination of ruts, depressions, humps, and objectionable soil clods. Unless specified by the City medians shall be crowned in the center with cross slopes of approximately two percent (2%). This shall be the final soil preparation step to be completed before the commencement of fertilizing and planting.
 4. City shall approve bed preparation before grass planting begins.

- G. PROTECTION: No heavy equipment shall be moved over the planted lawn area unless the soil is again prepared, graded, leveled and replanted. It will be the responsibility of this Contractor to protect all paving surfaces, curbs, utilities, plant materials, and any other existing improvements from damage. Any damage shall be repaired or replaced as soon as possible at no cost to the City. The City may repair emergency conditions or noncompliance hazards at the cost of the Contractor.

H. ESTABLISHMENT AND ACCEPTANCE: Regardless of unseasonable climatic conditions or other adverse conditions affecting planting operations and the growth of the turfgrass, it shall be the sole responsibility of the Contractor to ESTABLISH A UNIFORM STAND OF TURFGRASS AS HEREIN SPECIFIED. When adverse conditions such as drought, cold weather, high winds, excessive precipitation, or other factors prevail to such an extent that satisfactory results are unlikely, the City may stop any phase of the work until conditions change to favor the establishment of turfgrass.

1. Uniform Stand of Turfgrass: A uniform stand with complete coverage of the specified grass shall be defined as not less than one hundred fifty (150) growing plants per square foot. Growing plants shall be defined as healthy grass plants of two blades or more at least 1½-inches tall. A uniform stand of turfgrass shall be free of weeds. No payment will be made for turfgrass until a uniform stand of grass has been established. Partial projects will not be accepted. A uniform stand of grass over 4-inches in height will not be accepted.
2. Thirty (30) days following planting, the City will inspect the medians to verify establishment as described above. Contractor will be required to replant and/or maintain any areas of grass that are unacceptable to the City until they meet the standards above.

I. MAINTENANCE: Maintenance shall begin immediately after each portion of grass area is planted. All planted areas will be protected and maintained by watering, weed control, and replanting as necessary to establish a UNIFORM STAND WITH COMPLETE COVERAGE OF THE SPECIFIED GRASS. The entire project will continue to be replanted and maintained by the Contractor until complete coverage and acceptance are achieved over one hundred percent (100%) of the area. Any water equipment deemed necessary by the Contractor will be provided by the Contractor.

1. Watering: Use a temporary irrigation system to irrigate the entire planted area daily for the first ten (10) days on which less than ½-inch of rain has fallen in the previous twenty-four hours and then two (2) times per week for the balance of the month following planting. Water trucks will be permitted as a means of irrigating the sodded areas.
2. Weed Control: Appropriate herbicides shall be applied as necessary as previously specified.
3. Grass shall be edged where it is adjacent to concrete areas.
4. All concrete areas where weeds are growing in the joints must be trimmed or chemically sprayed. These areas must have all growth removed.
5. Ant infestations must be treated with Award, Amdro or approved equivalent.

- J. GRADING: It is the Contractor's responsibility to maintain the existing grades and leave them in a true and even condition after planting turfgrass.
- K. EROSION CONTROL: Throughout the project and the maintenance period for turfgrass, it is the Contractor's responsibility to maintain the topsoil in place at specified grades. Topsoil and turfgrass losses due to erosion will be replaced by the Contractor until establishment and acceptance is achieved.
- L. CLEAN-UP: The Contractor shall remove any excess material or debris brought onto the site or unearthed as a result of his/her turfgrass operations.
- M. GUARANTEE: The Contractor shall guarantee all materials used for this work to be type, quality, and quantity specified.

12-47 FINAL CLEANUP: The intent of this section is to ensure that an adequate cleanup job be performed by the Contractor. Prior to accepting the project by the City, Contractor shall sweep and remove all trash, debris and remnants from all locations or areas affected by construction activities. All necessary cleanup work shall be considered subsidiary to the various bid items on this contract.

12-48 FINAL INSPECTION: The City will make final inspection of all work included in the contract as soon as practicable after the work is completed and ready for acceptance. If the work is not acceptable at the time of such inspection, the City will inform the Contractor as to the particular defects to be remedied before final acceptance will be made.

END OF SECTION

SECTION NO. 13

SPECIAL PROVISIONS – PAVING SPECIFICATIONS

NUMERICAL LISTING

Section No.

13-01	ROADWAY EXCAVATION
13-02	COMPACTED ROADWAY FILL & EMBANKMENT
13-03	CEMENT TREATED BASE (CTB)
13-04	HYDRATED LIME
13-05	LIME AND CEMENT TREATED SUBGRADE
13-06	CEMENT TREATED SUBGRADE
13-07	EPOXY BONDING AGENT
13-08	MISCELLANEOUS CONCRETE TESTING REQUIREMENTS
13-09	RECONSTRUCT DRIVES
13-10	CONCRETE CURB AND GUTTER
13-11	CONCRETE VALLEY GUTTERS
13-12	CONCRETE DRIVEWAYS
13-13	CONCRETE SIDEWALKS
13-14	BARRIER FREE RAMPS
13-15	CONCRETE PANEL REPLACEMENT
13-16	CONCRETE PAVEMENT
13-17	CONCRETE MEDIANS
13-18	MEMBRANE CURING
13-19	ASPHALTIC PRIME COAT
13-20	TACK COAT
13-21	NON-TRACKING TACK COAT
13-22	HOT MIX ASPHALTIC CONCRETE
13-23	PAVING FABRIC (PETRO-MAT)
13-24	STEEL GUARD RAIL
13-25	GPS MONUMENT
13-26	TEMPORARY BATCH PLANT

SECTION NO. 13

SPECIAL PROVISIONS – PAVING SPECIFICATIONS

13-01 ROADWAY EXCAVATION:

- A. All roadway excavation on this project shall be unclassified and shall be performed in full accordance with the C.O.G. SPECIFICATIONS, Division 200, 203.4, "Unclassified Street Excavation."
- B. Payment for excavation is based on plan quantity. Contractor shall verify excavation/fill quantities and shall notify City in writing of concurrence or disagreement with plan quantities prior to start of construction. Any discrepancies in quantities shall be resolved prior to beginning excavation. No adjustments to plan quantities shall be allowed once excavation/fill activities have begun.
- C. The placement and compaction of fill material in roadway fill areas on this project shall be measured by the cubic yard in place and paid separately from roadway excavation as specified in the item "Compacted Roadway Fill & Embankment". It shall be the responsibility of the Contractor to locate a suitable disposal site outside the right-of-way limits to dispose of both excess and unsuitable material from roadway excavation not needed in roadway fill and embankment. No separate payment shall be made for disposal of excess or unsuitable material. Disposal shall be performed in accordance with appropriate laws and ordinances.
- D. If you are planning on taking fill material from projects to the City of Arlington landfill, please be aware that the landfill operator, Republic Services, has requirements to ensure fill material is acceptable. Please contact Republic Services at (817) 354-2300 directly to obtain details of the requirements.

13-02 COMPACTED ROADWAY FILL & EMBANKMENT:

- A. All compacted roadway fill and embankments constructed on this project shall be in accordance with the C.O.G. SPECIFICATIONS, Division 200, 203.7, "Embankment", except as amended herein or as shown on the plans.
- B. All fill material shall be compacted in lifts of loose depth not exceeding 8-inches and compacted to at least ninety-five percent (95%) density per ASTM D698, +/- two percent (2%) optimum moisture content. Each lift shall be tested before a subsequent lift is allowed to be placed. It shall be the responsibility of the Contractor to locate a suitable disposal site outside the right-of-way limits and to dispose of any excess material not needed for constructing embankments to the established grade, shape of the typical sections shown on the plans, and detailed sections or slopes. Disposal shall be performed in accordance with appropriate laws and ordinances.
- C. The placement and compaction of fill material in roadway and embankment areas on this project shall be measured and paid for separately from the "Roadway Excavation". However, no separate payment will be made for the disposal of excess materials as mentioned above. Measurement for compacted roadway fill and embankment shall be for

in-place embankment after compaction to the density specified on the plans. Measurement shall be in cubic yards as determined on the basis of the natural ground cross-section and the finished lines and grades as shown in the plans and computed by the method of average end areas from the project cross-section.

- D. The price bid per cubic yard for "Compacted Roadway Fill and Embankment" shall be full compensation for furnishing all labor, materials, tools, equipment, and incidentals necessary to complete the embankment, including cost of water, sprinkling, wetting, and rolling in accordance with the plans and specifications.

13-03 CEMENT TREATED BASE (CTB):

- A. Cement Treated Base shall be in accordance with TxDOT Standard Specification, Item 276. Use strength "L". In any areas where the City determines the subgrade is unstable or unsuitable, the subgrade material shall be removed and be replaced with CTB compacted to ninety-five percent (95%) of TEX-113E at optimum to plus four percent (4%). Unless a separate item is included in the PROPOSAL, CTB shall be subsidiary.
- B. In emergency situations, the City may approve flexible base in lieu of CTB. The flexible base shall be Type "A", Grade 1 Flex Base in accordance with TxDOT Standard Specification Item 247.

13-04 HYDRATED LIME: The hydrated lime to be used on this job shall conform to COG Specification Item 301.2 with the exception of 301.2.1.2 Quicklime. No Quicklime will be allowed on this project unless otherwise approved by the City.

13-05 LIME AND CEMENT TREATED SUBGRADE:

- A. This item shall consist of treating the subgrade by scarifying, addition of lime slurry, initial mixing and curing, re-scarifying, addition of cement slurry, final mixing and compacting the material to the required density. This item applies to the subgrade, i.e., natural ground, embankment or existing pavement structure and shall be constructed as specified herein and in conformity with the typical sections, lines and grades as shown on the Plans or as established by the City.

B. **MATERIALS:**

1. **Soil**

- a. Soil shall consist of approved material free from roots, vegetation or other objectionable matter encountered in the subgrade. Rocks or similar debris larger than 4-inches shall be removed from the subgrade prior to treatment. Acceptable material shall also be used in preparation of the roadbed in accordance with this specification. Prior to beginning subgrade treatment, the area to be treated shall be brought to the required line, grade, cross-section, and proof rolled in accordance with the latest TxDOT Standard Specifications.
- b. Any identified soft or unstable areas shall be excavated and re-compacted with acceptable material to ninety-five percent (95%) density per TEX 113E. Moisture content shall range from zero percent (0%) to + four percent (4%) optimum. Any unsuitable or deleterious material found shall be removed and

disposed of. The cost of proof rolling shall be considered subsidiary to this item.

2. Lime

- a. The Contractor can use Type "A", Hydrated Lime (a dry powdered material consisting essentially of calcium hydroxide) or Type C, Quicklime-Grades DS and "S" (a dry material consisting essentially of calcium oxide), to produce a lime slurry or Type "B", Commercial Lime Slurry (a liquid mixture of essentially hydrated lime solids and water in slurry form). The lime and lime slurry shall meet the latest version of TxDOT Department of Material and Testing, DMS 6350.
- b. All slurry shall be furnished at or above the minimum "Dry Solids" content as approved by the City and must be of a consistency that can be handled and uniformly applied without difficulty. The slurry shall be free of liquids other than water.
- c. Hydrated lime shall be stored and handled in closed weatherproof/waterproof containers until immediately before distribution on the roadway subgrade. If lime is furnished in trucks, each truck shall have the weight of lime certified on public scales or the Contractor shall place a set of standard platform truck scales or hopper scales at the location provided by the City.

3. Portland Cement

- a. Portland Cement shall be Type I, unless otherwise directed by the City. All apparatus for handling, weighing and spreading the cement shall be approved by the City in writing before use on the project. Cement weighing and distribution equipment shall be as specified below.
- b. Portland cement shall be stored and handled in closed weatherproof/waterproof containers until immediately before distribution on the roadway subgrade. If cement is furnished in trucks, each truck shall have the weight of cement certified on public scales or the Contractor shall place a set of standard platform truck scales or hopper scales at the location approved by the City.

4. Water

Water shall be clean and free of oil, acid, alkali, organic matter, or other deleterious substances.

B. EQUIPMENT:

1. The machinery, tools and equipment necessary for proper execution of the work shall be on the project, approved by the City prior to the beginning of the construction operations and be maintained in good working order.
2. Slurry distribution trucks must be equipped with an agitator to keep the additive (Hydrated Lime or Cement, as appropriate) and water in a homogeneous suspension.

Mixture shall be uniform in consistency from beginning to end of the distribution operation.

3. When the Contractor elects to use a cutting and pulverizing machine that will process the material to the plan depth, the Contractor will not be required to excavate to the secondary grade or windrow the material. This method will be permitted only if a machine is provided which will ensure that the material is cut uniformly to the proper depth and provide a smooth surface over the entire width of the cut. The machine shall have a visible indicator that the machine is cutting to the proper depth at all times.

C. CONSTRUCTION METHODS:

1. General

- a. Contractor shall verify, identify, and maintain marked locations of all water valves, sanitary sewer manholes, and cleanouts at all times during construction. Prior to the application of cement or lime slurry, all manholes, cleanouts, and water valves shall be adjusted to approximately 1-foot below the bottom of the proposed subgrade.
- b. It is the primary requirement of this specification to secure a completed course of treated material containing a uniform blend of lime and cement, free from loose or segregated areas, of uniform density and moisture content for its full depth and with a smooth surface suitable for placing subsequent courses. It shall be the responsibility of the Contractor to regulate the sequence of his/her work, to use the proper amount of lime and cement, maintain the work and rework the courses as necessary to meet the above requirements.
- c. The roadbed shall be constructed and shaped to conform to the typical sections, lines, and grades as shown on the Plans or as established by the City. The subgrade shall be firm and able to support, without significant displacement, the construction equipment and obtain the compaction herein specified.

2. Lime Modification

- a. Prior to beginning any lime modification, the subgrade shall be brought to the required line, grades and cross-section in accordance with the specification requirements.
- b. After the subgrade has been shaped, the roadway will be scarified to full depth and width of modification. Full depth will be a minimum of 8-inches below finished grade or as indicated on the Plans. Full width will be that distance from 1-foot behind the back of curb on each side of the roadway. Scarification shall be accomplished using a motor grader with short teeth, or other appropriate means assuring accurate depth of scarification.

i. Lime Slurry Placement

Lime will be applied by the "slurry" method and be spread only on that area where the mixing and sealing operations can be continuous and completed in one operation. The lime slurry will be applied with an approved distributor truck by making multiple passes, if necessary, to uniformly apply the correct amount of lime as specified in the Plans. The distributor truck will be equipped with an agitator to keep the lime slurry in constant mixture.

ii. Application

For applications greater than forty-two (42) pounds per square yard, the initial application shall be applied in halves (two equal parts) on day one (1) and day two (2). This is subsidiary to the lime stabilization item.

iii. Initial Mixing

Immediately following lime application, thoroughly mix the slurry into the subgrade with a pulvimixer until one hundred percent (100%) of all material will pass a 2-inches sieve. If necessary, make passes at various angles across the site to facilitate breaking up of large clods. The lime modified material shall then be rolled with pneumatic roller to seal the lift and left to cure for a minimum of twenty-four (24) hours. During the curing period, the subgrade shall be kept at least two percent (2%) above its optimum moisture content.

3. Cement Stabilization

- a. Prior to beginning any cement stabilization, the previously treated subgrade shall be re-scarified to full depth and width of modification. Full depth will extend to the underlying untreated material but must not extend into the underlying untreated material. Full width will be that distance from 1-foot behind the back of curb on each side of the roadway. Scarification shall be accomplished using a motor grader with short teeth, or other appropriate means assuring accurate depth of scarification.

i. Application of Cement

Cement shall be applied by the "slurry" method. The cement shall be mixed with water to form a slurry of the solids content designated by the City. The amount of cement to be added will be shown on the plans or indicated in the contract documents.

Cement shall be spread only in that area where the mixing, compacting, and finishing operations can be continuous and completed within six (6) hours of addition of water.

Cement slurry shall be applied with an approved distributor truck by making multiple passes, if necessary, to uniformly apply the correct amount of cement as specified in the Plans or contract documents. The distributor truck shall be equipped with an agitator to keep the cement slurry in a consistent mixture. The cement slurry must be dispensed as soon as

practical, but within a maximum of ninety (90) minutes from the addition of cement to the slurry water.

Unless otherwise approved by the City, the cement treatment operation shall not be started until ambient temperature reaches thirty-five (35) degrees with a projected high of forty (40) degrees (minimum). Operations shall cease when temperature falls below forty (40) degrees. The temperature will be taken in the shade and away from artificial heat. Cement shall not be placed when weather conditions in the opinion of the City are unsuitable.

Dry application will not be allowed unless approved by the City. If approved, the cement shall be spread by an approved spreader or by bag distribution. It shall be distributed at a uniform rate and in such a manner as to reduce to a minimum the scattering of cement by wind. Cement shall not be applied when wind conditions, in the opinion of the City, are such that blowing cement becomes objectionable to adjacent property owners or dangerous to traffic.

b. Final Mixing

- i. Immediately following cement slurry application, thoroughly mix the slurry into the subgrade with a pulvimixer. If necessary, make passes at various angles across the site to facilitate breaking up of oversized clods. The previously lime treated material and cement slurry shall be thoroughly mixed until, in the opinion of the City, a homogeneous, friable mixture of material and cement is obtained, free of all clods or lumps. Materials shall be mixed as thoroughly as possible at the time of the cement application and brought to a minimum of two (2) percent above its optimum moisture content. The material shall be kept moist as directed by the City.
- ii. If the cement-modified soil mixture contains clods, they shall be reduced in size by raking, blading, discing, harrowing, scarifying or the use of other approved pulverization methods to achieve the following gradation:

Minimum Passing 1½-inches Sieve	100%
Minimum Passing No. 4 Sieve	60%

4. Final Compaction

- a. Compaction of the subgrade shall begin immediately after final mixing and after final gradation has been met. Final compaction of the subgrade shall be complete within six (6) hours of introduction of water to cement.
- b. The subgrade shall be sprinkled, if necessary, and compacted to provide the density specified below as determined by the use of TEX 113-E. Testing shall occur after the subgrade is brought to the required lines and grades shown on the Typical Sections and Plans or as specified by the City.

Description	Density, Percent	Moisture, Percent
For cement-modified subgrade that will receive subsequent courses	Not less than 95, except when shown otherwise on the Plans.	Optimum to plus 4% unless otherwise shown on the Plans

- c. The testing will be as outlined in Test Method ASTM D 2922 and ASTM D3017 or other approved methods. In-place density tests shall be performed at the minimum of one test per three hundred (300) linear feet of paving for two (2) lanes. If the material fails to meet these density requirements it shall be reworked as necessary to meet said requirements. Reapplication of cement slurry will be required. to aid in recovering lost strength from reworking. Throughout this entire operation, the shape of the course shall be smooth and in conformity with the Typical Sections shown on the Plans and to the established lines and grades. Should the material due to any reason or cause lose the required stability, density and finish before the next course is placed or the work is accepted, it shall have cement incorporated at originally specified rate, remixing, and be recompact and refinished at the sole expense of the Contractor.
- d. Finishing of the completed section shall be accomplished by rolling as directed with a pneumatic tire or other suitable roller sufficiently light to prevent hair cracking.

D. MAINTENANCE OF SUBGRADE CONDITION:

- 1. The Contractor shall make provisions for maintaining the compacted subgrade in a moist condition for a secondary curing time. The requirement is to maintain the in-situ moisture at least two (2) percentage points above optimum conditions throughout the treated section. This is to be accomplished by frequent light sprinkling of the surface. During this secondary curing time, all construction vehicles shall be prohibited from the subgrade for a minimum of two (2) days.
- 2. The Contractor shall maintain the completed subgrade within the limits of his/her contract in good condition, satisfactory to the City as to grade, crown and cross section until such time as the surface course is constructed. All irregularities or other defects that may occur shall be repaired by the Contractor as his/her expense.
- 3. All over-excavated areas (shy grade) will require additional depth of pavement. No additional cement treated subgrade will be allowed on top of the initially processed grade (no scabbing).
- 4. The moisture content of the prepared subgrade shall be maintained at optimum or above until the next subsequent pavement course is installed. If this moisture decreases below optimum, the incorporation of additional moisture by scarifying and

re-compaction the prepared grade will not be permitted. If at any time the prepared subgrade needs to be disturbed to incorporate moisture or when subgrade has been exposed for more than thirty (30) days, an additional application of cement at one hundred percent (100%) of the original application rate of cement will be required. NO additional payment shall be made if these additional cement applications are required.

E. MEASUREMENT AND PAYMENT:

1. This work shall be measured by the square yard of completed and accepted lime modified / cement stabilized treated subgrade. Measurement of both the lime and cement shall be per ton of dry weight, as determined by certified weight tickets. No allowance shall be made for any materials used or work done outside the limits shown on the Plans and Typical Sections. The work performed and material furnished as prescribed by this item and measured as provide in this item shall be paid for at the unit price bid for lime modified / cement stabilized soil, which price shall be full compensation for scarifying the soil materials; for handling; hauling and spreading the lime slurry; for mixing the lime slurry into the subgrade; for roll sealing and curing the subgrade; for re-scarifying the lime modified subgrade; for handling; hauling and spreading the cement slurry; for mixing the cement slurry into the lime modified subgrade; for establishing final gradation; for spreading and shaping the mixture; compacting the mixture, including all rolling required for this compaction; surface finishing; and for all manipulation, labor, equipment, appliances, tools and incidentals necessary to complete the work and carry out the maintenance provisions in this specification.
2. Lime and cement materials measured as provided in this item shall be paid for at the unit price bid for lime and cement materials, which price shall be compensation for furnishing the material; for all freight involved, for all unloading and storing; and for all labor, equipment, fuels, tools and incidentals necessary to complete the work, all in accordance with the Plans and these Specifications.

13-06 CEMENT TREATED SUBGRADE:

A. DESCRIPTION:

1. This item shall govern for treating subgrade, by the addition of portland cement and mixing and compacting the treated material to the required density, as herein specified and in conformity with the typical sections, lines, grades and thickness as shown on the plans or as established by the City.
2. Portland cement shall be Type I unless otherwise directed by City.

B. EQUIPMENT: The machinery, tools, and equipment necessary for proper execution of the work shall be on the project and approved by the City prior to beginning work on this item. All machinery, tools, and equipment used shall be maintained in a satisfactory working condition.

C. CONSTRUCTION METHODS:

1. General

- a. Contractor shall verify, identify, and maintain marked locations of all water valves, sanitary sewer manholes, and cleanouts at all times during construction. Prior to the application of cement or lime slurry, all manholes, cleanouts, and water valves shall be adjusted to approximately 1-foot below the bottom of the proposed subgrade.
 - b. The completed course shall be uniformly treated, free from loose or segregated areas, of uniform density and moisture content for its full depth and shall have a smooth surface.
2. Preparation of Subgrade or Existing Base
- a. Prior to scarifying or mixing existing material, the subgrade or existing base shall be shaped to conform to the typical sections as shown on the plans or as established by the City. This work shall be done in accordance with the provisions of the applicable bid Items.
 - b. The Contractor shall proof roll the roadbed before mixing or scarifying existing material. Soft spots shall be corrected as directed by the City at no additional cost.
 - c. When the Contractor elects to use a cutting and pulverizing machine that will process the material to the plan depth, the Contractor will not be required to excavate to the secondary grade or windrow the material. This method will be permitted only if a machine is provided which will ensure that the material is cut uniformly to the proper depth and provide a smooth surface over the entire width of the cut. The machine shall have a visible indicator that the machine is cutting to the proper depth at all times.
3. Gradation The existing material as shown on the typical section shall be mixed so that a minimum of eighty percent (80%) shall pass the No. 4 sieve.
4. Application of Cement
- a. Cement shall be applied by the "slurry" method. The cement shall be mixed with water to form a slurry of the solids content designated by the City. The amount of cement to be added will be shown on the plans or indicated in the contract documents.
 - b. Cement shall be spread only in that area where the mixing, compacting, and finishing operations can be continuous and completed within six (6) hours of addition of water.
 - c. Cement slurry shall be applied with an approved distributor truck by making multiple passes, if necessary, to uniformly apply the correct amount of cement as specified in the Plans or contract documents. The distributor truck shall be equipped with an agitator to keep the cement slurry in a consistent mixture. The cement slurry must be dispensed as soon as practical, but within a maximum of

ninety (90) minutes from the addition of cement to the slurry water.

- d. Unless otherwise approved by the City, the cement treatment operation shall not be started until ambient temperature reaches thirty-five (35) degrees with a projected high of forty (40) degrees (minimum). Operations shall cease when temperature falls below forty (40) degrees. The temperature will be taken in the shade and away from artificial heat. Cement shall not be placed when weather conditions in the opinion of the City are unsuitable.
- e. Dry application will not be allowed unless approved by the City. If approved, the cement shall be spread by an approved spreader or by bag distribution. It shall be distributed at a uniform rate and in such a manner as to reduce to a minimum the scattering of cement by wind. Cement shall not be applied when wind conditions, in the opinion of the City, are such that blowing cement becomes objectionable to adjacent property owners or dangerous to traffic.

5. Mixing

Only single or multiple soil stabilizer mixers shall be used.

6. Compaction Methods

- a. Compaction shall continue until the entire thickness of the mixture is uniformly compacted.
- b. The treated material shall be sprinkled and rolled as directed by the City. All irregularities, depressions or weak spots which develop shall be corrected immediately by scarifying the areas affected, adding or removing treated material as required, reshaping, and re-compacting at the Contractor's expense. Any reworked area must be completed within the six (6) hour window.
- c. Should the material lose the required stability, finish or fail to meet the density requirements before the next course is placed, it shall be removed and replaced at the Contractor's expense.

7. Density Control

Unless otherwise shown on the plans, the course shall be sprinkled as required herein and compacted to the extent necessary to provide not less than ninety-five percent (95%) density per TEX 113E. Moisture content shall range from zero percent (0%) to plus four percent (4%) optimum.

8. Finishing

- a. Immediately after compaction, the surface of the mixture shall be clipped, skinned, or tight bladed by a maintainer or subgrade trimmer to a depth of approximately 1/4-inch, removing all loosened materials. The loosened materials shall be disposed of at the Contractor's expense. The surface shall then be rolled with a pneumatic tire roller, adding small increments of moisture as needed during rolling.

- b. Throughout this operation, the shape of the course shall be maintained and the surface upon completion shall be smooth and in conformity with the typical sections, lines and grades as shown on the plans or as established by the City.

9. Curing

The completed section shall be moist cured for three (3) days or prevented from drying by addition of an AEP (Asphalt Emulsion Prime) 50/50 at the rate of 0.15 to 0.20 gallon per square yard as determined by the City. The asphalt used shall be of the type and grade shown as on the plans or as approved by the engineer.

- D. TOLERANCES: Grade Tolerances. In areas on which pavement is to be placed, any deviation in excess of 1/4-inch in cross section and 1/4-inch in 16-foot measured longitudinally shall be corrected by loosening, or removing material, reshaping, and compacting by sprinkling and rolling.

E. MEASUREMENT AND PAYMENT:

1. Cement treated subgrade will be measured by the square yard of the surface area to the lines and grades shown on the typical sections. The work performed and equipment furnished in accordance with this Item will be paid for at the unit price bid for "Cement treated subgrade". This price shall be full compensation for the preparation and manipulation of the subgrade, which includes, shaping existing material, loosening, proof rolling, spreading, mixing, compacting, blading, shaping, finishing, curing including curing materials, replacing if required, and for all mixing water, labor, tools and incidentals necessary to complete the work except as otherwise provided for in this specification.
2. Cement will be measured and paid for at the unit price bid per ton of, dry weight.

13-07 EPOXY BONDING AGENT: Epoxy used shall be in accordance with TxDOT DMS-6100 Epoxies and Adhesives specifications.

13-08 MISCELLANEOUS CONCRETE TESTING REQUIREMENTS:

- A. The strength of the concrete shall be determined during the construction by taking a minimum of four (4) test cylinders during each fifty (50) cubic yards of continuous placement. These tests shall be conducted by an approved testing laboratory and the initial tests shall be paid for by the City. The cost of additional testing to isolate areas not complying with the specifications shall be paid for by the Contractor.
- B. Strength tests permitted by the specifications for early form removal shall be conducted by an approved testing laboratory and the cost shall be borne by the Contractor.

13-09 RECONSTRUCT DRIVES:

- A. Existing drives which will be affected by proposed construction and which will be reconstructed are specifically called out on the plans. After construction operations are completed in the street area, these drives shall be reconstructed to original or better

condition than existed before construction and to satisfaction of the City. Existing surface and base materials and storm drain pipe may be reused if approved by the City.

- B. All work shall conform to the applicable standard and special project specifications. Work shall include all materials, labor, and supervision for the reconstructing the drives and be paid per unit price as stated in the PROPOSAL.

13-10 CONCRETE CURB AND GUTTER:

- A. Concrete curb and gutter shall be placed at locations along the project where portions of the existing curb and gutter is removed. Unless otherwise approved by the City, all curb and gutter shall be standard 30-inches curb and gutter sections and be replaced at a minimum thickness of 6-inches or match existing curb and gutter thickness, whichever is greater. Contractor shall remove additional 8-inches thick, 1-foot back of curb of existing material under new curb and gutter limits and replace with 8-inches CTB compacted to ninety-five percent (95%) TEX-113E at optimum to plus four percent (4%).
- B. All concrete used for curb and gutter in the City will have a cement content of not less than five and a half (5.5) sacks of cement per cubic yard of concrete, four and a half percent (4.5%) entrained air (+/- 1.5%), and a minimum compressive strength at twenty-eight (28) days of thirty-six hundred (3,600) pounds per square inch. The unit price bid for curb and gutter shall include all reinforcing steel, including No. 4 “L” bars at every 18-inches. Curb & gutter, including additional excavation and CTB will be paid by the linear foot.
- C. Expansion joints shall be placed at all intersections, P.Cs, P.Ts, driveways, inlets, other curb and gutter or every 200-feet. Tooled joints shall be placed at every 5-foot intervals. All expansion joints shall not be less than ½-inch in thickness with longitudinal dowels. Dowels shall be three No. 4 smooth bars, 24-inches in length. One-half of the dowel shall be coated with asphalt and terminated with an expansion cap.
- D. All work shall be in compliance with C.O.G. Section 305.1. All loose material between the forms will be removed and the grade wetted prior to the placing of the concrete. An approved curing compound shall be applied to the surface in accordance with the Curing Specification. All curbs shall be vibrated to eliminate “honeycomb” appearance.
- E. Locations where homeowners have installed drain pipes that run through the curb, curb opening casting will be required to discharge water through the curb. Drain outfall (R3262 Neenah Foundry or equivalent) shall be installed flush with the curb and the location be approved by the City prior to installation. It is the Contractor’s responsibility to connect existing pipe to the curb opening casting and ensure connection is secure with no water leaks or dirt infiltration.

13-11 CONCRETE VALLEY GUTTERS:

- A. All concrete valley gutters shall have a minimum thickness of 6-inches on residential streets and 8-inches on collector or larger streets. Contractor shall remove additional 8-inches of existing material under proposed valley gutter limits and replace with 8-inches CTB compacted to ninety-five percent (95%) TEX-113E at optimum to plus four percent

(4%). Concrete valley gutters shall be reinforced with No. 4 bars on 12-inches spacing in both directions.

- B. All concrete shall have a minimum cement content of five and a half (5.5) sacks per cubic yard of concrete, four and a half percent (4.5%) entrained air (+/- 1.5%) and a minimum compressive strength at twenty-eight (28) days of thirty-six hundred (3,600) pounds per square inch. All concrete shall be vibrated and an approved curing compound shall be applied to the surface.

13-12 CONCRETE DRIVEWAYS:

- A. All concrete driveways shall have a minimum thickness of 5-inches for residential driveways and 6-inches for commercial driveways or shall match existing driveway thickness, whichever is greater.
- B. Driveways shall be composed of concrete having a minimum cement content of five and a half (5.5) sacks per cubic yard of concrete, four and a half percent (4.5%) entrained air (+/- 1.5%) and a minimum compressive strength at twenty-eight (28) days of thirty-six hundred (3,600) pounds per square inch. The unit bid price shall also include No. 4 bars on 18-inches centers both ways. All concrete shall be vibrated and an approved curing compound shall be applied to the surface.
- C. The City will replace only those existing driveways specified. Any new drives installed by the Contractor under criteria other than the above will be at his/her own expense.

13-13 CONCRETE SIDEWALKS:

A. MATERIALS:

- 1. Sidewalks shall have a minimum thickness of 4-inches and be constructed of concrete with a minimum cement content of five and a half (5.5) sacks of cement per cubic yard of concrete, four and a half percent (4.5%) entrained air (+/- 1.5%), and a compressive strength of not less than thirty-six hundred (3,600) pounds per square inch at twenty-eight (28) days. Reinforcing steel shall be No. 4 bars on 18-inches centers located 2-inches below the top surface of the sidewalk. All concrete shall be vibrated and as soon as the concrete has obtained its initial set, a white pigmented approved curing compound shall be applied to the surface. (Rev. 12/2020)

B. CONSTRUCTION PROCEDURE:

- 1. In general, the grade of the sidewalks shall be established with respect to the curb. Forms shall be set for all sidewalks and shall be true to line and grade. Forms shall be set to provide a cross slope of ¼-inch per foot (maximum) across the sidewalk toward the street. All forms shall remain in place at least twenty-four (24) hours.
- 2. The plane of all joints shall make a right angle with the surface of the pavement. No joints shall have an error in alignment of more than ½-inch at any point. The edges of the slab at all joints, except where the joints are sawed, shall be rounded with an edger having a radius of ¼-inch, except as otherwise shown on the plans. The edging shall also be done symmetrically on each section with the plane of the joint.

3. Longitudinal expansion joints, joints used to separate new from old concrete, and all joints around all fire hydrants shall be made of conventional ¾-inch asphalt expansion joint material extending completely through the concrete unless otherwise specified on the plans.
4. Transverse expansion joints shall be ¾-inch in width and be made of high grade redwood with removable ¾-inch wide by 1-inch deep cap strip or with asphalt expansion material with removable cap strip, sealed with self-leveling gray silicon sealant. Joints shall be placed through the concrete at a spacing not to exceed 40-feet. 24-inches, No. 4 smooth steel dowels shall be placed on 12-inches centers through each expansion joint, one end of each dowel being wrapped or otherwise prevented from bonding to the concrete.
5. Contraction joints shall be made in the sidewalk at regular intervals, such intervals generally being equal to the width of the sidewalk.
6. The Contractor shall grade or fill, as necessary, along the sidewalk to match the existing ground. Care will be used to ensure that adjacent property outside the right-of-way line is protected.
7. When sidewalks are constructed adjacent to retaining walls, the plans shall specify if the sidewalk and retaining wall are to be constructed as separate items or as a sidewalk with wall unit. The sidewalk with wall unit shall be constructed in accordance with the City typical details. When specified to be constructed as separate items, the limits of pay for the sidewalk shall be all of the sidewalks up to the face of the retaining wall. The retaining wall shall be paid under retaining wall on a cubic yard basis.
8. Unless otherwise approved by the City, nothing shall be installed in the sidewalks, including but not limited to meters, meter boxes, valves, fire hydrants, manholes, and sign poles.

13-14 BARRIER FREE RAMPS:

- A. Sidewalks shall be constructed barrier free and fully accessible. Curb ramps are required at all intersections between sidewalks and streets. At driveways, the curb shall be laid down and the sidewalk section shall be maintained through the driveway. All concrete shall be vibrated and the ramps be constructed in accordance with the detail shown on the plans.
- B. Ramp slopes shall not exceed 8.33%. All ramps shall be constructed with current ADA standards, including Colonial Red (Federal Color No. 20109) Cast In Place Detectable/Tactile Warning Surface Tile as manufactured by Armor Tile or 4-inches x 8-inches x 2¼-inches ADA compliant detectable warning pavers in Antique (shade No. 32)

as manufactured by Whitacre-Greer or in River Red as manufactured by Pavestone, or approved equal.

- C. All incidentals, including but not limited to, the transition, the landings, curb, pavers and sidewalks all the way to the tie-in as necessary to meet ADA compliance, the concrete below the detectable warning device, the bedding sand shall be subsidiary to the unit price bid for each ramp.

13-15 CONCRETE PANEL REPLACEMENT:

- A. The contractor shall perform an elevation survey of all segments and establish removal and replacement limits to ensure ponding water will not exist after construction. Contractor shall provide cut sheets clearly showing concrete removal limits to the City for review and approval prior to starting construction. Survey shall include enough information to evaluate drainage of the street and adjacent properties. The City will make the final determination as to the limits of the concrete replacement. Payment to complete this work and survey will be considered subsidiary to the bid item. (Rev. 11/2019)
- B. All concrete paving shall be replaced at a minimum thickness of 8-inches or shall match existing pavement thickness, whichever is greater. Paving shall include 8-inches of Cement Treated Base (CTB) and be reinforced with No. 4 rebar on 18-inches spacing both directions. Contractor shall drill 6-inches into existing pavement to accomplish tie-in with No. 4 rebar, 30-inches in length, every 18-inches with epoxy.
- C. Any curb replacement associated with concrete paving shall be considered integral to the paving. All expansion joints in curbs shall conform to the joint locations in the slab. All expansion joints in the slab (newly replaced paving) shall conform to existing expansion joint unless otherwise approved by the Inspector. All joints shall be routed and sealed. All concrete shall be vibrated.
- D. Concrete trucks shall be discharged to achieve uniform placement across the entire width of the panel.

13-16 CONCRETE PAVEMENT:

- A. DESCRIPTION:
 - 1. This item shall consist of a pavement of portland cement concrete, with reinforcement as shown on plans, with or without monolithic curbs, constructed as herein specified on the prepared subgrade or other base course in conformity with the lines, grades, thickness and typical cross-sections shown on plans. Concrete shall be considered of satisfactory quality provided:
 - a. it is made of materials accepted for the job,
 - b. in the proportions approved by the City and
 - c. mixed, placed, finished and cured in accordance with the requirements of this specification and meets the requirements herein specified.
- B. MATERIALS:
 - 1. Cement

- a. The cement shall be Type 1 of a standard brand of portland cement. Type III cement shall be used when high early strength concrete is required by the plans or special provisions. If the use of high early strength cement is not specified, the Contractor desires to use it, he shall obtain written permission of the City and shall assume all additional costs incurred by the use of such cement. Type I and Type III cement shall conform to the requirements of ASTM Designation: C 150. When Type III cement is used, the average strength of briquettes at the age of seven (7) days shall be higher than that attained at three (3) days. Either the tensile or the compressive tests may be used for either type cement. In addition to the requirements of ASTM Designation C 150, the specific surface area of Type I cement shall not exceed two thousand (2,000) square centimeters per gram as measured by the Wagner Turbidimeter in accordance with Test Method Tex-310-D.
2. Admixtures
 - a. No admixtures shall be used in the concrete without prior approval, and all approved admixtures shall meet applicable AASHTO, ASTM, and CSA requirements.
 - b. Air-entraining agents shall have proven compatibility with all local concrete materials, including cement, and shall be capable of providing in the concrete the required air contents and an air-void system known to produce durable, scale-resistant concrete.
 - c. Admixtures other than air-entraining agents shall not be used until trial mixes with job materials have shown them to be compatible at job temperatures. Trial mixes must also show that desired properties will be imparted to the fresh concrete without any subsequent loss of strength or durability in the hardened concrete.
 - d. Air reducing agents will not be acceptable for use.
3. Coarse Aggregate
 - a. Coarse aggregate shall consist of durable crushed limestone of reasonably uniform quality throughout, free from injurious amounts of salt, alkali, vegetable matter or other objectionable material, either free or as an adherent coating on the aggregate. It shall not contain more than a quarter percent (0.25%) by weight of clay lumps, nor more than one percent (1%) by weight of shale nor more than five percent (5%) by weight of laminated and/or friable particles when tested in accordance with Test Method Tex-413-A.
 - b. Coarse aggregate shall have a wear of not more than thirty-eight percent (38%) when tested according to Test Method Tex-410-A, and shall meet the grading requirements of TxDOT Standard Specification 421.2 Table 3 for 1-inch or 1½-inches.

- c. Where the coarse aggregate is delivered on the job in two or more sizes or types, each type and/or size shall be batched and weighed separately.
 - d. A supply of aggregate adequate for two (2) days paving shall be stockpiled at the concrete plant. All aggregates shall be handled and stored in such a manner as to prevent size segregation and contamination by foreign substances. When segregation is apparent, the aggregate shall be remixed. At the time of its use, the aggregate shall be free from frozen material and aggregate containing foreign materials will be rejected. Coarse aggregate that contains more than half a percent (0.5%) free moisture by weight shall be stockpiled for at least twenty-four (24) hours prior to use.
 - e. Adequate storage facilities shall be provided for all approved materials. The intermixing of nonapproved materials with approved materials either in stockpiles or in bins will not be permitted. Aggregates from different sources shall be stored in different stockpiles unless otherwise approved by the City.
 - f. Each aggregate stockpile shall be reworked with suitable equipment at such times, as required by the City to remix the material to provide uniformity of the stockpile.
4. Fine Aggregate
- a. Fine Aggregate shall consist of sand or a combination of sands, and shall be composed of clear, hard, durable, uncoated grains. Fine aggregate shall be free from injurious amounts of salt, alkali or vegetable matter. Unless otherwise shown on plans, the acid insoluble residue of the fine aggregate shall be not less than twenty-eight percent (28%) by weight when tested in accordance with Test Method Tex-612-J.
 - b. It shall not contain more than half a percent (0.5%) of weight of clay lumps. It shall contain no more than twenty percent (20%) manufactured sand. When subjected to the color test for organic impurities, Test Method Tex-408-A, the fine aggregate shall not show a color darker than the standard.
 - c. When the fine aggregate is tested in accordance with Test Method Tex-317-D, it shall have tensile strength of mortar equal to or greater than the strength of standard Ottawa sand mortar.
 - d. Unless specified otherwise, fine aggregate shall meet the grading requirements of TxDOT Standard Specifications 421.2, Table 4.
 - e. Fine aggregate will be subjected to the Sand Equivalent Test (Test Method Tex-203-F). The sand equivalent value shall not be less than eighty (80), or less than the value shown on the plans, whichever is greater. The acid insoluble residue of fine aggregate used in concrete subject to direct traffic shall be not less than sixty percent (60%) by weight when tested in accordance with Test Method Tex 612-J.

5. Mixing Water

- a. Water for use in concrete and for curing shall be free from oil, acids, organic matter or other deleterious substances and shall not contain more than 1,000 parts per million of chlorides as Cl. nor more than 1,000 parts per million of sulfates as SO₄.
- b. Water from municipal supplies approved by the State Health Department will not require testing. Water from other sources will not be allowed. A sample of approximately one gallon will be submitted to Materials and Tests Division, Camp Hubbard, Austin, for test and approval.
- c. Tests procedure shall be in accordance with AASHTO Designation: T 26.

6. Joint Filler

- a. Boards for expansion joint filler and for contraction joints shall be of the size, shape and type indicated on the details.
- b. Boards shall be obtained from redwood timber. They shall be sound heartwood and shall be free from sapwood, knots, clustered birdseye, checks and splits. Occasional sound or hollow birdseye, when not in clusters, will be permitted provided the board is free from any other defects that will impair its usefulness as a joint filler.

7. Joint Sealing Material

- a. Unless otherwise shown on the plans, joint sealing material shall conform to the requirements herein or as an approved equivalent. The material shall adhere to the sides of the concrete joint or crack and shall form an effective seal against infiltration of water and incompressibles. Joints shall not be overfilled. The material shall not crack or break when exposed to low temperatures.
 - i. **Hot Poured Rubber:** This sealer shall be a rubber asphalt compound which when heated shall melt to the proper consistency for pouring and shall solidify on cooling at atmospheric temperatures.

The material when tested in accordance with Test Method Tex-525-C shall meet the following requirements:

Penetration:

32°F, 200 grams, 60 seconds.....not less than 0.28 cm
77°F, 150 grams, 5 seconds45 to 0.75 cm

Flow:

5 hours, 140°F, 75° incline..... not more than 0.5 cm

Bond and Extension:

15°F, 5 cycles There shall be no cracking of the joint sealing material or break in the bond between the joint material and the mortar pieces.

8. Asphalt Board

- a. Asphalt board when used in accordance with plans shall be of required size and uniform thickness and when used in transverse joints, shall conform approximately to the shape of the pavement crown as shown on plans. Asphalt board shall consist of two liners of 0.016-inch asphalt impregnated paper filled with a mastic mixture of asphalt and vegetable fiber and/or mineral filler.
- b. Boards shall be smooth, flat and straight throughout, and shall be sufficiently rigid to permit easy installation. Boards that crack or shatter during installing and finishing operations will not be acceptable. Board shall be furnished in lengths equal to one-half (1/2) the pavement width or in lengths equal to the width between longitudinal joints and may be furnished in strips or scored sheet of the required shape. When tested in accordance with Test Method Tex-524-C the asphalt board shall not deflect from the horizontal more than 3/4-inch in 3 1/2-inches.

9. Steel Dowel Bars

- a. Smooth steel bar dowels shall be of the size and type indicated on the details and shall be open-hearth, basic oxygen or electric-furnace steel conforming to the mechanical properties specified for grade 60 in ASTM Designations: A 615. The free end of dowel bars shall be smooth and free of shearing burrs.
- b. One end of each dowel bar shall be encased in an approved cap having an inside diameter of one 1/16-inch greater than the diameter of the dowel bar. The cap shall be of such strength, durability and design as to provide free movement of the dowel bar and shall be approved by the City prior to use. One end of the cap shall be lubricated in order to permit free movement of the dowel bar for a distance equivalent to one hundred fifty percent (150%) of the width of the expansion joint used. The dowel caps and dowel bars shall be held securely in place by an approved dowel support basket, or an approved equivalent thereof.

10. Steel Reinforcement

Reinforcing steel shall be in accordance with DMS-7320, Item 440, "Qualification Procedure for Reinforcing Steel Producing Mills".

11. Membrane Curing Compound

The membrane curing compound shall be in accordance with "Membrane Curing," Type 2 white pigmented.

C. EQUIPMENT: All equipment and tools necessary for handling materials and performing all parts of the work shall be approved by the City and shall conform to Item 360.4 "Equipment" of the latest TxDOT Specs.

D. PROPORTIONING CONCRETE:

1. Concrete Control

- a. The City shall furnish at its expense continuous plant control of the concrete by having full time a commercial laboratory at concrete plants to make the following test and inspection:
 - i. Check incoming aggregates, fine and coarse, for gradations, specific gravity, unit weight, abrasion wear, etc.
 - ii. Determine moisture contents of the aggregates to adjust bin weights to comply with designs.
 - iii. Make all concrete designs in accordance with Specifications.
 - iv. Check scales as needed for accuracy.
 - v. Help maintain proper slumps, as specified.
 - vi. Send inspection reports for each day's operations.
- b. The laboratory shall cast field specimens and perform related tests for every one hundred (100) cubic yards of concrete manufactured for main lane paving and, every fifty (50) cubic yards of concrete manufactured for hand placement or any portion thereof. (Rev. 8/2019)

2. Concrete Mix Design

- a. The concrete shall be composed of Normal Portland Cement or High-Early-Strength Portland Cement, coarse aggregate, fine aggregate and water. The coarse aggregate cannot be less than sixty percent (60%) of the total combination of aggregates by volume. High-Early-Strength Portland Cement may be used only when specifically approved by the City in writing and the concrete made therewith shall be subject to all applicable provisions of these specifications.
- b. Within a period of not less than ten (10) days prior to the start of concreting operations, the Contractor shall submit to the City a design of the concrete mix he proposes to use together with samples of all materials to be incorporated into the mix and a full description of the source of supply of each material component. The design of the concrete mix shall conform to the provisions and limitation requirements of these specifications. When the design mix has been approved by the City, there shall be no change or deviation from the proportions thereof or sources of supply except as hereinafter provided. No concrete may be placed on the job site until the mix design has been approved by the City.
- c. It is the intent of this specification to develop and use an economical mix design with the proportion of fine aggregate in the concrete mix near the upper limit of the range that permits proper placing, finishing, and texturing and which will fulfill all requirements of this specification when using acceptable materials as

furnished by the Contractor. Where hand finishing is permitted, the addition of one-half sack of cement (6 sacks total) per cubic yard shall be required.

- d. The concrete mix design shall have an entrained air content of four and a half percent (4.5%), +/- one and a half percent (1.5%).
 - e. After the mix proportions and water-cement ratio required to produce concrete of the specified strength have been determined, placing of the concrete may be started. The strength of the concrete in the completed pavement will be determined by compressive strength test specimens.
 - f. All concrete shall be designed for a minimum compressive strength at twenty-eight (28) days of thirty-six hundred pounds per square inch (3,600 psi) or a minimum flexural strength of five hundred seventy-five pounds per square inch (575 psi) at the age of seven (7) days when Type I Portland Cement is used. If Type III cement is used, a flexural strength at seven (7) days of six hundred pounds per square inch (600 psi) will be required. Flexural strength will be determined as a simple beam with center point loading (A.S.T.M. Designation C 293). While concreting operations are in progress, beam or cylinder specimens shall be made by the City's independent laboratory according to the STANDARD SPECIFICATIONS FOR PUBLIC WORKS AND TRANSPORTATION CONSTRUCTION AS ISSUED BY THE NORTH CENTRAL TEXAS COUNCIL OF GOVERNMENTS (NCTCOG). All concrete having a minimum compressive strength at twenty-eight (28) days of thirty-six hundred (3,600) psi shall have a minimum cement content of five and a half (5.5) sacks per cubic yard.
3. Workability:
- a. Concrete shall be uniformly plastic, cohesive and workable. Workable concrete is defined as concrete which can be placed without honeycomb and without voids in the surface of the pavement after the specified finishing machine has been over a given area twice. Workability shall be obtained without producing a condition such that free water appears on the surface of the slab when being finished as specified. Where water appears on the surface of the concrete after finishing and this condition cannot be corrected by reasonable adjustment in the batch design, the bleeding will be immediately corrected by one of the following measures or a combination of two or more of the following listed measures:
 - i. Redesign of the batch.
 - ii. Increase of cement content.
 - iii. Use of an approved admixture.
 - b. The mix will be designed with intention of producing concrete which will have a slump of 1½-inches when tested in accordance with the STANDARD SPECIFICATIONS FOR PUBLIC WORKS AND TRANSPORTATION CONSTRUCTION AS ISSUED BY THE NORTH CENTRAL TEXAS

COUNCIL OF GOVERNMENTS (NCTCOG). The maximum slumps shall be as follows.

- i. Machine placement – 4-inches maximum
- ii. Hand placement – 5-inches maximum

E. FORMS:

1. Placing and Removing Forms

- a. The subgrade under the forms shall be firm and cut true to grade so that each form section when placed will be firmly in contact for its whole length and base width, and exactly at the established grade. Any subgrade under the forms below established grade shall be corrected, using suitable materials, place, sprinkled and rolled as directed. Forms shall be staked with at least three pins for each 10-foot section. A pin shall be placed at each side of every joint. Form sections shall be tightly joined and keyed to prevent relative displacement. Forms shall be cleaned and oiled each time they are used. Forms shall be set for sufficient distance in advance of the point where concrete is being placed to permit a finished and approved subgrade length of not less than 300-feet ahead of the mixer. Conformity of the grade and alignment of forms shall be checked immediately prior to placing concrete, and all necessary corrections made by the Contractor. Where any form has been disturbed or any subgrade becomes unstable, the form shall be reset and rechecked.
- b. In exceptional cases, the City may require suitable stakes driven to the grade of the bottom of the forms to afford additional support. Sufficient stability of forms to support the equipment operated thereon and to withstand its vibration without springing or settlement shall be required. If forms settle and/or deflect over 1/8-inch under finishing operations, paving operations shall be stopped and the forms shall be reset to line and grade.
- c. Forms shall remain in place for not less than twelve (12) hours after the concrete has been placed. They shall be carefully removed in such a manner that no damage will be done to the edge of the pavement. Any damage resulting from this operation shall be immediately repaired. After the forms have been removed, the ends of all joints shall be cleaned, and any honeycombed areas shall be patched immediately with an approved mortar. In cases of severe honeycomb, the pavement will be removed.
- d. Immediately after patching, the form trench, if used, shall be filled immediately with earth from the shoulders in such a manner as to shed water from rainfall or curing away from the edge of the pavement. On completion of the required curing, the subgrade or shoulders adjacent to the pavement shall be placed in condition to maintain drainage.
- e. Any grade revisions shall be established by the City. No additional payment over the contract unit price will be made for any pavement of a thickness exceeding that required on the plans.

F. CONCRETE MIXING AND PLACING:

1. Mixing Methods

- a. The concrete shall be mixed in a mixer conforming to the requirements of the latest TxDOT Standard Specifications.
- b. Central Mix: The aggregates, cement and water shall be measured separately, introduced into the mixer, and mixed for a period of not less than fifty (50) seconds nor more than ninety (90) seconds, measured from the time the last aggregate enters the drum to the time discharge of the concrete begins. The required water shall be introduced into the mixing drum during the first fifteen (15) seconds of mixing. The entire contents of the drum shall be discharged before any materials of the succeeding batch are introduced.
- c. The City may increase the minimum mixing time to that necessary to produce thoroughly mixed concrete based on inspection or appropriate uniformity tests. The mixing time may be varied at any time as necessary to produce acceptable concrete.
- d. The concrete shall be discharged into the specified hauling equipment and delivered to the road site. If truck agitators are used, the concrete shall be continuously agitated at not less than one (1) nor more than six (6) rpm as directed by the City.
- e. The maximum size of the concrete batch, absolute volume, shall not exceed one hundred twenty percent (120%) of the rated size of the mixer (40.8 cubic feet maximum batch for the 34-cubic foot paver). Spilling of material from the mixer drum shall be corrected by reducing the size of the batch. Retempering or remixing of concrete will not be permitted.
- f. The initial batch of concrete mixed after each time the mixer is washed out shall be enriched by additional mortar. The additional mortar shall be one (1) sack of cement and three (3) parts sand.

2. Weather Conditions

- a. All weather temperatures will be based on readings forecasted by the National Oceanic and Atmospheric Administration (NOAA).
- b. Concrete shall not be placed until ambient temperature reaches thirty-five (35) degrees with a projected high of forty (40) degrees (minimum). Operations shall cease when temperature falls below forty (40) degrees. Temperature shall be taken in the shade and away from artificial heat.
- c. The Contractor shall be responsible for the quality and strength of concrete under cold weather conditions and any concrete damaged by freezing shall be removed and replaced at his/her expense.

3. Mixing Verification

Before unloading and prior to concrete placement, delivery tickets shall be furnished for the batch of concrete containing the information required for TxDOT Form 596. The City will verify all required information is provided on the delivery tickets and may suspend concrete operations until the corrective actions are implemented if the delivery tickets do not provide the required information.

4. Placing Concrete

- a. Moisture shall be applied to the subgrade prior to placement of concrete. Concrete shall be placed only on approved subgrade or subbase, and unless otherwise indicated on plans, the full width of the pavement shall be constructed monolithically. The concrete shall be rapidly deposited on the subgrade in successive batches and shall be distributed to the required depth and for the entire width of the pavement by shoveling or other approved methods. Workmen will not be permitted to walk in the concrete with any foreign material on their boots or shoes.
- b. The placing operation shall be continuous. At the end of the day, or in case of unavoidable interruption or delay of more than thirty (30) minutes, work shall terminate at the nearest regularly established joint.
- c. When the concrete is to be placed in separate lanes, the junction line shall not deviate from the true line more than ½-inch at any point and shall be finished as shown on plans.
- d. Concrete shall be distributed to such depth that when consolidated and finished, the slab thickness required by plans will be obtained at all points and the surface shall not, at any point, be below the established grade. Special care shall be exercised in placing and spading concrete against forms and at all joints to prevent the forming of honeycombs and voids.
- e. If a central mixer is used, the Contractor shall provide a system satisfactory to the City for determining that concrete delivered to the road meets the specified requirements for mixing and time of placing.

5. Time

- a. Concrete shall not be placed before the time of sunrise and shall not be placed later than shall permit the finishing of the pavement during sufficient natural light in accordance with NCTCOG Specification 303.5.5 below.

Temperature/Time Requirements		
Concrete Temp (At Point of Placement)	Max Time (No Retarding Agent) Minutes	Max Time ⁽¹⁾ (With Retarding Agent) Minutes
Non-Agitated Concrete		
All temperatures	30	45
Agitated Concrete		

Above 90F	45	75
Above 75F thru 90F	60	90
75F and Below	90	120

⁽¹⁾Normal dosage of retarder

- b. Any concrete not placed as herein prescribed within the time limits specified will be rejected.

6. Hot Weather Concrete Placing

- a. Concrete with a temperature of 85°F or higher will require a retarding agent admixture.
- b. The maximum temperature of concrete at the time of placement will not exceed 100°F. All concrete that exceeds this temperature will be rejected.
- c. It shall be the Contractor's and/or his/her supplier's responsibility to take steps to control the temperature below 100°F.

7. Reinforcing Steel and Joint Assemblies

- a. Reinforcement must be stored above the ground on platforms, skids, or other supports, and be protected from damage and deterioration. Reinforcement must be free from dirt, paint, grease, oil, and other foreign materials when placed in the work. Reinforcement shall be free from defects such as cracks and delamination. Rust, surface seams, surface irregularities, or mill scale will not be cause for rejection if the minimum cross-sectional area of a hand wire-brushed specimen meets the requirements for the size of steel specified.
- b. Stainless reinforcing steel shall not be in direct contact with uncoated reinforcing steel, nor with galvanized reinforcing steel. This does not apply to stainless steel wires and ties. Stainless reinforcing steel shall be stored separately off the ground on wooden supports.
- c. Lap-splice, weld-splice, or mechanically splice bars as shown on the plans. Additional splices not shown on the plans will require approval by the City. Splices not shown on the plans will be allowed in slabs no more than 15-inches in thickness, columns, walls, and parapets.
- d. Unless otherwise approved, bars shall not be spliced less than 30-feet in plan length. For bars extending 30-feet in plan length, the distance center-to-center of splices must be 30-feet minimum 1 splice length, with no more than 1 individual bar length less than 10-feet. Lap splices not shown on plans, but otherwise permitted shall be in accordance with the following table. The specified concrete cover and spacing at splices must be maintained the lap-spliced bars placed in contact, and securely tied together.

Minimum Lap Requirements for Steel Bar Sizes through No. 11

Bar Size Number (inches)	Uncoated Lap Length	Coated Lap Length
3	1 ft. 4 in.	2 ft. 0 in.
4	1 ft. 9 in.	2 ft. 8 in.
5	2 ft. 2 in.	3 ft. 3 in.
6	2 ft. 7 in.	3 ft. 11 in.
7	3 ft. 5 in.	5 ft. 2 in.
8	4 ft. 6 in.	6 ft. 9 in.
9	5 ft. 8 in.	8 ft. 6 in.
10	7 ft. 3 in.	10 ft. 11 in.
11	8 ft. 11 in.	13 ft. 5 in.

- Do not lap No. 14 or No. 18 bars.
 - Lap spiral steel at least 1 turn.
 - Splice WWR using a lap length that includes the overlap of at least two (2) cross wires plus 2-inches on each sheet or roll. Splices using bars that develop equivalent strength and are lapped in accordance with the above table will be allowed.
 - Lap the existing longitudinal bars with the new bars shown in the above table for box culvert extensions with less than 1-foot of fill. Lap at least 1-foot for extensions with more than 1-foot of fill.
 - Welded splices shall conform to the requirements of the plans and of TxDOT Item 448 “Structural Field Welding”. Field-prepare ends of reinforcing bars if they will be butt-welded. Delivered bars must be long enough to permit weld preparation.
 - Install mechanical coupling devices in accordance with the manufacturer’s recommendations at locations shown on the plans. Threaded male or female connections must be protected and the threaded connections cleaned when making the connection. Damaged or repaired threads will not be permitted.
 - Mechanical coupler alternate equivalent strength arrangements, to be accomplished by substituting larger sizes or more bars, will be considered if approved in writing before fabrication of the systems.
- e. All reinforcing steel, including tie bars, dowel bars, and dowel support baskets shall be accurately placed and secured in position in accordance with details shown on plans (use TxDOT latest approved Reinforcing Steel Mill List). Reinforcing bars shall be securely wired together at alternate intersections, following a pattern approved by the City, and at all splices, and shall be securely wired to each dowel intersected. Tie bars shall be installed in the required position by the method and device shown on plans or by approved method and device equivalent thereto. Bar coatings required by plans, and of material specified, shall be completed and the bars and coating shall be free of dirt or other foreign matter at the time of installation of the concrete.

- f. Tightly adhered scale or rust which resists removal by vigorous wire brushing need not be removed except that excessive loss of section to the reinforcement due to rust shall be cause for rejection. Excessive loss of section shall be defined as loss of section to the extent that the reinforcement will no longer meet the physical requirements for the size and grade of steel specified.
- g. Where plans require an assembly of parts of pavement joints, the assembly shall be completed, placed at required location and elevation, and all parts rigidly secured in required position by the method and devices shown on plans or by approved method and devices equivalent thereto. Dowel bars shall be accurately installed in joint assemblies in accordance with plans and details, each parallel to the pavement surface and to the center line of the pavement and shall be rigidly secured in required position by such means (as shown on plans, or approved equivalent thereto) that will prevent their displacement during placing and finishing of the concrete. Unless specifically authorized by the City in writing, the dowel support baskets, shall be accurately installed in joint assemblies in accordance with plans and details, each unit vertical with its length parallel to the center line of the pavement, and all units shall be rigidly secured in required position by such means (as shown on plans, or approved equivalent thereof) that will prevent their displacement during placing and finishing of the concrete. Header boards, joint filler and other material used for forming joints shall be accurately notched to receive each dowel support basket. All dowel support baskets shall be free of rust and clean when installed in the concrete.
- h. Pre-set L bars shall not be straightened in new concrete before three (3) days of cure. Drilling for dowel or rebar installation shall not take place before three (3) days of cure on new concrete.

8. Construction Joints

- a. Intentional stoppage of the concrete placement shall be at either an expansion joint or at a weakened plane joint. The following provisions shall govern for each type of joint at which the concrete placement is stopped.
 - i. When the concrete placement is stopped at an expansion joint, the complete joint assembly shall be installed and rigidly secured in required position as shown on plans. A bulkhead of sufficient cross-sectional area to prevent deflection, accurately notched to receive the dowel support baskets or dowels and shaped accurately to the cross-section of the pavement shall be provided and installed as a back-up for the joint filler and rigidly secured in required position to permit accurate finishing of the concrete up to the joint. After the concrete has been finished to the joint, formation of the joint shall be executed as specified herein and in accordance with plan requirements. The back-up bulkhead shall remain in place until immediately prior to the time when concrete placing is resumed, when it shall be carefully removed in such manner that no element of the joint assembly will be disturbed. The exposed portion of

the joint assembly shall be free to adhere to concrete, dirt or other material at the time concrete placement is resumed.

- b. When concrete placement is stopped at a weakened plane joint, all applicable provisions of paragraph (a) above shall apply in addition to the following requirements:
 - i. The Contractor shall have available a bulkhead shaped to the section of the pavement. This bulkhead must be drilled to permit the continuation of all longitudinal reinforcing steel through the construction joint and shall be of sufficient section and strength to prevent deflection.
 - ii. Immediately upon the unintended stoppage of the concrete placement, the Contractor shall place the available concrete to a line and install the above described bulkhead at right angles to the centerline of the pavement, perpendicular to the surface and at the required elevation. Concrete shall be placed and finished to this bulkhead. Any concrete remaining on the subgrade ahead shall be removed and disposed of as directed. When concrete placement is resumed before the concrete has set to the extent that the concrete will stand on removal of the bulkhead, the new concrete shall be vibrated with the first. An edge created by a construction joint of this type shall have a tooled joint and shall be sealed as required for contraction joints.

G. JOINTS:

1. General

- a. All transverse and longitudinal joints when required in the pavement shall be of the type or alternate type shown on plans and shall be constructed at required location, on required alignment, in required relationship to tie bars and joint assemblies, and in accordance with details shown on the plans. Such stakes, braces, brackets or other devices shall be used as necessary to keep the entire joint assembly in true vertical and horizontal position.
- b. Joints shall be installed as shown on the plans. A rigid transverse bulkhead, for the reinforcing steel, shall be installed and shaped accurately to the cross-section of the pavement when concrete placement is stopped. (Rev 2/2020)
- c. Careful workmanship shall be exercised in the construction of all joints, to ensure that the concrete sections are completely separated by an open joint or by the joint materials and to ensure that the joints will be true to the outline indicated.

2. Expansion Joints

Transverse expansion joints shall be formed perpendicular to the centerline and surface of the pavement and shall be constructed in accordance with the sequence of operations shown on plans. After the transverse finishing machine and before the longitudinal finishing machine have passed over the joint, the Contractor shall test

the joint filler for correctness of position and make any required adjustment in position of the filler and shall install the tooled joint form in accordance with plans. After removal of the joint seal form as required by plans, the tooled joint above the joint filler shall be thoroughly sandblasted or machine routed to remove all projecting concrete, laitance, dirt or foreign matter. The concrete faces of the tooled joint shall be left true to line and section throughout the entire length of the joint. On completion of curing of the pavement, the joint sealing filler of the type specified shall be placed in accordance with plans. The faces of the tooled joint shall be clean and surface dry at the time joint sealing filler is placed. On completion of the joint seal, the pavement adjacent to the joint shall be left free of joint sealing material. The tooled joint shall be exactly above and not narrower than the joint filler with no concrete over hangings.

3. Weakened Plane Joints

- a. Weakened plane joints shall consist of transverse contraction joints and longitudinal joints and shall be sawed as specified on the plans. The saw shall be power driven, shall be manufactured especially for the purpose of sawing concrete, and shall be capable of performing the work. Saw blades shall be designed to make a clean smooth cut having a width and depth of cut as detailed on the plans. Tracks adequately anchored, chalk, string line or other approved methods shall be used to provide true alignment of the joints. The concrete saw shall be maintained in good operating condition and the Contractor shall keep a stand-by power saw on the project at all times when concrete operations are under way. No concrete shall be sawed without the use of water.
- b. If membrane curing is used, the portion of the seal which has been disturbed by sawing operations shall be restored by the Contractor by spraying the areas with additional curing seal.
 - i. Contraction joints: Transverse contraction joints shall be sawed joints perpendicular to the centerline and the surface of the pavement and shall be constructed by the method, and in sequence of operations, as shown on plans. Where sawed joints are used, contraction joints at intervals shown on the plans shall be sawed as soon as sawing can be accomplished without damage to the pavement and before twenty-four (24) hours after the concrete has been placed. The remaining contraction joints shall be sawed in a uniform pattern as directed by the City, and they shall be completed before uncontrolled cracking of the pavement takes place. All joints shall be completed before placing concrete in succeeding lanes and before permitting traffic to use the pavement.
 - ii. Longitudinal Joints: Longitudinal joints shall be of the type or alternate types shown on plans and shall be constructed of specified materials in accordance with provisions of the plans. Longitudinal joints shall be constructed accurately to required lines, shall be perpendicular to the pavement surface at the joint, and the pavement surface over and adjacent to the joint shall be finished as specified.

Longitudinal joints shall be sawed as soon as sawing can be accomplished without damage to the pavement and before twenty-four (24) hours after the concrete has been placed, the exact time to be approved by the City. Sawing shall not cause damage to the pavement and the groove shall be cut with a minimum of spalling.

4. Joint Sealers

- a. Joint sealants will not be required on concrete pavement that is to be overlaid with asphaltic materials. Excessive spalling of the joint saw groove shall be repaired using an approved method before installing the sealant. All joints shall be sealed before opening the pavement to all traffic. (Rev. 2/2020)
- b. Prior to sealing, joints shall be routed to the proper depth. Joints shall be cleaned and sealed in accordance with TxDOT Item 438 "Cleaning and Sealing Joints". All slurry waste shall be removed immediately. All joints shall be sealed no sooner than seven (7) days and no later than twenty-eight (28) days from time of placement, unless otherwise directed by the City. (Rev. 2/2020)
- c. Hot Poured Rubber: This material shall be melted in an approved oil-bath kettle equipped with temperature indicators and continuously operated mechanical agitators. The material shall not be heated above 450°F and any material heated above that temperature will be rejected.

5. Asphalt Board

Asphalt expansion materials, wherever used, shall be anchored to the concrete on one side of the joint by means of copper wire or nails not lighter than No. 12 B & S gage. Such anchorage shall be sufficient to overcome the tendency of the material to fall out of the joint.

6. Curbs

- a. The curb shall be constructed in lengths equal to the adjoining pavement slab lengths, and expansion joints shall be provided in the curb opposite each transverse expansion joint in the pavement. Expansion joint material shall be of the same thickness, as specified for the pavement and shall be of the section as shown for the curb. All expansion joints shall be carried through the curb.
- b. Transverse contraction joints shall be sawed across the curb at the same location and at the same time as sawing of the transverse contraction joints in the pavement are sawed.

H. SPREADING AND FINISHING:

1. Machine Finishing

- a. All concrete pavement shall be finished mechanically with approved power-driven machines, except as herein provided. Hand finishing will be permitted on the transition from a crowned section to a super-elevated section without crown on curves, and on straight line super-elevation sections less than 100-feet in length. Hand finishing will also be permitted on that portion of a widened

pavement outside the normal pavement width, on sections where the pavement width is not uniform, or required monolithic widths are greater than that of available finishing machines.

- b. Machine finishing of pavement shall include the use of power-driven spreaders, power-driven vibrators, power-driven transverse strike-off, and screed, or such alternate equipment as may be substituted and approved under the latest TxDOT Standard Specifications. Further, any machine finishing equipment that rides on previously placed forms will be prohibited on any roadway with a total width of more than 28-feet, nor will they be allowed on any divided roadway of any width.
- c. All concrete pavement shall be consolidated by a mechanical vibrator. As soon as the concrete has been spread between the forms, the approved mechanical vibrator shall be operated to consolidate the concrete and remove all voids. Hand manipulated vibrators shall be used for areas not covered by the mechanical vibratory unit. A wet Burlap Drag will be required on all machine paving.
- d. Concrete shall be of a consistency that allows completion of all finishing operations without addition of water to the surface. Minimal amount of water fog mist may be used to maintain a moist surface. If float or straightedge operations result in excess slurry, fogging shall be reduced.
- e. After finishing is complete and the concrete is still workable, the surface shall be tested for trueness with an approved 10-foot steel straightedge. The straightedge shall be operated from the side of the pavement, placed parallel to the pavement centerline and passed across the slab to reveal any high spots or depressions. Straightedge operations shall begin with twenty-five percent (25%) of straightedge on new concrete and seventy-five percent (75%) on the existing concrete, advancing to no more than half its length. Practically perfect contact of the straightedge with the surface will be required, and the pavement shall be leveled to this condition, in order to ensure conformity with the surface test required below after the pavement has fully hardened. Any correction of the surface required shall be accomplished by adding concrete, if required, and by operating the longitudinal float over the area. The surface test with the straightedge shall then be repeated.
- f. For one-lane pavement placement and uniform widening, the equipment for machine finishing of concrete pavement shall be as directed by the City but shall not exceed the requirements of these specifications.
- g. After completion of the straightedge operation, the first pass of the baker broom shall be made as soon as construction operations permit and before the water sheen has disappeared from the surface. This shall be followed by as many passes as required to produce the desired uniform texture depth satisfactory to

the City. There shall be no unnecessary delays between passes. The baker broom shall be free from encrusted mortar.

2. Hand Finishing

- a. Hand finishing will only be permitted with prior authorization from the City. Six sacks of cement per cubic yard shall be required for all hand finish concrete.
- b. When hand finishing is permitted, the concrete shall be struck off with an approved strike-off screed to such elevation that when consolidated and finished the surface of the pavement shall conform to the required section and grade.

3. Surface Testing

After the concrete has been placed twelve (12) hours or more, if necessary the City may test the surface of the pavement with a 10-foot straightedge. The surface shall not vary from the straightedge by more than 1/8-inch between any two (2) contacts, when measured longitudinally or transversely. Any high spots causing a departure from the straightedge in excess of that specified shall be ground down by the Contractor to meet the surface test requirements. Where the texture of the pavement is removed by extensive grinding, the texture shall be restored by grooving the concrete to meet the surface finishing requirements.

I. CURING:

1. All concrete pavement shall be cured by protecting it against loss of moisture for a period of not less than seventy-two (72) hours from the beginning of curing operations. After finishing operations have been completed and immediately after the water shown has dissipated from the surface, the entire surface of the newly laid concrete shall be covered and cured in accordance with the requirements specified. Failure to provide sufficient cover material or failure to maintain saturation in wet curing methods, lack of water to adequately take care of both curing and other requirements, or other failures to comply with curing requirements shall be cause for immediate suspension of concreting operations and removal of any sections which are improperly cured.
2. The covering material used in curing shall be removed as necessary to saw joints or to comply with the requirements for "Surface Test." The concrete surface shall be maintained wet with a water spray, if required, and the covering material replaced immediately on completion of sawing and testing and any required surface correction.

J. PROTECTION OF PAVEMENT AND OPENING TO TRAFFIC:

1. Weather Conditions

Contractor shall monitor the weather and be aware that paving that is rained upon is no longer compliant with specifications and must be removed and replaced at Contractor's expense. No topping of any kind will be allowed to serve as a riding surface. No concrete will be allowed to stay in place when:

- Water/cement ratio has been exceeded
- Curing compound has been placed on it and the subsequently finished

- Concrete has been covered with plastic for so long that normal finishing activities cannot provide the proper finish for the pavement surface

2. Protection of Pavement

- a. The Contractor shall erect and maintain the barricades required by plans and such other standard and approved devices as will exclude public traffic and traffic of his/her employees and agents from the newly placed pavement for the periods of time hereinafter prescribed. Portions of the roadway, or crossings of the roadbed required to be maintained open for use by traffic, shall not be obstructed by the above required barricades. Crossings of the pavement required by plans, or by construction sequence, during the period prior to opening to traffic as herein specified, shall be provided with an adequate and substantial bridge, approved by the City.
- b. It shall be the responsibility of the Contractor to protect concrete finish from any type of damage. Any concrete finish that has been damaged will be removed and replaced at the Contractor's expense.

3. Opening Pavement to Traffic

- a. The pavement shall be closed to all traffic, including vehicles of the Contractor, until the concrete is at least seven (7) days old but not before concrete has achieved seventy percent (70%) of design strength. This period of closure to all traffic may be extended if, in the opinion of the City, weather or other conditions make it advisable to provide an extension of the time of protection.
- b. At the end of the seven (7) day period and as long thereafter as determined by the City, the pavement may be opened for use by vehicles of the Contractor provided the gross weight (vehicle plus load) of such vehicles does not exceed fourteen thousand (14,000) pounds. Such opening, however, shall in no manner relieve the Contractor from his/her responsibility for the work. On the sections of the pavement that will be opened to traffic, all joints shall first be sealed, the pavement cleaned and soil placed against the pavement edges. This seven (7) day policy shall also apply to other types of operations, such as sealing, backfill, etc., where traffic movements could affect results of the work performed.
- c. After the concrete in any section is fourteen (14) days old, or as long thereafter as determined by the City, such section of pavement may be opened to all traffic as required by plans or when all other required work, as directed by City, has been performed for safety purposes.
- d. When High Early Strength Concrete resulting from the use of Type III cement as required by plans or special provisions is used, the pavement may be opened to all traffic after the concrete is seven (7) days old, or as long thereafter as deemed necessary by the City, subject to the same provisions governing the opening after fourteen (14) days as above prescribed.

- e. Where the Contractor desires to move any equipment not licensed for operation on public highways, on or across any pavement opened to traffic, he shall protect the pavement from all damage.

4. Emergency Opening to Traffic

- a. The City may require the opening of pavement to traffic prior to the minimum time specified above under conditions of emergency which in his/her opinion require such action in the interest of the public. In no case, shall the City order the opening of the pavement to traffic within less than seventy-two (72) hours after the last concrete in the section is place.
- b. The Contractor shall remove all obstructing materials, place soil against the pavement edges and perform other work involved in providing for the safety of traffic as required by the City in ordering emergency opening. Orders for emergency opening of the pavement to traffic will be issued by the City in writing.

K. PENALTY FOR DEFICIENT PAVEMENT THICKNESS:

- 1. Refer to The North Texas Council of Governments (NCTCOG) Specification 303.8.2.
- 2. No additional payment over the contract unit price will be made for any pavement of a thickness exceeding that required by the plans.

L. MEASUREMENT: When provided by plans and PROPOSAL, concrete pavement will be measured by the square yard of the surface area of completed and accepted work. The measurement shall include the portion of the pavement slab extending beneath the curb. When concrete pavement is to be measured by the square yard and monolithic curb is required, monolithic curb will be subsidiary to the item for reinforced concrete pavement.

M. PAYMENT:

- 1. The work performed and materials furnished as prescribed by this item and measured as provided under "Measurement" will be paid for at the unit price bid for Reinforced Concrete pavement, or the adjusted unit price for pavement for deficient thickness as provided under "Penalty for Deficient Pavement Thickness," which price shall be full compensation for shaping and fine grading the roadbed, including furnishing and applying all water required; for furnishing, loading and unloading, storing, hauling and handling all concrete ingredients, including all freight and royalty involved; for placing and adjusting forms, including supporting material or preparing track grade; for mixing, placing, finishing, sawing, cleaning and sealing joints, and curing all concrete; for furnishing and installing all reinforcing steel; for furnishing all materials for sealing joints and placing longitudinal, expansion and weakened plane joints, including all steel dowel caps and dowel support baskets required, and wire and devices for placing, holding and supporting the steel bars, dowel support baskets and joint filler material in proper position, for coating steel bars where required by plans, and for manipulations, labor, equipment, appliances, tools, traffic provisions and incidentals necessary to complete the work.

2. Excavation required by this item in the preparation of the subgrade and for the completion of the shoulders and slopes will be measured and paid for in accordance with the provisions governing the Items of "Unclassified Roadway Excavation."
3. Sprinkling and rolling required for the compaction of the rough subgrade in advance of fine grading will be measured and paid for as indicated in the governing items of excavation. Maintenance of a moist condition of the subgrade in advance of fine grading and concrete placing will not be paid for directly but shall be considered subsidiary work, as provided above.

13-17 CONCRETE MEDIANS:

- A. All concrete for concrete medians and median noses shall have a minimum thickness of 12-inches. Reinforcement shall be No. 4 bars on 18-inches centers both ways or as shown on the plans. All Class "C" concrete shall have a minimum cement content of five and a half (5.5) sacks per cubic yard and a minimum compressive strength at twenty-eight (28) days of thirty-six hundred (3,600) pounds per square inch. All concrete shall be vibrated. Measurement and payment is included in the Reinforced Concrete Pavement pay item.
(Rev. 9/2019)
- B. Redwood expansion joints shall be placed at the end of the monolithic nose radius and at every 40-feet. Curing shall be in accordance with Special Project Specification Section 13-18 "Membrane Curing." Curing and reinforcement shall be considered subsidiary to the various bid items.

13-18 MEMBRANE CURING:

- A. DESCRIPTION:
This item shall consist of curing concrete pavement, curbs, gutters, sidewalks, driveways, medians, islands, concrete channel/slope, concrete structures, and other concrete as indicated on the plans by impervious membrane method.
- B. MATERIALS:
 1. The membrane curing compound shall comply with the "Standard Specification for Liquid Membrane-forming Compounds for Curing Concrete," ASTM Designation: C 309, Type 1 clear or translucent, or Type 2 white pigmented. The material shall have a minimum flash point of 80°F when tested by the "Pensky-Martin Closed Cup Method."
 2. It shall be of such consistency that it can be satisfactorily applied as a fine mist through an atomizing nozzle by means of approved pressure spraying equipment at atmospheric temperatures above 40°F.
 3. It shall be of such nature that it will not produce permanent discoloration of concrete surfaces nor react deleteriously with the concrete or its components. Type 1 compound shall contain a fugitive dye that will be distinctly visible not less than four (4) hours nor more than seven (7) days after application.

4. The compound shall produce a firm, continuous, uniform moisture impermeable film free from pinholes and shall adhere satisfactorily to the surfaces of damp concrete. It shall, when applied to the damp concrete surface, at the rate of coverage specified herein, dry to touch in not more than four (4) hours and shall adhere in a tenacious film without running off or appreciably sagging. It shall not disintegrate, check peel or crack during the required curing period.
5. The compound shall not peel or pick up under traffic and shall disappear from the surface of the concrete by gradual disintegration.
6. The compound shall be delivered to the job only in the manufacturer's original containers, which shall be clearly labeled with the manufacturer's name, the trade name of the material, and a batch number or symbol with which test samples may be correlated.
7. The water retention test shall be in accordance with Test Method Tex-219-F. Percentage loss shall be defined as the water lost after the application of the curing material was applied. The permissible percentage moisture loss (at the rate of coverage specified herein) shall not exceed the following:

24 hours after application.....2 percent
 72 hours after application.....4 percent

C. CONSTRUCTION METHODS:

1. The membrane curing compound shall be applied after the surface finishing has been completed, and immediately after the free surface moisture has disappeared. The surface shall be sealed with a single uniform coating of the specified type of curing compound applied at the rate of coverage recommended by the manufacturer and directed by the City, but not less than one (1) gallon per one hundred eighty (180) square feet of area. The Contractor shall provide satisfactory means and facilities to properly control and check the rate of applications of the compound.
2. The compound shall be thoroughly agitated during its use and shall be applied by means of approved power pressure sprayers. The sprayers shall be equipped with satisfactory atomizing nozzles. Only on small miscellaneous items will the Contractor be permitted to use hand-powered spray equipment.
3. The compounds shall not be applied to a dry surface and if the surface of the concrete has become dry, it shall be thoroughly moistened prior to application of membrane by fogging or mist application. Sprinkling or coarse spraying will not be allowed.
4. At locations where the coating shows discontinuities, pinholes, or other defects; or if rain falls on the newly-coated surface before the film has dried sufficiently to resist damage, an additional coat of the compound shall be applied immediately at the same rate of coverage specified herein.

5. To ensure proper coverage, the City shall inspect all treated areas after application of the compound for the period of time designated in the governing specification for curing, either for membrane curing or for other methods. Dry areas are identifiable because of the lighter color or dry concrete as compared to damp concrete. All suspected areas shall be tested by placing a few drops of water on the suspected areas. If the water stands in rounded beads or small pools which can be blown along the surface of the concrete without wetting the surface, the water-impervious film is present. If the water wets the surface of the concrete as determined by obvious darkening of the surface, or by visible soaking into the surface, no water-impervious film is present. Should the foregoing test indicate that any area during the curing period is not protected by the required water-impervious film, an additional coat or coats of compound shall be applied immediately, and the rate of application of the membrane compound shall be increased until all areas are uniformly covered by the required water-impervious film.
6. When temperatures warrant protection against freezing, curing by this method shall be supplemented with an approved insulating material capable of protecting the concrete for the specified curing period.
7. If at any time there is reason to believe that this method of curing is unsatisfactory or is detrimental to the work, the Contractor shall immediately cease the use of this method and shall change to curing by one of the other methods specified under this contract.

D. MEASUREMENT AND PAYMENT:

Work and materials prescribed herein will not be paid for directly but shall be included in the unit price bid for the items of construction in which these materials are used.

13-19 ASPHALTIC PRIME COAT: A prime coat shall be used on the stabilized base material immediately after the base material has been compacted to specified density and cut to grade. The prime coat shall be a liquid asphalt complying with the specification of the Asphalt Institute for type MS-2 Emulsified Asphalt. The prime coat shall be applied to the surface of the base at a rate of 0.20 to 0.40 gallons per square yard of surface and allowed to penetrate as far as possible. The cost of furnishing and installing the asphalt prime coat shall be considered subsidiary to the unit prices bid for subgrade.

13-20 TACK COAT: The unit bid prices for coarse graded base course and fine graded surface course shall include the application of a tack coat to each layer of asphaltic concrete before the next layer is applied and a tack coat shall also be applied to any exposed concrete edges that shall abuts any hot mix asphaltic concrete. The tack coat shall be a liquid asphalt complying with the specifications of the Asphalt Institute for SS-1h, MS-2 Emulsified Asphalt. The tack coat shall be applied to each layer at a rate not to exceed 0.05 gallons per square yard of surface.

13-21 NON-TRACKING TACK COAT: The unit bid prices for coarse graded base course and fine graded surface course shall include the application of a non-tracking tack coat to each layer of asphaltic concrete before the next layer is applied and a non-tracking tack coat shall also be applied to any exposed concrete edges that shall abuts any hot mix asphaltic concrete. The non-

tracking tack coat shall be applied to each layer at a rate not to exceed 0.05 gallons per square yard of surface.

Non-Tracking Tack Coat Emulsion

Property	Test Procedure	Quick Setting	
		QS-1HH	
		Min	Max
Viscosity, Saybolt Furol, 77° F, sec	T 72	15	--
Storage stability, 1 Day, %	T 59	--	1
Settlement, 5-day, %	T 59	2	5
Sieve test, %	T 59	--	0.30
Distillation test: ¹	T 59		
Residue by distillation, % by wt.		50	--
Oil distillate, by volume of emulsion		--	1.0
Test on residue from distillation:			
Penetration, 77°F, 100 g, 5 sec.	T 49	--	20
Solubility in trichloroethylene, %	T 44	97.5	--
Softening point, °F	T 53	150	
Dynamic shear, G*/sin(δ), 82°C, 10 rad/s, kPa	T 315	1.0	--

1. Exception to AASHTO T-59: Bring the temperature on the lower thermometer slowly to 350°F +/- 10°F. Maintain at this temperature for 20 min. Complete total distillation in 60 +/- 5 min. from first application of heat.

13-22 HOT MIX ASPHALTIC CONCRETE:

A. PLACEMENT:

HMAC cannot be laid until ambient temperature reaches forty (40) degrees with a projected high of fifty (50) degrees (minimum). Operations shall cease when temperature falls below fifty (50) degrees.

B. PAVING MIXTURES:

1. Mixture Design

Mixture shall be in accordance with TxDOT Standard Specification, Item 340.

2. Stability and Density

The mixture shall be designed to produce an acceptable mixture within tolerance, at or near optimum density. The mixture molded in the laboratory in accordance with TXDOT Test Method Tex-206-F and the bulk specific gravity of the laboratory compacted mixture determined in accordance with TXDOT Test Method Tex-207-F should have the following percent of maximum theoretical density as measured by TXDOT Test Method Tex-227-F and stability conforming to TXDOT Test Method Tex-208-F:

Optimum Density Range
95 to 97 Percent

Stability, Percent
Not Less than 42

3. Sampling and Testing for Field Control

Extraction tests for bitumen content and aggregate gradation shall be made for each five hundred (500) tons produced or fraction thereof. Extraction tests shall conform

to TXDOT Test Method Tex-210-F. Tests for stability of the asphalt mixture shall conform to TXDOT Test Method Tex-208-F. The mixture shall not vary from the grading proportions of the aggregate and the asphalt content by more than the respective tolerances and shall be within the limits specified for master grading.

4. Recycled Asphalt Pavement (RAP)

All RAP Material must meet TxDOT item number 340. Do not exceed fifteen percent (15%) RAP by weight in Type “B” mixtures; or five percent (5%) RAP by weight in Type “D” mixtures.

5. Recycled Asphalt Shingles (RAS): No RAS will be allowed in any mixtures.

C. IN-PLACE COMPACTION CONTROL:

1. In-place compaction control is required for all mixtures.

a. Asphaltic concrete should be laid and compacted to contain no more than eight percent (8%) nor less than three percent (3%) air voids unless otherwise indicated. The percent air voids will be calculated using the maximum theoretical specific gravity of the mixture determined according to TXDOT Test Method Tex-227-F. Roadway specimen, which shall either be cores or sections of asphalt pavement, will be tested according to TXDOT Test Method Tex-207-F. The same specimen shall be used for determining both the maximum theoretical density and field density. Specimens used for field density determinations shall be carefully crumbled, using heat, if necessary, and the maximum theoretical density determined as specified. If heating is necessary, the specimen shall be heated to the lowest temperature required for proper preparation of the sample. The use of nuclear field density determinations shall not be accepted as the basis for acceptance with respect to density. However, an approved nuclear gauge may be used to establish a rolling pattern.

b. The Contractor shall be responsible for assuring that the compaction of the asphaltic concrete being laid will attain between three (3) and eight (8) percent air voids. The Contractor's responsibility for the required compaction includes the selection of rolling equipment and the selection of rolling patterns to achieve the required compaction within the guidelines provided herein. The above selections of equipment and procedures must provide the required qualities of profile, smooth riding surface, and consistent workmanship in appearance.

2. Initial testing will be the responsibility of the City. Any retest will be the responsibility of the Contractor. Additional information is provided in Section 11-20 Quality Assurance/Quality Control (QA/QC).

D. ASPHALT TRANSITIONS:

Transitional asphalt shall have a minimum thickness of 4-inches Type “B” HMAC and 2-inches Type “D” HMAC or shall match existing pavement thickness, whichever is greater. Transition width shall be a minimum 2-feet for temporary and a minimum of 4-feet for

permanent with 8-inches CTB. Unless a separate item is included in the PROPOSAL, asphalt transition shall be subsidiary.

13-23 PAVING FABRIC (PETRO-MAT): Paving fabric shall be Skaps GC140, Petro-mat 4598, or approved equal. Contractor shall follow manufacturer's installation procedure. Petromat cannot be installed until ambient temperature is forty (40) degrees and rising. Item shall include cost of fabric, tack coat materials, and labor necessary to install the paving fabric.

13-24 STEEL GUARD RAIL: For this project, the steel guard rail shall be "Galvanized Steel Beam Guard Fence" conforming to the details shown on the plans and to the requirements of Item 560, "Metal Beam Guard Fence," of the latest TxDOT Standard Specifications.

13-25 GPS MONUMENT:

- A. Contractor shall Furnish and Install two (2) Berntsen Top Security Rod Monuments with logo # 200016 or two (2) Berntsen C35D - 3 1/2" Aluminum concrete markers with E logo #E432 or any combination of both (at the City Surveyor's discretion) complete and in place. Location of said Monuments/Markers shall be marked by the City Surveyor. Contractor shall notify the City Surveyor two (2) weeks before planned installation date.
- B. Contractor shall have a Registered Professional Land Surveyor survey the Berntsen Monuments/Markers, publish and certify GPS data sheets that meet and/or exceed Second Order Specifications using the Global Positioning System (GPS). Data Sheet horizontal coordinates shall be NAD 83 (2007 Adjustment) or be based on the latest adjustment of the City's GPS Monument Manual (located on Public Works & Transportation's web page). Please specify which adjusted datum is used for the project. Data Sheet vertical datum for the Berntsen Monuments/Markers shall be based on NAVD88 derived from calculating by applying vertical shifts derived from Geoid model 2012A or Geoid model 2003 or Geoid model 2009 to ellipsoid heights calculated from GPS/GNSS observations referenced to the North American Datum of 1983 (2007) or later datum or meet and/or exceed Third Order Specifications using conventional leveling methods.
- C. Contractor shall notify City Surveyor beforehand of exact date of installation of Berntsen Monuments/Markers so City Surveyor can inspect procedures of the installation of Berntsen Monuments/Markers.

13-26 TEMPORARY BATCH PLANT:

- A. If the Contractor chooses to construct a temporary batch plant, the following conditions (at a minimum) must be satisfied prior to approval from the City.
 - a. Batch plant must be permitted by the City. A copy of Notice of Intent (NOI) and approved Storm Water Pollution Prevention Plan must be on the premises.
 - b. Location map must be provided indicating routes for raw material delivery.
 - c. Location map must be provided indicating that the nearest recreational area, school, or residence is located at least 300-feet away.

- d. Letter of Permission must be provided by the City of the property (on which the batch plant is to be constructed) requiring that the Contractor leaves the site in as good or better condition.
 - e. The start and stop dates for operation of the plant must be provided.
 - f. It must be stated that the batch plant will be used to provide concrete for no other project(s) without written approval from the City.
- B. No additional pay will be made for the temporary batch plant.

END OF SECTION

SECTION NO. 14

SPECIAL PROVISIONS – WATER AND SANITARY SEWER SPECIFICATIONS

NUMERICAL LISTING

Section No.	
14-01	POLY-VINYL CHLORIDE (PVC) WATER PIPE AND FITTINGS
14-02	EMBEDMENT REQUIREMENTS FOR WATER PIPE & FITTINGS
14-03	THRUST BLOCKINGS
14-04	VALVE OPERATIONS NOTIFICATION
14-05	INTERRUPTION OF WATER SERVICE
14-06	CLEANING OF NEW WATER MAIN
14-07	FIRE HYDRANTS
14-08	RELOCATION OF EXISTING FIRE HYDRANTS
14-09	REMOVE/SALVAGE EXISTING FIRE HYDRANTS
14-10	GATE VALVES
14-11	WATER SERVICES
14-12	WATER METER REPLACEMENT
14-13	WATER METER RELOCATION OR ADJUSTMENT
14-14	WATER METER BOX REPLACEMENT
14-15	ABANDONING EXISTING VALVE BOX AND MANHOLE
14-16	POLY-VINYL CHLORIDE (PVC) SANITARY SEWER PIPE & FITTINGS
14-17	EMBEDMENT REQUIREMENTS FOR SANITARY SEWER PIPE & FITTINGS
14-18	LOW PRESSURE AIR TEST OF SANITARY SEWER LINES
14-19	DEFLECTION TESTING OF FLEXIBLE SANITARY SEWER
14-20	SANITARY SEWER SERVICE
14-21	BYPASS PUMPING
14-22	CAST-IN-PLACE MANHOLES
14-23	CCTV INSPECTION OF SANITARY SEWER MAINS
14-24	DISPOSAL OF EXCESS MATERIAL
14-25	PIPE HANDLING
14-26	TYING INTO EXISTING LINES
14-27	PLUGGING EXISTING LINES TO BE ABANDONED
14-28	DUCTILE IRON PIPE
14-29	DUCTILE IRON FITTINGS
14-30	GPS DATA ON WATER & SANITARY SEWER INSTALLATION
14-31	WORK ON THE EXISTING 33-INCH AND 27-INCH WATER MAINS

SECTION NO. 14

SPECIAL PROVISIONS – WATER AND SANITARY SEWER SPECIFICATIONS

Water and Sanitary Sewer improvements shall be in accordance with the latest version of the CITY OF ARLINGTON STANDARD SPECIFICATIONS FOR WATER & SANITARY SEWER CONSTRUCTION located at the City's web page,

https://www.arlingtontx.gov/city_hall/departments/public_works_transportation/engineering/standard_specifications_special_provisions, hereinafter referred to as "Standard Specifications".

References in parentheses located in the heading of each section below correspond to sections of the Standard Specifications.

(Rev. 4/2019)

14-01 POLY-VINYL CHLORIDE (PVC) WATER PIPE & FITTINGS (B 4A and B 4B): The poly-vinyl chloride (PVC) water pipe 4-inch through 60-inch shall in all respects comply with the latest revision of AWWA C900-16 (DR 18) Pressure Class 235 psi. All fittings shall be mechanical joint ductile iron fittings with polyethylene encasement.

(Rev 11-2018)

14-02 EMBEDMENT REQUIREMENTS FOR WATER PIPE & FITTINGS (B 19 & C 3.14): Unless otherwise specified, all water pipes shall be in accordance with Class "C" embedment detail.

14-03 THRUST BLOCKINGS (C 4.11 and C 6.10):

- A. Thrust blocking shall be placed at fire hydrants, valves, tapping sleeves, bends, tees, wyes, crosses, plugs and bends of five (5) degree or greater in the main water line. Each block, except those for upward thrusts, shall be placed so as to rest against firm undisturbed foundation of trench bottom. The supporting area shall be sufficient to withstand the thrust, including water hammer which may develop. All concrete used for thrust blocking shall conform to the section "Thrust Blocking" of the Standard Specifications. This is not a separate pay item but will be considered subsidiary to the various bid items.
- B. Blocking at bends shall be computed based upon pipe thrust at bends, or tees, with internal pressure of one hundred fifty (150) psi. Where upward thrusts are to be blocked, the thrust blocking shall be of sufficient weight to resist the thrust and the concrete shall be reinforced as directed by the City. Other blocking sizes shall be computed based upon a maximum safe allowable soil bearing pressure of twenty-five hundred (2,500) pounds per square foot of undisturbed earth.
- C. The thrust blocking shall be placed against undisturbed trench walls, with a minimum of 18-inches between trench wall and pipe. Blocking shall extend a minimum of 0.75 X pipe diameter below and above the centerline of pipe and shall not extend beyond any joints. If requested by the City, the ends of the thrust blockings shall be contained in wood or metal forms. Where upward thrusts are to be blocked, tie-down blocking shall be used in accordance with the details.

14-04 VALVE OPERATIONS NOTIFICATION: The Contractor shall provide a minimum of five (5) business days notification to the City prior to the scheduled water tie-ins that require operation of any valves. For pigging, pressure testing, and chlorinating the new water line, the Contractor shall provide a minimum of two (2) business days notification to the City prior to any

valve operation. Under no circumstances shall Contractor operate any valves without the proper approval by the City.

14-05 INTERRUPTION OF WATER SERVICE:

- A. When work performed has the potential of disrupting businesses or homestead, including but not limited to water cutoff or driveway reconstruction, Contractor shall notify the business owners, occupants and residents in writing minimum forty-eight (48) hours prior to commencing work. Contractor will be responsible to provide and place door hangers by the required time. Door hangers shall be printed in English & Spanish. See Section 11-25 Owner Notification for sample of door hangers.
- B. Scheduled water shut-offs that affect critical water customers (as identified by the City); that prevent the operation of a business or industry; or that are longer than eight (8) hours in duration shall require accommodations to minimize the disruption to service. All accommodations shall be coordinated with and approved by the Inspector and the Arlington Water Utilities Department. When temporary services or fire protections are deemed necessary by the City, payment shall be per linear foot of 2-inches temporary service, including connections to existing water mains, fire hydrants, and customer services. Payment for the temporary fire protection shall be per linear foot of 6-inches pipe, including connections to existing water mains, fire hydrants, and private fire lines.
- C. Temporary water lines must be chlorinated and receive a good sample before temporary tie-ins are performed. No additional payment shall be made for afterhours work or other accommodations.

14-06 CLEANING OF NEW WATER MAIN (C 20.6):

- A. The Contractor shall "run" the poly pigs prior to pressure testing of the new main, chlorinating the line, the obtaining of the safe water sample, and the final tie-in being made. The locations for inserting and exiting the poly pigs may be decided during the Pre-construction meeting. This work will be considered subsidiary to various bid items. The Contractor will also be required to pull a swab through the water pipe. As each joint of pipe is being laid, it shall be swabbed with a clean and effective cleaning tool as approved by the City.
- B. Contractor shall include in the pipe installation with appropriate cleaning wyes and associated appurtenances required to successfully complete the "pigging" operations. All poly pigs, cleaning wyes, and associated appurtenances shall be subsidiary to the linear foot unit price for each size and class of water line.

14-07 FIRE HYDRANTS (B 9): Refer to the latest fire hydrant specifications and detail at <http://www.arlingtontx.gov/details>. (Rev. 4/2019)

14-08 RELOCATION OF EXISTING FIRE HYDRANTS (C 12): The unit price bid for relocating existing fire hydrants shall include the cost of the necessary fittings and extensions to relocate the fire hydrants as specified on the plans and to adjust them to the finished top of curb grade.

14-09 REMOVE/SALVAGE EXISTING FIRE HYDRANT: The unit price bid shall include cost of removing and cleaning the excess concrete from the exterior of the existing fire hydrants and delivery to the City of Arlington South Services Center, 1100 SW Green Oaks Boulevard. (Rev. 4/2019)

14-10 GATE VALVES (B 10):

- A. Refer to the latest gate valve specifications and detail at <http://www.arlingtontx.gov/details>. (Rev. 4/2019)
- B. No bypass valves shall be installed for all resilient-seated gate valves, unless otherwise specified on the plans or bid PROPOSAL.
- C. Valves 12-inches or smaller shall be furnished and installed by Contractor, unless otherwise noted in the PROPOSAL. Valves 16-inches or larger will be furnished by the City. The unit price in the PROPOSAL for the installation of the 16-inches or larger valves shall include cost for pickup and loading at the South Service Center Warehouse (1100 SW Green Oaks Boulevard) and transporting to the job site. The Contractor will be responsible for inspecting the valves and ensuring good working condition of entire valve assembly prior to transporting it to the jobsite. Any damage or repairs needed to the valve assembly once it leaves the warehouse will be the responsibility of the Contractor.

14-11 WATER SERVICES:

- A. Refer to the latest water services details at <http://www.arlingtontx.gov/details>. (Rev. 4/2019)
- B. The cost of the water service shall include trench and trench safety at various depths.
- C. The contractor shall furnish, install & maintain temporary trench repair in accordance with Section 12-36 Temporary Street Repair immediately after service line installation. (Rev. 10/2019)

14-12 WATER METER REPLACEMENT:

- A. **NEW METER:**
AMI meters required for this project will be furnished by the City. The new AMI meter sizes shall match the existing meter sizes unless called out differently on the plans. The unit price in the PROPOSAL for installation of the meters shall include cost for pickup and loading at the South Service Center Warehouse (1100 SW Green Oaks Boulevard) and transporting to the job site. The Contractor will be responsible for inspecting the meters and ensuring good working condition of the entire meter assembly prior to transporting it to the jobsite. Any damage or repairs needed to the meter once it leaves the warehouse will be the responsibility of the Contractor.
- B. **METER REPLACEMENT SCHEDULING:**
Contractor shall coordinate with Inspector to ensure City Meter Services Representative will be available to pick up the old meters and take final readings. Contractor to verify size of meter prior to installation. New or replacement meters shall not be installed until after concrete flatwork is complete. (Rev. 4/2019)
- C. **METER REPLACEMENT:**
Contractor shall check for running water prior to commencing meter change-out. Contractor shall notify customer prior to water service disruption. Contractor will be responsible for turning off the water to the building. Contractor shall then replace the meter,

using new gaskets or washers. Contractor shall put plastic caps on the inlet and outlet of the old meter and handle the meter with care in the event of post-removal testing. All meter adapters, bushings, or other hardware necessary to install the new water meter in the customer's existing meter setup must be furnished by the Contractor. Contractor is required to install standard connections (meter couplings) for all 5/8-inch through 2-inches meters if none exist currently. These couplings must receive prior approval from the City. Contractor shall be responsible for bringing meter to the final grade based on the latest details with all necessary pipe and fittings. Contractor shall ensure meter wire is left in neat, working, and accessible condition. **All work on the customer side shall be completed by a licensed plumber and considered as subsidiary to the bid item for meter replacement.**

(Rev. 4/2019)

D. EXISTING METER:

Contractor shall leave the old meter inside the new meter box for City Meter Services Representative to pick up and to take final readings. Contractor shall complete new meter tag information legibly written, and attach to old meter.

(Rev. 4/2019)

E. DIRT OR WATER AROUND METER:

Contractor shall ensure the meter in the meter box has proper access, including removing and disposing any excess dirt. Dirt shall be removed such that there is a minimum of 2-inches clearance below the meter. If the water meter is fully or partially submerged, the Contractor shall remove the water prior to changing the meter. Contractor must ensure that the water service is not contaminated in any way, including intermittently by standing water in the meter box.

14-13 WATER METER RELOCATION OR ADJUSTMENT:

- A. If no meter replacement is required, the Contractor shall be responsible for relocating or adjusting (horizontal and vertical) water services, water meters to finished grade. This shall include the relocation or adjustment of the service line on the City's side of meter (from main to the meter), the quarter bend, the curb stop or angle valve, depending on service size, and the meter. The meter with curb stop or angle valve shall be adjusted accordingly with the water service detail. Relocation or adjustment of the customer's service line shall be performed by a licensed plumber. The Contractor shall also be responsible for disconnection and reconnection of antenna for AMI meters. It will be the Contractor's responsibility to notify the Inspector of any pre-existing damages prior to the relocation or adjustments.
- B. The Contractor shall also endeavor to keep meters accessible during the project construction for reading purposes. In the event the meters are covered during construction, the Contractor shall mark their locations with stakes and shall uncover the meters within twenty-four (24) hours when notified to do so by the Inspector.

14-14 WATER METER BOX REPLACEMENT:

- A. Water meter boxes will be furnished by the City. The Contractor shall provide a minimum of two (2) weeks notice to the Inspector prior to picking the meter boxes from the South Service Center Warehouse, 1100 SW Green Oaks Boulevard, and transporting to the job site. Water meter boxes damaged by the Contractor shall be replaced at the Contractor's expense.

- B. The Contractor shall also be responsible for disconnection and reconnection of antenna used for AMI meters. All meter boxes shall be set to the finished grade. All work related to meter boxes and antenna shall be considered subsidiary to the various bid items unless otherwise indicated in the bid PROPOSAL as a pay item. It will be the Contractor's responsibility to notify the Inspector of any pre-existing damages prior to the replacement.

14-15 ABANDONING EXISTING VALVE BOX AND MANHOLE:

(Rev 10/2018)

- A. The unit price for abandoning existing valve boxes shall include removing the top 10-inches or top section, fill void area with sand or approved material, backfill and compact per backfill specifications, and repair pavement if located in street, or replace with 2-inches of topsoil including hydromulch or sod if located at back of curb.
- B. The unit price for abandoning existing manholes shall include removing the cone or top section, plugging all penetrations with concrete, fill void with sand or an approved material, backfill and compact per backfill specifications from top of manhole section to subgrade if within pavement limits or to 2-inches below grade if outside pavement limits. Repair pavement per permanent or temporary pavement repair specifications or install 2-inches of topsoil including hydromulch or sod to match existing grade if located at back of curb.

14-16 POLY-VINYL CHLORIDE (PVC) SEWER PIPE & FITTINGS (B 7):

A. SCOPE:

This specification designates general requirements for unplasticized, poly-vinyl chloride (PVC), plastic gravity sewer pipe with integral wall bell and spigot joints for the conveyance of domestic sewage. The pipe and fittings shall be in accordance with the latest ASTM D3034 or F679 SDR 26 pipe, or as specified in the bid PROPOSAL.

B. MATERIALS:

Pipe shall be made from clean, virgin, approved Class 12454 BC PVC compound conforming to ASTM resin specification D 1784. Clean reworked material generated from the manufacturer's own production may be used.

C. PIPE:

All pipe shall be suitable for use as a gravity sewer conduit. Provisions must be made for contraction and expansion at each joint with a rubber ring. The rings shall securely lock the solid cross section rubber ring into position. Standard lengths shall be 20-feet and 13-feet, +/- 1-inch.

D. FITTINGS:

All fittings and accessories shall be as manufactured and furnished by the pipe supplier or approved equal and have bell and spigot configurations identical to that of the pipe. Adapters appropriate for the existing pipe material shall be used to tie into existing pipe for the service lines and laterals. No separate payment will be made for adapters, tees, bends or other necessary fittings used in the installation of this line but shall be considered to be subsidiary to the unit prices for pipe and services.

E. PHYSICAL AND CHEMICAL REQUIREMENTS:

Pipe shall be designated to pass all tests at seventy-three (73) degrees F (+/- three (3) degrees F).

F. PIPE STIFFNESS:
Minimum "pipe stiffness" (F/Y at 5% deflection) shall be calculated in accordance with ASTM Designation D 2412, External Loading Properties of Plastic Pipe by Parallel-Plate Loading.

G. JOINT TIGHTNESS:
Assemble two sections of pipe in accordance with the manufacturer's recommendations. Subject the joint to an internal hydrostatic pressure of twenty-five (25) psi for one hour. Consider any leakage failure of the test requirements.

H. FLATTENING:
There shall be no evidence of splitting, cracking, or breaking when the pipe is tested as follows:

Flatten specimen of pipe, 6-inches long between parallel plates in a suitable press until the distance between the plates is forty percent (40%) of the outside diameter of the pipe. The rate of loading shall be uniform and such that the compression is completed within two (2) to five (5) minutes.

I. DROP IMPACT TEST:
Pipe (6-inches long section) shall be subjected to impact from a free falling tup (20 lb. Tup A) in accordance with ASTM method D 2444. No shattering or splitting (denting is not a failure) shall be evident when the following energy is impacted:

<u>Nominal Size</u>	4"	6"	8"	10"	12"
<u>Ft. - Lbs.</u>	150	210	210	220	220

J. ACETONE IMMERSION TEST:
After two (2) hours immersion in a sealed container of anhydrous (99.5% pure) acetone, a 1-inch long sample ring shall show no visible spalling or cracking. (Swelling or softening is not a failure when tested in accordance with ASTM D 2152.)

K. PAYMENT:
The price bid per linear foot for PVC pipe at the various depths shall be full compensation for all material, labor, equipment, and incidental work required to complete the line ready for use, including embedment and seepage collars. The cost of trenching, embedment, seepage collars, backfill, compaction of backfill and exfiltration testing should be included in the unit price bid per linear foot, complete in place.

14-17 EMBEDMENT REQUIREMENTS FOR SANITARY SEWER PIPE & FITTINGS (B 19 & C 3.14): Unless otherwise specified, all sanitary sewer pipes shall be in accordance with Class "B" embedment detail.

14-18 LOW PRESSURE AIR TEST OF SANITARY SEWER LINES (C 29):

A. After completing backfill of a section of sanitary sewer line, the Contractor shall, at his expense, conduct a Line Acceptance Test using low-pressure air. The test shall be performed using the below stated equipment according to stated procedures and under the supervision of the City.

1. EQUIPMENT: The equipment used shall meet the following minimum requirements:

- a. Pneumatic plugs shall have a sealing length equal to or greater than the diameter of the pipe to be inspected.
 - b. Pneumatic plugs shall resist internal test pressures without requiring external bracing or blocking.
 - c. All air used shall pass through a single control panel.
 - d. Three individual hoses shall be used for the following connections:
 - i. From the control panel to pneumatic plugs for inflation.
 - ii. From the control panel to a sealed line for introducing the low-pressure air.
 - iii. From a sealed line to control panel for continually monitoring the air pressure rise in the sealed line.
2. GENERAL PROCEDURE:
- a. All pipe shall be backfilled prior to air testing.
 - b. Air tests shall be made by the pressure drop versus time method. The air test shall be performed by testing sections of pipe of various lengths. The Contractor shall furnish all material, equipment and labor necessary to perform the air test. Air gauges shall be recently calibrated and shall be stamped showing the date of calibration. Should the sanitary sewer system fail air tests, the Contractor shall repair the leaks and retest at his own expense.
3. TESTING PIPE LESS THAN 36 INCHES IN DIAMETER:
- a. Pneumatic plugs shall have a sealing length equal to or greater than the diameter of the pipe to be inspected. Pneumatic plugs shall resist internal test pressures without requiring external bracing or blocking. All air used shall pass through a single control panel.
 - b. Three individual hoses shall be used for the following connections: from the control panel to pneumatic plugs for inflation; from the control panel to a sealed line for introducing the low-pressure air; and from a sealed line to the control panel for continually monitoring the air pressure rise in the sealed line.
 - c. The air compressor shall be of adequate capacity for charging the system.
 - d. The following procedure shall be used for air testing a sewer system: all pneumatic plugs shall be seal-tested before being used in the actual test installation; one length of pipe shall be laid on the ground and sealed at both ends with the pneumatic plugs to be checked; air shall be introduced into the plugs to twenty-five (25) psig; the sealed pipe shall be pressurized to five (5) psig; the plugs shall hold against this pressure without bracing and without movement of the plugs out of this pipe.

- e. After a manhole-to-manhole reach of pipe has been backfilled and the pneumatic plugs checked, the plugs shall be placed in the line and inflated to twenty-five (25) psig. Low pressure air shall be injected into the line until the internal pressure reaches four (4) psig. Two (2) minutes shall then be allowed for the pressure to stabilize.
 - f. In areas where ground water is known to exist, the Contractor shall install a ½-inch diameter capped pipe nipple, approximately 10-inches long, through the manhole. This shall be done at the time the sewer line is installed. Immediately prior to the performance of the Line Acceptance Test, the ground water shall be determined by removing the pipe cap, blowing air through the pipe nipple into the ground so as to clean it, and then connecting a clear plastic tube to the pipe nipple. The hose shall be held vertically and a measurement of the height (in feet) of water over the invert of the pipe shall be taken after the water has stopped rising in this plastic tube. The height shall be divided by 2.3-feet to establish the pounds of pressure that will be added to all readings.
 - g. After the pipe pressure has stabilized at three and a half (3.5) psig or the adjusted pressure due to ground water submergence, a stop watch shall be started and the time required for the internal pressure to reach two and a half (2.5) psig determined. Minimum permissible holding time for runs of single pipe diameter are indicated in the table under Section C 29.
4. EXAMPLE: If the height of water is 11½-feet, then the added pressure will be psig. This will increase the three and a half (3.5) psig to eight and a half (8.5) psig and the two and a half (2.5) psig to seven and a half (7.5) psig. The allowable drop and the timing remain the same. Refer to the City's Standard Specification for Water and Sanitary Sewer Construction, Section C 29 for air test tables.
5. TESTING PIPE 36 INCHES AND LARGER IN DIAMETER: For pipes 36-inches in diameter and over, the air test may be performed by testing each joint connection individually utilizing a joint tester similar to the Cherne Joint Tester. No joint shall be air tested until the pipe has been backfilled. At no time shall pipe installation exceed 100-feet from the latest joint tested. The method of testing shall be described in this section. The time allowed for the pressure drop for three and a half (3.5) psig to two and a half (2.5) psig shall be ten (10) seconds. Failure to pass the air test shall be cause for rejection. Rejected pipe shall be removed. Reinstallation and/or repairs may be made at the option of the City.
6. MEASUREMENT AND PAYMENT: No separate payment will be made for the tests specified herein, but the cost thereof shall be subsidiary to the various bid items.
- B. IF THE INSTALLATION FAILS TO MEET THIS REQUIREMENT, THE CONTRACTOR SHALL DETERMINE, AT HIS OWN EXPENSE, THE SOURCE OF LEAKAGE. CONTRATOR SHALL REPLACE ALL DEFECTIVE MATERIALS AND/OR WORKMANSHIP UNTIL RETEST(S) IS IN COMPLIANT.

14-19 DEFLECTION TESTING OF FLEXIBLE SANITARY SEWER (C 27):

- A. PVC and any other flexible sewer pipe shall pass a deflection test conducted under the inspection of the City. A rigid mandrel shall be used to measure deflection. The rigid

mandrel shall have an outside diameter (OD) equal to ninety-five percent (95%) of the inside diameter (ID) of the pipe. The inside diameter of the pipe, for the purpose of determining the outside diameter of the mandrel, shall be the average outside diameter minus two (2) minimum wall thicknesses for an OD controlled pipe and the average inside diameter for an ID controlled pipe. Statistical or other tolerance packages shall not be considered in mandrel sizing.

- B. Deflection tests shall be conducted after the final backfill has been in place at least thirty (30) days. No pipe shall exceed a deflection of five percent (5%). If a pipe fails to pass the deflection test, the Contractor, at his own expense, shall replace one complete length of pipe at the point of failure.
- C. No separate payment will be made for the tests specified herein, but the cost thereof shall be included and considered subsidiary to the various other items.

14-20 SANITARY SEWER SERVICE:

- A. The cost of the 4-inch or larger sanitary sewer service shall include connecting into the main and existing service, embedment, trench and trench safety, and other materials and labor for the installation at various depths.
- B. The contractor shall furnish, install & maintain temporary trench repair in accordance with Section 12-36 Temporary Street Repair immediately after service line installation.

(Rev. 10/2019)

14-21 BYPASS PUMPING: Bypass pumping required for performance of the project will be considered subsidiary to the unit prices bid on this project unless otherwise indicated in the bid PROPOSAL as a pay item.

14-22 CAST-IN-PLACE MANHOLES (C 18.3):

- A. Cast-in-place concrete manholes shall have a minimum inside diameter at the base of 4-feet or 5-feet. The Contractor shall not remove any forms until twenty-four (24) hours after the concrete is placed. No backfill shall begin until ninety-six (96) hours after the concrete is placed.
- B. Rim elevation of manholes shall be adjusted to match existing grade.
- C. A fiberglass manhole marker shall be installed 3-feet from the edge of the concrete pad. The marker shall be embedded at least 6-inches into the ground and shall extend at least 72-inches above the top of the concrete pad. The marker shall be white with a white on green, ultra-violet light resistant label indicating SANITARY SEWER MANHOLE.

14-23 CCTV INSPECTION OF SANITARY SEWER MAINS (C 28):

- A. SCOPE
This section of the specifications covers the City inspection of sanitary sewer mains by closed circuit television (CCTV).
- B. GENERAL
The final inspection on all projects shall include a CCTV inspection of the completed sanitary sewer main installation, exclusive of services. The CCTV inspection, including furnishing of necessary personnel, equipment and materials, shall be performed by the Contractor. All defects in the installed facility revealed by the CCTV inspection shall

be remedied by the Contractor prior to the acceptance of the project.

C. CONTRACTOR'S RESPONSIBILITIES

1. Prior to pavement placement (if sanitary sewer is under pavement) or prior to sanitary sewer main acceptance (if sanitary sewer is in parkway), the Contractor shall inspect all newly constructed mains, excluding services, by CCTV in accordance to the National Association of Sewer Service Companies (NASSCO) Pipeline Assessment & Certification Program (PACP) standards, latest edition. The Contractor shall provide the City a CCTV inspection video and a PACP inspection report summarizing the inspection with all PACP observation codes with their corresponding Structural Grade and O&M condition grades clearly marked. The inspection shall be performed by a NASSCO PACP Certified Inspector, and the report shall clearly show the CCTV Inspector's name and registration number. In addition to defects noted for NASSCO PACP sanitary sewer standards, the CCTV Inspector shall note any defects that meet the NASSCO PACP definition of 'Joint Offset Small (JOS)', Joint Separated Small (JSS)', or 'Joint Angular Small (JAS)'. Such defects shall be clearly highlighted, emboldened, circled or marked in a way to distinguish them from the other observation codes.
2. The sanitary sewer main shall be thoroughly cleaned and flushed with water, by the Contractor, prior to CCTV inspection. The pipe shall have flow depth less than a quarter (1/4) pipe full unless approved by the City in writing.
3. The Contractor will be held liable for all damages to the public and private property caused directly and/or indirectly by the CCTV inspection or by surcharging of sanitary sewer mains. The Contractor is responsible for any fines, penalties or other costs imposed upon the City by any agency or private party as a result of the CCTV inspection or improper discharges by the Contractor. The Contractor shall ensure no equipment or other obstructions remain in the line after inspection. All costs associated with retrieving any lodged equipment, shall be incidental to the inspection.

D. BASIS FOR CCTV REPORT ACCEPTANCE

CCTV inspection report must indicate under C 28.3 has a PACP Overall Pipe Structural and O&M Rating of 0, and contains no defects meeting the NASSCO PACP definition of JOS, JSS, or JAS. Any defects observed shall be corrected and re-inspected by the Contractor prior to completion at the Contractor's expense.

E. MEASUREMENT AND PAYMENT

Payment will be at the unit price bid per linear foot of CCTV inspection of sanitary sewer mains.

14-24 DISPOSAL OF EXCESS MATERIAL (C 3.12): The disposal of excess material resulting from construction **including asbestos-cement pipe** shall be removed and disposed of by the Contractor. Removal and disposal of **asbestos-cement pipe** shall be in accordance with the latest Federal and State regulations. The location of suitable disposal sites is solely the responsibility of the Contractor; the City shall in no way be responsible for the actions of the Contractor. Unless otherwise indicated in the bid PROPOSAL, this work will be considered subsidiary to various bid items.

14-25 PIPE HANDLING:

- A. Pipe, fittings, valves and other accessories shall at all times be handled with care to avoid damage. In loading and unloading they shall be lifted by hoists, cranes or rolled on skidways in a manner which avoids sudden shock. Under no circumstance shall pipe be dropped. Pipe handled on skidways must not be skidded or rolled against pipe already on the ground. Pipe shall be placed on the site of the work parallel with the trench alignment and with the bell ends facing the direction in which the work will proceed.

- B. Proper implements, tools, equipment and facilities shall be provided and used by the Contractor for the correct and safe execution of the work. All pipe, fittings, specials, valves, etc. shall be lowered into the trench by means of a suitable machine and shall not be rolled or dumped into the trench. The equipment shall have sufficient capacity to handle the pipe. The method of construction shall be subject to the City's approval. Before being lowered into the trench, each joint of pipe shall be inspected and any unsound or damaged pipe shall be repaired or rejected.

- C. Pipe shall be kept free of all debris during the laying operation. The pipe shall be swept or swabbed prior to installation. At the close of each operating day, the open end of the pipe shall be effectively sealed with an approved water tight plug. The swab and plug shall be of a design acceptable to the City. No pipe shall be laid in water or when the trench conditions or the weather are unsuitable for such work, except in an emergency and then only upon permission of the City.

- D. All pipe shall be laid accurately to established lines and grades with valves and fittings at the required locations and with joints centered and spigots pushed home. Where it becomes necessary to make deflections in the line of the pipe, sections of pipe beveled ends or fabricated fittings shall be used. Minor deflection of the line of the pipe may be obtained in standard pipe joints; however, the maximum joint opening caused by such deflection shall not exceed the recommendations of the pipe manufacturer. Random length pipe and/or grade adapters may be used to make unforeseen changes in the field.

14-26 TYING INTO EXISTING LINES (C 25): The unit price bid for tying into existing lines shall include all labor and material necessary to tie the old main into the new main. The Contractor shall furnish all labor, material, equipment, and services required for the locating and uncovering of the existing line, the making of cuts in the line, the removal, relocation, and lowering or raising of existing lines as required, de-watering of the trench, connecting of the existing line into the new main and all appurtenant work required for a complete connection. This shall include the cost of offset bends as necessary for vertical and/or horizontal alignment. The new water lines will have to be tested, chlorinated, and a good sample received before the old lines can be plugged or abandoned and the new line tied in.

14-27 PLUGGING EXISTING LINES TO BE ABANDONED: All dead ends and abandoned lines shall be capped or plugged accordingly. Bell ends shall be plugged whereas spigot ends and plain ends shall be capped. Unit price for plugging existing lines shall include the cost of all labor and material necessary to perform this work.

14-28 DUCTILE IRON PIPE (B 5):

- A. Where ductile iron pipe is chosen for use on this project, it shall be furnished and installed in accordance with the applicable provisions of the Standard Specifications, the details shown on the plans and as hereinafter specified.
- B. All ductile iron pipe shall conform to the requirements of the latest revision of ANSI/AWWA C151/A21.51 and ANSI/AWWA C150/A21.50 for the minimum thickness.
- C. All ductile iron pipe shall be asphaltic coated outside in accordance with the latest revision of ANSI/AWWA C151/A21.51.
- D. Ductile iron pipe for water line shall have a cement-mortar lining in accordance with latest revision of ANSI/AWWA C104/A21.4.
- E. Ductile iron pipe for sanitary sewer line shall be lined with Protecto 401 Ceramic Epoxy lining.
- F. All ductile iron pipe joints shall be "Push On" Type and shall conform to the latest revision of ANSI/AWWA C111/A21.11.
- G. All ductile iron pipe shall be wrapped by polyethylene encasement in accordance with latest revision of ANSI/AWWA C105/A21.5.
- H. Restrained joint shall be mechanically interlocking joint and used at the locations indicated on the plans. Restrained joints shall be U.S. Pipe "TR Flex", American Ductile Iron Pipe "Flex Ring", Clow Corporation "Super-Lock", or approved equal. Field welding will not be allowed.
- I. The price bid per linear foot for ductile iron pipe at the various depths shall be full compensation for all material, labor, equipment, and incidental work required to complete the line ready for use, including trenching, embedment, backfill, and testing.

14-29 DUCTILE IRON FITTINGS (B 15):

- A. All fittings shall comply with the latest revision of ANSI/AWWA C110/A21.10 or ANSI/AWWA C153/A21.53, and designed for a working pressure of not less than one hundred fifty (150) psi.
- B. Ductile iron fittings for water lines shall have a "Standard Thickness" cement mortar lining and bituminous seal coat over the cement mortar lining in accordance with the latest revision of ANSI/AWWA C104/A21.4 and ANSI/AWWA C110/A21.10,
- C. Ductile iron fittings for sanitary sewer shall be lined with Protecto 401 Ceramic Epoxy coating of 40 mils nominal thickness.
- D. All fittings shall be installed with a double layer of polyethylene wrap in compliance with A.W.W.A Standard C105 (ANSI A21.5).
- E. Only those manufacturers whose ductile iron fittings have been specifically approved by Arlington Water Utilities Department can be used in the City's water and sanitary sewer system.

- F. Ductile iron fittings, including polywrap, blocking, bolts, gaskets, or any other joint accessories, shall be subsidiary to the price bid for pipe.

14-30 GPS DATA ON WATER & SANITARY SEWER INSTALLATION: (Rev 6/2020)

City crew will collect the GPS data on the water and sanitary sewer attributes installed with this project, including construction of new or adjustment and relocation of existing water and sanitary attributes. Examples of water and sewer attributes includes: Gate Valves, Blow-off Valves, Air Release Valves, Fire Hydrants, Meter Boxes, Pig Wye Vaults, Manhole Lids and Flowlines, and Cleanout Lids.

Contractor shall notify the Project Inspector prior to the final walk through that all the attributes are ready for GPS data collections.

The final payment will not be processed until any missing attributes are exposed and brought to the final grades.

14-31 WORK ON THE EXISTING 33-INCH AND 27-INCH WATER MAINS: The existing 33-inch and 27-inch water mains from Bowen Road to Fielder Road cannot be out of service at the same time. The work on these two mains that will require the line out of the service **cannot be performed between June 1, 2022 and October 1, 2022.** The schedule shall be submitted to the Project Engineer at least 30 days prior to performing the actual work and approved by the Arlington Water Utilities Department.

All the existing connections called out on the plans to be disconnected from the existing 33-inch water main and all the work called out on the 27-inch water main shall be completed within 15 calendar days, respectively, including the chlorination. The contractor shall work on a 24-hour schedule until the 33-inch and 27-inch water mains are back in service. Working on a 24-hour schedule shall be considered subsidiary to the various bid items.

END OF SECTION

SECTION NO. 15

SPECIAL PROVISIONS – DRAINAGE SPECIFICATIONS

NUMERICAL LISTING

New Section
No.

15-01	REINFORCED CONCRETE PIPE
15-02	HIGH DENSITY POLYETHYLENE PIPE (HDPE)
15-03	UNCLASSIFIED DRAINAGE STRUCTURAL EXCAVATION
15-04	CONCRETE DRAINAGE STRUCTURES
15-05	UNCLASSIFIED CHANNEL EXCAVATION
15-06	REINFORCED CONCRETE CHANNEL/SLOPE
15-07	CCTV INSPECTIONS OF STORM DRAIN SYSTEMS
15-08	GPS DATA ON STORMWATER ATTRIBUTES
15-09	TEMPORARY SHORING

SECTION NO. 15

SPECIAL PROVISIONS – DRAINAGE SPECIFICATIONS

15-01 REINFORCED CONCRETE PIPE:

- A. Pipe for storm drains and culverts shall conform to the latest TxDOT Standard Specifications Item 462. All pipes shall be machine made by a process which will provide for uniform placement of zero slump concrete in the form of compaction by mechanical devices which will assure a dense concrete in the finished product. All excavation, bedding, jointing, and backfilling shall be done in accordance with the latest NCTCOG Specifications unless as modified in these Special Provisions.
- B. At the request of the City, the Contractor will be required to furnish and use a laying schedule supplied by the manufacturer showing location of all bends, fittings, and beveled end joints required to accurately construct the system, including curves, as shown on the plans. The pipe will not be laid until the requested laying schedule has been reviewed and accepted by the City for construction purposes.
- C. The laying schedule shall be based on all pipe joints constructed to the "home" or normal position and the distance between the ends of adjacent pipe sections will be essentially uniform around the periphery of the pipe. OMNI-FLEX® (or approved equal) joint sealer shall be used on all joints and the joint gap range shall not exceed the manufacturer's recommendations.
- D. After the trench has been cut to depth below the barrel of the pipe, the bedding shall be brought up to a point slightly above the grade. Bell holes shall be formed, a trough scooped out to grade and the pipe laid and jointed as specified.
- E. The pipe shall be bedded in a minimum of 6-inches crushed stone except in rock or in wet or unstable trenches where an additional 3-inches of crushed stone will be added to the standard bedding requirements. Crushed stone shall meet the latest NCTCOG Specifications 504.2.2.1 Crushed Stone Embedment - Aggregate Grade 4. River rock/gravel will be allowed as long as it meets this gradation requirement.
- F. After the pipe has been laid and the joints made, crushed stone shall be placed from the bottom of the pipe to the **top** of pipe. The material shall be placed uniformly on both sides of the pipe in order to prevent disturbance of the pipe and, if necessary, blocking shall be placed against the sides of the trench to prevent displacement of the pipe. The material shall be worked under the haunches of the pipe during the time it is being placed. Filter fabric shall be placed over the full width of the embedment prior to trench backfill operations.
- G. For the remaining backfill operations, see respective trench backfill specifications in these Special Provisions.
- H. Payment for all reinforced concrete pipe shall be based on the contract unit price bid per linear foot of pipe measured along the centerline of the pipe in the trench and shall be full

compensation for all labor and materials necessary to make the complete installation, including but not limited to excavation, bedding, jointing, backfilling and joint sealer. The cost of constructing concrete collars, tees, and wyes shall be considered subsidiary to the unit prices bid for reinforced concrete pipe, unless an item has been provided in the PROPOSAL.

- I. If cast in place reinforced box culvert is used, it shall be constructed in accordance with TxDOT Item 462. If multiple precast box sections are used and the void space between culvert walls is less than 6-inches, it shall be backfilled using flowable fill of at least six hundred (600) psi concrete. If the void is 6-inches or more, standard embedment material shall be used.
- J. Payment for the box culvert shall be measured by the linear foot of box culvert, including the reinforcing steel using the length between the ends of the culvert barrel along the central axis as constructed. Payment shall be complete in place, including excavation and backfill, furnishing all materials, labor and incidentals, and performing all work necessary to complete the work.

15-02 HIGH DENSITY POLYETHYLENE PIPE (HDPE): N/A

15-03 UNCLASSIFIED DRAINAGE STRUCTURAL EXCAVATION: N/A

15-04 CONCRETE DRAINAGE STRUCTURES: N/A

15-05 UNCLASSIFIED CHANNEL EXCAVATION: N/A

15-06 REINFORCED CONCRETE CHANNEL/SLOPE: N/A

15-07 CCTV INSPECTIONS OF STORM DRAIN SYSTEMS: N/A

15-08 GPS DATA ON STORMWATER ATTRIBUTES: N/A

15-09 TEMPORARY SHORING: N/A

END OF SECTION

SECTION 16

TRENCH SAFETY AND OSHA

- A. Pursuant to law, trench safety systems are required for all trench excavations that exceed a depth of five feet and shall require a safety program which governs the presence and activities of individuals working in and around the trench excavation. The trench safety systems and safety program shall be in accordance with current Occupational Safety and Health Administration (OSHA) standards. A copy of the OSHA standards is included for the Contractor's convenience. However, the Contractor must check current and future OSHA Rules as they may change from time to time.
- B. The low bidder shall be required to submit a trench safety plan to the project engineer at least 10 days prior to beginning work on the project that will involve trenching operations. The trench safety plan shall be in accordance with current OSHA rules and regulations. The trench safety plan shall specify the method or methods of trench safety to be used with specific information given for each. If the Contractor chooses to use an option from OSHA in the design of sloping and benching systems or design of support systems, shield systems, and other protective systems which requires that the soil be classified as Type A, B, or C, the Contractor shall be required to provide soil investigations and testing necessary to classify the soil type. Soil investigation information must include location and depth. The review of the trench safety plan by the City of Arlington is only for general conformance with OSHA rules and regulations and to ensure sufficient information for inspection purposes. The review in no way relieves the Contractor from responsibility for trench safety in accordance with current law.
- C. Each bidder shall satisfy himself, by personal examination of the location of the proposed work and by such other means as he may prefer, as to the requirements of the work to enable him to construct his proposal intelligently. The bidder shall make himself familiar with all of the Contract Documents and other instructions before submitting his proposal (bid) in order that no misunderstanding shall exist in regard to the nature and character of the work to be done. No allowance will be made for any claim that the proposal is based upon incomplete information as to the nature and character of the site or the work involved. Conditional proposals will not be accepted.
- D. The Contractor shall make daily inspections of the Trench Safety Systems to ensure that the systems meet OSHA requirements. Daily inspection is to be made by a "competent person" provided by the Contractor. If evidence of possible cave-ins or slides is apparent, all work in the trench shall cease until the necessary precautions have been taken by the Contractor to safeguard personnel entering the trench. It is the sole duty, responsibility and prerogative of the

Contractor, not the owner or the Engineer, to determine the specific applicability of the designed trench safety systems to each field condition encountered on the project.

- E. **The Contractor shall indemnify and hold harmless the City, its employees and agents, from any and all damages, costs, (including, but not limited to, attorney's fees, court costs, and costs of investigation) judgments or claims by anyone for damage to property, injury or death or persons resulting from the collapse or failure of any trenches, ditches or other excavations constructed under or associated with this contract.**

It is the express intention of the parties, both Contractor and the City, and the Contractor acknowledges and agrees that this indemnity provision provides indemnity by the Contractor to indemnify and protect the City from the consequences of the City's own negligence, whether that negligence is the sole of concurring cause of the injury, death or damage and in the case the City is negligent either by act or omission in providing for trench safety, including but not limited to inspections, failure to issue stop work orders, and the hiring of the Contractor.

- F. Included in the proposal is a separate pay item for the trench safety system and the trench safety program. This pay item will be a linear foot basis and will be full compensation for labor, tools, materials, equipment, and incidentals to complete the work. All requirements as outlined in this section will be incorporated within this bid item. Should conditions during construction require that alternate methods of trench safety be used, the Contractor shall submit a revised trench safety plan following the same guidelines as in B. There will be no additional compensation for changes in the trench safety plan as may be required during construction due to changes in conditions. 9/27/04

§ 1926.650

29 CFR Ch. XVII (7–1–12 Edition)

(c) *Coaming*—The raised frame, as around a hatchway in the deck, to keep out water.

(d) *Jacob's ladder*—A marine ladder of rope or chain with wooden or metal rungs.

(e) *Rail*, for the purpose of § 1926.605, means a light structure serving as a guard at the outer edge of a ship's deck.

Subpart P—Excavations

AUTHORITY: Sec. 107, Contract Worker Hours and Safety Standards Act (Construction Safety Act) (40 U.S.C. 333); Secs. 4, 6, 8, Occupational Safety and Health Act of 1970 (29 U.S.C. 653, 655, 657); Secretary of Labor's Order No. 12–71 (36 FR 8754), 8–76 (41 FR 25059), or 9–83 (48 FR 35736), as applicable, and 29 CFR part 1911.

SOURCE: 54 FR 45959, Oct. 31, 1989, unless otherwise noted.

§ 1926.650 Scope, application, and definitions applicable to this subpart.

(a) *Scope and application.* This subpart applies to all open excavations made in the earth's surface. Excavations are defined to include trenches.

(b) *Definitions applicable to this subpart.*

Accepted engineering practices means those requirements which are compatible with standards of practice required by a registered professional engineer.

Aluminum Hydraulic Shoring means a pre-engineered shoring system comprised of aluminum hydraulic cylinders (crossbraces) used in conjunction with vertical rails (uprights) or horizontal rails (walers). Such system is designed, specifically to support the sidewalls of an excavation and prevent cave-ins.

Bell-bottom pier hole means a type of shaft or footing excavation, the bottom of which is made larger than the cross section above to form a belled shape.

Benching (Benching system) means a method of protecting employees from cave-ins by excavating the sides of an excavation to form one or a series of horizontal levels or steps, usually with vertical or near-vertical surfaces between levels.

Cave-in means the separation of a mass of soil or rock material from the side of an excavation, or the loss of soil from under a trench shield or support

system, and its sudden movement into the excavation, either by falling or sliding, in sufficient quantity so that it could entrap, bury, or otherwise injure and immobilize a person.

Competent person means one who is capable of identifying existing and predictable hazards in the surroundings, or working conditions which are unsanitary, hazardous, or dangerous to employees, and who has authorization to take prompt corrective measures to eliminate them.

Cross braces mean the horizontal members of a shoring system installed perpendicular to the sides of the excavation, the ends of which bear against either uprights or wales.

Excavation means any man-made cut, cavity, trench, or depression in an earth surface, formed by earth removal.

Faces or *sides* means the vertical or inclined earth surfaces formed as a result of excavation work.

Failure means the breakage, displacement, or permanent deformation of a structural member or connection so as to reduce its structural integrity and its supportive capabilities.

Hazardous atmosphere means an atmosphere which by reason of being explosive, flammable, poisonous, corrosive, oxidizing, irritating, oxygen deficient, toxic, or otherwise harmful, may cause death, illness, or injury.

Kickout means the accidental release or failure of a cross brace.

Protective system means a method of protecting employees from cave-ins, from material that could fall or roll from an excavation face or into an excavation, or from the collapse of adjacent structures. Protective systems include support systems, sloping and benching systems, shield systems, and other systems that provide the necessary protection.

Ramp means an inclined walking or working surface that is used to gain access to one point from another, and is constructed from earth or from structural materials such as steel or wood.

Registered Professional Engineer means a person who is registered as a professional engineer in the state where the work is to be performed. However, a professional engineer, registered in any

state is deemed to be a "registered professional engineer" within the meaning of this standard when approving designs for "manufactured protective systems" or "tabulated data" to be used in interstate commerce.

Sheeting means the members of a shoring system that retain the earth in position and in turn are supported by other members of the shoring system.

Shield (Shield system) means a structure that is able to withstand the forces imposed on it by a cave-in and thereby protect employees within the structure. Shields can be permanent structures or can be designed to be portable and moved along as work progresses. Additionally, shields can be either premanufactured or job-built in accordance with §1926.652 (c)(3) or (c)(4). Shields used in trenches are usually referred to as "trench boxes" or "trench shields."

Shoring (Shoring system) means a structure such as a metal hydraulic, mechanical or timber shoring system that supports the sides of an excavation and which is designed to prevent cave-ins.

Sides. See "Faces."

Sloping (Sloping system) means a method of protecting employees from cave-ins by excavating to form sides of an excavation that are inclined away from the excavation so as to prevent cave-ins. The angle of incline required to prevent a cave-in varies with differences in such factors as the soil type, environmental conditions of exposure, and application of surcharge loads.

Stable rock means natural solid mineral material that can be excavated with vertical sides and will remain intact while exposed. Unstable rock is considered to be stable when the rock material on the side or sides of the excavation is secured against caving-in or movement by rock bolts or by another protective system that has been designed by a registered professional engineer.

Structural ramp means a ramp built of steel or wood, usually used for vehicle access. Ramps made of soil or rock are not considered structural ramps.

Support system means a structure such as underpinning, bracing, or shoring, which provides support to an adja-

cent structure, underground installation, or the sides of an excavation.

Tabulated data means tables and charts approved by a registered professional engineer and used to design and construct a protective system.

Trench (Trench excavation) means a narrow excavation (in relation to its length) made below the surface of the ground. In general, the depth is greater than the width, but the width of a trench (measured at the bottom) is not greater than 15 feet (4.6 m). If forms or other structures are installed or constructed in an excavation so as to reduce the dimension measured from the forms or structure to the side of the excavation to 15 feet (4.6 m) or less (measured at the bottom of the excavation), the excavation is also considered to be a trench.

Trench box. See "Shield."

Trench shield. See "Shield."

Uprights means the vertical members of a trench shoring system placed in contact with the earth and usually positioned so that individual members do not contact each other. Uprights placed so that individual members are closely spaced, in contact with or interconnected to each other, are often called "sheeting."

Wales means horizontal members of a shoring system placed parallel to the excavation face whose sides bear against the vertical members of the shoring system or earth.

§ 1926.651 Specific excavation requirements.

(a) *Surface encumbrances.* All surface encumbrances that are located so as to create a hazard to employees shall be removed or supported, as necessary, to safeguard employees.

(b) *Underground installations.* (1) The estimated location of utility installations, such as sewer, telephone, fuel, electric, water lines, or any other underground installations that reasonably may be expected to be encountered during excavation work, shall be determined prior to opening an excavation.

(2) Utility companies or owners shall be contacted within established or customary local response times, advised of

the proposed work, and asked to establish the location of the utility underground installations prior to the start of actual excavation. When utility companies or owners cannot respond to a request to locate underground utility installations within 24 hours (unless a longer period is required by state or local law), or cannot establish the exact location of these installations, the employer may proceed, provided the employer does so with caution, and provided detection equipment or other acceptable means to locate utility installations are used.

(3) When excavation operations approach the estimated location of underground installations, the exact location of the installations shall be determined by safe and acceptable means.

(4) While the excavation is open, underground installations shall be protected, supported or removed as necessary to safeguard employees.

(c) *Access and egress*—(1) *Structural ramps*. (i) Structural ramps that are used solely by employees as a means of access or egress from excavations shall be designed by a competent person. Structural ramps used for access or egress of equipment shall be designed by a competent person qualified in structural design, and shall be constructed in accordance with the design.

(ii) Ramps and runways constructed of two or more structural members shall have the structural members connected together to prevent displacement.

(iii) Structural members used for ramps and runways shall be of uniform thickness.

(iv) Cleats or other appropriate means used to connect runway structural members shall be attached to the bottom of the runway or shall be attached in a manner to prevent tripping.

(v) Structural ramps used in lieu of steps shall be provided with cleats or other surface treatments on the top surface to prevent slipping.

(2) *Means of egress from trench excavations*. A stairway, ladder, ramp or other safe means of egress shall be located in trench excavations that are 4 feet (1.22 m) or more in depth so as to require no more than 25 feet (7.62 m) of lateral travel for employees.

(d) *Exposure to vehicular traffic*. Employees exposed to public vehicular traffic shall be provided with, and shall wear, warning vests or other suitable garments marked with or made of reflectorized or high-visibility material.

(e) *Exposure to falling loads*. No employee shall be permitted underneath loads handled by lifting or digging equipment. Employees shall be required to stand away from any vehicle being loaded or unloaded to avoid being struck by any spillage or falling materials. Operators may remain in the cabs of vehicles being loaded or unloaded when the vehicles are equipped, in accordance with §1926.601(b)(6), to provide adequate protection for the operator during loading and unloading operations.

(f) *Warning system for mobile equipment*. When mobile equipment is operated adjacent to an excavation, or when such equipment is required to approach the edge of an excavation, and the operator does not have a clear and direct view of the edge of the excavation, a warning system shall be utilized such as barricades, hand or mechanical signals, or stop logs. If possible, the grade should be away from the excavation.

(g) *Hazardous atmospheres*—(1) *Testing and controls*. In addition to the requirements set forth in subparts D and E of this part (29 CFR 1926.50–1926.107) to prevent exposure to harmful levels of atmospheric contaminants and to assure acceptable atmospheric conditions, the following requirements shall apply:

(i) Where oxygen deficiency (atmospheres containing less than 19.5 percent oxygen) or a hazardous atmosphere exists or could reasonably be expected to exist, such as in excavations in landfill areas or excavations in areas where hazardous substances are stored nearby, the atmospheres in the excavation shall be tested before employees enter excavations greater than 4 feet (1.22 m) in depth.

(ii) Adequate precautions shall be taken to prevent employee exposure to atmospheres containing less than 19.5 percent oxygen and other hazardous

atmospheres. These precautions include providing proper respiratory protection or ventilation in accordance with subparts D and E of this part respectively.

(iii) Adequate precaution shall be taken such as providing ventilation, to prevent employee exposure to an atmosphere containing a concentration of a flammable gas in excess of 20 percent of the lower flammable limit of the gas.

(iv) When controls are used that are intended to reduce the level of atmospheric contaminants to acceptable levels, testing shall be conducted as often as necessary to ensure that the atmosphere remains safe.

(2) *Emergency rescue equipment.* (i) Emergency rescue equipment, such as breathing apparatus, a safety harness and line, or a basket stretcher, shall be readily available where hazardous atmospheric conditions exist or may reasonably be expected to develop during work in an excavation. This equipment shall be attended when in use.

(ii) Employees entering bell-bottom pier holes, or other similar deep and confined footing excavations, shall wear a harness with a life-line securely attached to it. The lifeline shall be separate from any line used to handle materials, and shall be individually attended at all times while the employee wearing the lifeline is in the excavation.

(h) *Protection from hazards associated with water accumulation.* (1) Employees shall not work in excavations in which there is accumulated water, or in excavations in which water is accumulating, unless adequate precautions have been taken to protect employees against the hazards posed by water accumulation. The precautions necessary to protect employees adequately vary with each situation, but could include special support or shield systems to protect from cave-ins, water removal to control the level of accumulating water, or use of a safety harness and lifeline.

(2) If water is controlled or prevented from accumulating by the use of water removal equipment, the water removal equipment and operations shall be monitored by a competent person to ensure proper operation.

(3) If excavation work interrupts the natural drainage of surface water (such as streams), diversion ditches, dikes, or other suitable means shall be used to prevent surface water from entering the excavation and to provide adequate drainage of the area adjacent to the excavation. Excavations subject to runoff from heavy rains will require an inspection by a competent person and compliance with paragraphs (h)(1) and (h)(2) of this section.

(i) *Stability of adjacent structures.* (1) Where the stability of adjoining buildings, walls, or other structures is endangered by excavation operations, support systems such as shoring, bracing, or underpinning shall be provided to ensure the stability of such structures for the protection of employees.

(2) Excavation below the level of the base or footing of any foundation or retaining wall that could be reasonably expected to pose a hazard to employees shall not be permitted except when:

(i) A support system, such as underpinning, is provided to ensure the safety of employees and the stability of the structure; or

(ii) The excavation is in stable rock; or

(iii) A registered professional engineer has approved the determination that the structure is sufficiently removed from the excavation so as to be unaffected by the excavation activity; or

(iv) A registered professional engineer has approved the determination that such excavation work will not pose a hazard to employees.

(3) Sidewalks, pavements, and appurtenant structure shall not be undermined unless a support system or another method of protection is provided to protect employees from the possible collapse of such structures.

(j) *Protection of employees from loose rock or soil.* (1) Adequate protection shall be provided to protect employees from loose rock or soil that could pose a hazard by falling or rolling from an excavation face. Such protection shall consist of scaling to remove loose material; installation of protective barricades at intervals as necessary on the face to stop and contain falling material; or other means that provide equivalent protection.

(2) Employees shall be protected from excavated or other materials or equipment that could pose a hazard by falling or rolling into excavations. Protection shall be provided by placing and keeping such materials or equipment at least 2 feet (.61 m) from the edge of excavations, or by the use of retaining devices that are sufficient to prevent materials or equipment from falling or rolling into excavations, or by a combination of both if necessary.

(k) *Inspections.* (1) Daily inspections of excavations, the adjacent areas, and protective systems shall be made by a competent person for evidence of a situation that could result in possible cave-ins, indications of failure of protective systems, hazardous atmospheres, or other hazardous conditions. An inspection shall be conducted by the competent person prior to the start of work and as needed throughout the shift. Inspections shall also be made after every rainstorm or other hazard increasing occurrence. These inspections are only required when employee exposure can be reasonably anticipated.

(2) Where the competent person finds evidence of a situation that could result in a possible cave-in, indications of failure of protective systems, hazardous atmospheres, or other hazardous conditions, exposed employees shall be removed from the hazardous area until the necessary precautions have been taken to ensure their safety.

(1) Walkways shall be provided where employees or equipment are required or permitted to cross over excavations. Guardrails which comply with §1926.502(b) shall be provided where walkways are 6 feet (1.8 m) or more above lower levels.

[54 FR 45959, Oct. 31, 1989, as amended by 59 FR 40730, Aug. 9, 1994]

§ 1926.652 Requirements for protective systems.

(a) *Protection of employees in excavations.* (1) Each employee in an excavation shall be protected from cave-ins by an adequate protective system designed in accordance with paragraph (b) or (c) of this section except when:

(i) Excavations are made entirely in stable rock; or

(ii) Excavations are less than 5 feet (1.52m) in depth and examination of the ground by a competent person provides no indication of a potential cave-in.

(2) Protective systems shall have the capacity to resist without failure all loads that are intended or could reasonably be expected to be applied or transmitted to the system.

(b) *Design of sloping and benching systems.* The slopes and configurations of sloping and benching systems shall be selected and constructed by the employer or his designee and shall be in accordance with the requirements of paragraph (b)(1); or, in the alternative, paragraph (b)(2); or, in the alternative, paragraph (b)(3), or, in the alternative, paragraph (b)(4), as follows:

(1) *Option (1)—Allowable configurations and slopes.* (i) Excavations shall be sloped at an angle not steeper than one and one-half horizontal to one vertical (34 degrees measured from the horizontal), unless the employer uses one of the other options listed below.

(ii) Slopes specified in paragraph (b)(1)(i) of this section, shall be excavated to form configurations that are in accordance with the slopes shown for Type C soil in appendix B to this subpart.

(2) *Option (2)—Determination of slopes and configurations using Appendices A and B.* Maximum allowable slopes, and allowable configurations for sloping and benching systems, shall be determined in accordance with the conditions and requirements set forth in appendices A and B to this subpart.

(3) *Option (3)—Designs using other tabulated data.* (i) Designs of sloping or benching systems shall be selected from and be in accordance with tabulated data, such as tables and charts.

(ii) The tabulated data shall be in written form and shall include all of the following:

(A) Identification of the parameters that affect the selection of a sloping or benching system drawn from such data;

(B) Identification of the limits of use of the data, to include the magnitude and configuration of slopes determined to be safe;

(C) Explanatory information as may be necessary to aid the user in making a correct selection of a protective system from the data.

(iii) At least one copy of the tabulated data which identifies the registered professional engineer who approved the data, shall be maintained at the jobsite during construction of the protective system. After that time the data may be stored off the jobsite, but a copy of the data shall be made available to the Secretary upon request.

(4) *Option (4)—Design by a registered professional engineer.* (i) Sloping and benching systems not utilizing Option (1) or Option (2) or Option (3) under paragraph (b) of this section shall be approved by a registered professional engineer.

(ii) Designs shall be in written form and shall include at least the following:

(A) The magnitude of the slopes that were determined to be safe for the particular project;

(B) The configurations that were determined to be safe for the particular project; and

(C) The identity of the registered professional engineer approving the design.

(iii) At least one copy of the design shall be maintained at the jobsite while the slope is being constructed. After that time the design need not be at the jobsite, but a copy shall be made available to the Secretary upon request.

(c) *Design of support systems, shield systems, and other protective systems.* Designs of support systems shield systems, and other protective systems shall be selected and constructed by the employer or his designee and shall be in accordance with the requirements of paragraph (c)(1); or, in the alternative, paragraph (c)(2); or, in the alternative, paragraph (c)(3); or, in the alternative, paragraph (c)(4) as follows:

(1) *Option (1)—Designs using appendices A, C and D.* Designs for timber shoring in trenches shall be determined in accordance with the conditions and requirements set forth in appendices A and C to this subpart. Designs for aluminum hydraulic shoring shall be in accordance with paragraph (c)(2) of this section, but if manufacturer's tabulated data cannot be utilized, designs shall be in accordance with appendix D.

(2) *Option (2)—Designs Using Manufacturer's Tabulated Data.* (i) Design of support systems, shield systems, or other

protective systems that are drawn from manufacturer's tabulated data shall be in accordance with all specifications, recommendations, and limitations issued or made by the manufacturer.

(ii) Deviation from the specifications, recommendations, and limitations issued or made by the manufacturer shall only be allowed after the manufacturer issues specific written approval.

(iii) Manufacturer's specifications, recommendations, and limitations, and manufacturer's approval to deviate from the specifications, recommendations, and limitations shall be in written form at the jobsite during construction of the protective system. After that time this data may be stored off the jobsite, but a copy shall be made available to the Secretary upon request.

(3) *Option (3)—Designs using other tabulated data.* (i) Designs of support systems, shield systems, or other protective systems shall be selected from and be in accordance with tabulated data, such as tables and charts.

(ii) The tabulated data shall be in written form and include all of the following:

(A) Identification of the parameters that affect the selection of a protective system drawn from such data;

(B) Identification of the limits of use of the data;

(C) Explanatory information as may be necessary to aid the user in making a correct selection of a protective system from the data.

(iii) At least one copy of the tabulated data, which identifies the registered professional engineer who approved the data, shall be maintained at the jobsite during construction of the protective system. After that time the data may be stored off the jobsite, but a copy of the data shall be made available to the Secretary upon request.

(4) *Option (4)—Design by a registered professional engineer.* (i) Support systems, shield systems, and other protective systems not utilizing Option 1, Option 2 or Option 3, above, shall be approved by a registered professional engineer.

(ii) Designs shall be in written form and shall include the following:

(A) A plan indicating the sizes, types, and configurations of the materials to be used in the protective system; and

(B) The identity of the registered professional engineer approving the design.

(iii) At least one copy of the design shall be maintained at the jobsite during construction of the protective system. After that time, the design may be stored off the jobsite, but a copy of the design shall be made available to the Secretary upon request.

(d) *Materials and equipment.* (1) Materials and equipment used for protective systems shall be free from damage or defects that might impair their proper function.

(2) Manufactured materials and equipment used for protective systems shall be used and maintained in a manner that is consistent with the recommendations of the manufacturer, and in a manner that will prevent employee exposure to hazards.

(3) When material or equipment that is used for protective systems is damaged, a competent person shall examine the material or equipment and evaluate its suitability for continued use. If the competent person cannot assure the material or equipment is able to support the intended loads or is otherwise suitable for safe use, then such material or equipment shall be removed from service, and shall be evaluated and approved by a registered professional engineer before being returned to service.

(e) *Installation and removal of support*—(1) *General.* (i) Members of support systems shall be securely connected together to prevent sliding, falling, kickouts, or other predictable failure.

(ii) Support systems shall be installed and removed in a manner that protects employees from cave-ins, structural collapses, or from being struck by members of the support system.

(iii) Individual members of support systems shall not be subjected to loads exceeding those which those members were designed to withstand.

(iv) Before temporary removal of individual members begins, additional precautions shall be taken to ensure the safety of employees, such as in-

stalling other structural members to carry the loads imposed on the support system.

(v) Removal shall begin at, and progress from, the bottom of the excavation. Members shall be released slowly so as to note any indication of possible failure of the remaining members of the structure or possible cave-in of the sides of the excavation.

(vi) Backfilling shall progress together with the removal of support systems from excavations.

(2) *Additional requirements for support systems for trench excavations.* (i) Excavation of material to a level no greater than 2 feet (.61 m) below the bottom of the members of a support system shall be permitted, but only if the system is designed to resist the forces calculated for the full depth of the trench, and there are no indications while the trench is open of a possible loss of soil from behind or below the bottom of the support system.

(ii) Installation of a support system shall be closely coordinated with the excavation of trenches.

(f) *Sloping and benching systems.* Employees shall not be permitted to work on the faces of sloped or benched excavations at levels above other employees except when employees at the lower levels are adequately protected from the hazard of falling, rolling, or sliding material or equipment.

(g) *Shield systems*—(1) *General.* (i) Shield systems shall not be subjected to loads exceeding those which the system was designed to withstand.

(ii) Shields shall be installed in a manner to restrict lateral or other hazardous movement of the shield in the event of the application of sudden lateral loads.

(iii) Employees shall be protected from the hazard of cave-ins when entering or exiting the areas protected by shields.

(iv) Employees shall not be allowed in shields when shields are being installed, removed, or moved vertically.

(2) *Additional requirement for shield systems used in trench excavations.* Excavations of earth material to a level no greater than 2 feet (.61 m) below the bottom of a shield shall be permitted, but only if the shield is designed to resist the forces calculated for the full

depth of the trench, and there are no indications while the trench is open of a possible loss of soil from behind or below the bottom of the shield.

APPENDIX A TO SUBPART P OF PART
1926—SOIL CLASSIFICATION

(a) *Scope and application*—(1) *Scope*. This appendix describes a method of classifying soil and rock deposits based on site and environmental conditions, and on the structure and composition of the earth deposits. The appendix contains definitions, sets forth requirements, and describes acceptable visual and manual tests for use in classifying soils.

(2) *Application*. This appendix applies when a sloping or benching system is designed in accordance with the requirements set forth in §1926.652(b)(2) as a method of protection for employees from cave-ins. This appendix also applies when timber shoring for excavations is designed as a method of protection from cave-ins in accordance with appendix C to subpart P of part 1926, and when aluminum hydraulic shoring is designed in accordance with appendix D. This appendix also applies if other protective systems are designed and selected for use from data prepared in accordance with the requirements set forth in §1926.652(c), and the use of the data is predicated on the use of the soil classification system set forth in this appendix.

(b) *Definitions*. The definitions and examples given below are based on, in whole or in part, the following: American Society for Testing Materials (ASTM) Standards D653-85 and D2488; The Unified Soils Classification System, The U.S. Department of Agriculture (USDA) Textural Classification Scheme; and The National Bureau of Standards Report BSS-121.

Cemented soil means a soil in which the particles are held together by a chemical agent, such as calcium carbonate, such that a hand-size sample cannot be crushed into powder or individual soil particles by finger pressure.

Cohesive soil means clay (fine grained soil), or soil with a high clay content, which has cohesive strength. Cohesive soil does not crumble, can be excavated with vertical sideslopes, and is plastic when moist. Cohesive soil is hard to break up when dry, and exhibits significant cohesion when submerged. Cohesive soils include clayey silt, sandy clay, silty clay, clay and organic clay.

Dry soil means soil that does not exhibit visible signs of moisture content.

Fissured means a soil material that has a tendency to break along definite planes of fracture with little resistance, or a material that exhibits open cracks, such as tension cracks, in an exposed surface.

Granular soil means gravel, sand, or silt, (coarse grained soil) with little or no clay content. Granular soil has no cohesive

strength. Some moist granular soils exhibit apparent cohesion. Granular soil cannot be molded when moist and crumbles easily when dry.

Layered system means two or more distinctly different soil or rock types arranged in layers. Micaceous seams or weakened planes in rock or shale are considered layered.

Moist soil means a condition in which a soil looks and feels damp. Moist cohesive soil can easily be shaped into a ball and rolled into small diameter threads before crumbling. Moist granular soil that contains some cohesive material will exhibit signs of cohesion between particles.

Plastic means a property of a soil which allows the soil to be deformed or molded without cracking, or appreciable volume change.

Saturated soil means a soil in which the voids are filled with water. Saturation does not require flow. Saturation, or near saturation, is necessary for the proper use of instruments such as a pocket penetrometer or shear vane.

Soil classification system means, for the purpose of this subpart, a method of categorizing soil and rock deposits in a hierarchy of Stable Rock, Type A, Type B, and Type C, in decreasing order of stability. The categories are determined based on an analysis of the properties and performance characteristics of the deposits and the environmental conditions of exposure.

Stable rock means natural solid mineral matter that can be excavated with vertical sides and remain intact while exposed.

Submerged soil means soil which is underwater or is free seeping.

Type A means cohesive soils with an unconfined compressive strength of 1.5 ton per square foot (tsf) (144 kPa) or greater. Examples of cohesive soils are: clay, silty clay, sandy clay, clay loam and, in some cases, silty clay loam and sandy clay loam. Cemented soils such as caliche and hardpan are also considered Type A. However, no soil is Type A if:

- (i) The soil is fissured; or
- (ii) The soil is subject to vibration from heavy traffic, pile driving, or similar effects; or
- (iii) The soil has been previously disturbed; or
- (iv) The soil is part of a sloped, layered system where the layers dip into the excavation on a slope of four horizontal to one vertical (4H:1V) or greater; or
- (v) The material is subject to other factors that would require it to be classified as a less stable material.

Type B means:

- (i) Cohesive soil with an unconfined compressive strength greater than 0.5 tsf (48 kPa) but less than 1.5 tsf (144 kPa); or
- (ii) Granular cohesionless soils including: angular gravel (similar to crushed rock),

silt, silt loam, sandy loam and, in some cases, silty clay loam and sandy clay loam.

(iii) Previously disturbed soils except those which would otherwise be classed as Type C soil.

(iv) Soil that meets the unconfined compressive strength or cementation requirements for Type A, but is fissured or subject to vibration; or

(v) Dry rock that is not stable; or

(vi) Material that is part of a sloped, layered system where the layers dip into the excavation on a slope less steep than four horizontal to one vertical (4H:1V), but only if the material would otherwise be classified as Type B.

Type C means:

(i) Cohesive soil with an unconfined compressive strength of 0.5 tsf (48 kPa) or less; or

(ii) Granular soils including gravel, sand, and loamy sand; or

(iii) Submerged soil or soil from which water is freely seeping; or

(iv) Submerged rock that is not stable, or

(v) Material in a sloped, layered system where the layers dip into the excavation or a slope of four horizontal to one vertical (4H:1V) or steeper.

Unconfined compressive strength means the load per unit area at which a soil will fail in compression. It can be determined by laboratory testing, or estimated in the field using a pocket penetrometer, by thumb penetration tests, and other methods.

Wet soil means soil that contains significantly more moisture than moist soil, but in such a range of values that cohesive material will slump or begin to flow when vibrated. Granular material that would exhibit cohesive properties when moist will lose those cohesive properties when wet.

(c) *Requirements*—(1) *Classification of soil and rock deposits.* Each soil and rock deposit shall be classified by a competent person as Stable Rock, Type A, Type B, or Type C in accordance with the definitions set forth in paragraph (b) of this appendix.

(2) *Basis of classification.* The classification of the deposits shall be made based on the results of at least one visual and at least one manual analysis. Such analyses shall be conducted by a competent person using tests described in paragraph (d) below, or in other recognized methods of soil classification and testing such as those adopted by the American Society for Testing Materials, or the U.S. Department of Agriculture textural classification system.

(3) *Visual and manual analyses.* The visual and manual analyses, such as those noted as being acceptable in paragraph (d) of this appendix, shall be designed and conducted to provide sufficient quantitative and qualitative information as may be necessary to identify properly the properties, factors, and conditions affecting the classification of the deposits.

(4) *Layered systems.* In a layered system, the system shall be classified in accordance with its weakest layer. However, each layer may be classified individually where a more stable layer lies under a less stable layer.

(5) *Reclassification.* If, after classifying a deposit, the properties, factors, or conditions affecting its classification change in any way, the changes shall be evaluated by a competent person. The deposit shall be reclassified as necessary to reflect the changed circumstances.

(d) *Acceptable visual and manual tests*—(1) *Visual tests.* Visual analysis is conducted to determine qualitative information regarding the excavation site in general, the soil adjacent to the excavation, the soil forming the sides of the open excavation, and the soil taken as samples from excavated material.

(i) Observe samples of soil that are excavated and soil in the sides of the excavation. Estimate the range of particle sizes and the relative amounts of the particle sizes. Soil that is primarily composed of fine-grained material is cohesive material. Soil composed primarily of coarse-grained sand or gravel is granular material.

(ii) Observe soil as it is excavated. Soil that remains in clumps when excavated is cohesive. Soil that breaks up easily and does not stay in clumps is granular.

(iii) Observe the side of the opened excavation and the surface area adjacent to the excavation. Crack-like openings such as tension cracks could indicate fissured material. If chunks of soil spall off a vertical side, the soil could be fissured. Small spalls are evidence of moving ground and are indications of potentially hazardous situations.

(iv) Observe the area adjacent to the excavation and the excavation itself for evidence of existing utility and other underground structures, and to identify previously disturbed soil.

(v) Observe the opened side of the excavation to identify layered systems. Examine layered systems to identify if the layers slope toward the excavation. Estimate the degree of slope of the layers.

(vi) Observe the area adjacent to the excavation and the sides of the opened excavation for evidence of surface water, water seeping from the sides of the excavation, or the location of the level of the water table.

(vii) Observe the area adjacent to the excavation and the area within the excavation for sources of vibration that may affect the stability of the excavation face.

(2) *Manual tests.* Manual analysis of soil samples is conducted to determine quantitative as well as qualitative properties of soil and to provide more information in order to classify soil properly.

(i) *Plasticity.* Mold a moist or wet sample of soil into a ball and attempt to roll it into threads as thin as 1/8-inch in diameter. Cohesive material can be successfully rolled into

threads without crumbling. For example, if at least a two inch (50 mm) length of 1/8-inch thread can be held on one end without tearing, the soil is cohesive.

(ii) *Dry strength.* If the soil is dry and crumbles on its own or with moderate pressure into individual grains or fine powder, it is granular (any combination of gravel, sand, or silt). If the soil is dry and falls into clumps which break up into smaller clumps, but the smaller clumps can only be broken up with difficulty, it may be clay in any combination with gravel, sand or silt. If the dry soil breaks into clumps which do not break up into small clumps and which can only be broken with difficulty, and there is no visual indication the soil is fissured, the soil may be considered unfissured.

(iii) *Thumb penetration.* The thumb penetration test can be used to estimate the unconfined compressive strength of cohesive soils. (This test is based on the thumb penetration test described in American Society for Testing and Materials (ASTM) Standard designation D2488—"Standard Recommended Practice for Description of Soils (Visual—Manual Procedure).") Type A soils with an unconfined compressive strength of 1.5 tsf can be readily indented by the thumb; however, they can be penetrated by the thumb only with very great effort. Type C soils with an unconfined compressive strength of 0.5 tsf can be easily penetrated several inches by the thumb, and can be molded by light finger pressure. This test should be conducted on an undisturbed soil sample, such as a large clump of spoil, as soon as practicable after excavation to keep to a minimum the effects of exposure to drying influences. If the excavation is later exposed to wetting influences (rain, flooding), the classification of the soil must be changed accordingly.

(iv) *Other strength tests.* Estimates of unconfined compressive strength of soils can also be obtained by use of a pocket penetrometer or by using a hand-operated shear vane.

(v) *Drying test.* The basic purpose of the drying test is to differentiate between cohesive material with fissures, unfissured cohesive material, and granular material. The procedure for the drying test involves drying a sample of soil that is approximately one inch thick (2.54 cm) and six inches (15.24 cm) in diameter until it is thoroughly dry:

(A) If the sample develops cracks as it dries, significant fissures are indicated.

(B) Samples that dry without cracking are to be broken by hand. If considerable force is necessary to break a sample, the soil has significant cohesive material content. The soil can be classified as a unfissured cohesive material and the unconfined compressive strength should be determined.

(C) If a sample breaks easily by hand, it is either a fissured cohesive material or a granular material. To distinguish between

the two, pulverize the dried clumps of the sample by hand or by stepping on them. If the clumps do not pulverize easily, the material is cohesive with fissures. If they pulverize easily into very small fragments, the material is granular.

APPENDIX B TO SUBPART P OF PART 1926—SLOPING AND BENCHING

(a) *Scope and application.* This appendix contains specifications for sloping and benching when used as methods of protecting employees working in excavations from cave-ins. The requirements of this appendix apply when the design of sloping and benching protective systems is to be performed in accordance with the requirements set forth in §1926.652(b)(2).

(b) *Definitions.*

Actual slope means the slope to which an excavation face is excavated.

Distress means that the soil is in a condition where a cave-in is imminent or is likely to occur. Distress is evidenced by such phenomena as the development of fissures in the face of or adjacent to an open excavation; the subsidence of the edge of an excavation; the slumping of material from the face or the bulging or heaving of material from the bottom of an excavation; the spalling of material from the face of an excavation; and raveling, i.e., small amounts of material such as pebbles or little clumps of material suddenly separating from the face of an excavation and trickling or rolling down into the excavation.

Maximum allowable slope means the steepest incline of an excavation face that is acceptable for the most favorable site conditions as protection against cave-ins, and is expressed as the ratio of horizontal distance to vertical rise (H:V).

Short term exposure means a period of time less than or equal to 24 hours that an excavation is open.

(c) *Requirements*—(1) *Soil classification.* Soil and rock deposits shall be classified in accordance with appendix A to subpart P of part 1926.

(2) *Maximum allowable slope.* The maximum allowable slope for a soil or rock deposit shall be determined from Table B-1 of this appendix.

(3) *Actual slope.* (i) The actual slope shall not be steeper than the maximum allowable slope.

(ii) The actual slope shall be less steep than the maximum allowable slope, when there are signs of distress. If that situation occurs, the slope shall be cut back to an actual slope which is at least 1/2 horizontal to one vertical (1/2H:1V) less steep than the maximum allowable slope.

(iii) When surcharge loads from stored material or equipment, operating equipment, or traffic are present, a competent person shall

determine the degree to which the actual slope must be reduced below the maximum allowable slope, and shall assure that such reduction is achieved. Surcharge loads from

adjacent structures shall be evaluated in accordance with §1926.651(i).

(4) *Configurations.* Configurations of sloping and benching systems shall be in accordance with Figure B-1.

TABLE B-1
MAXIMUM ALLOWABLE SLOPES

SOIL OR ROCK TYPE	MAXIMUM ALLOWABLE SLOPES (H:V) [1] FOR EXCAVATIONS LESS THAN 20 FEET DEEP [3]
STABLE ROCK TYPE A [2] TYPE B TYPE C	VERTICAL (90°) 3/4 : 1 (53°) 1:1 (45°) 1½ : 1 (34°)

NOTES:

1. Numbers shown in parentheses next to maximum allowable slopes are angles expressed in degrees from the horizontal. Angles have been rounded off.
2. A short-term maximum allowable slope of 1/2H:1V (63°) is allowed in excavations in Type A soil that are 12 feet (3.67 m) or less in depth. Short-term maximum allowable slopes for excavations greater than 12 feet (3.67 m) in depth shall be 3/4H:1V (53°).
3. Sloping or benching for excavations greater than 20 feet deep shall be designed by a registered professional engineer.

Figure B-1

Slope Configurations

(All slopes stated below are in the horizontal to vertical ratio)

B-1.1 Excavations made in Type A soil.

1. All simple slope excavation 20 feet or less in depth shall have a maximum allowable slope of ¾:1.

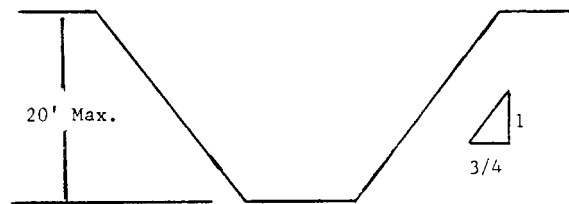

SIMPLE SLOPE—GENERAL

Exception: Simple slope excavations which are open 24 hours or less (short term) and which are 12 feet or less in depth shall have a maximum allowable slope of ½:1.

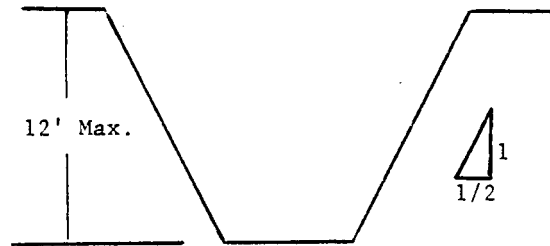

SIMPLE SLOPE—SHORT TERM

2. All benched excavations 20 feet or less in depth shall have a maximum allowable slope of $\frac{3}{4}$ to 1 and maximum bench dimensions as follows:

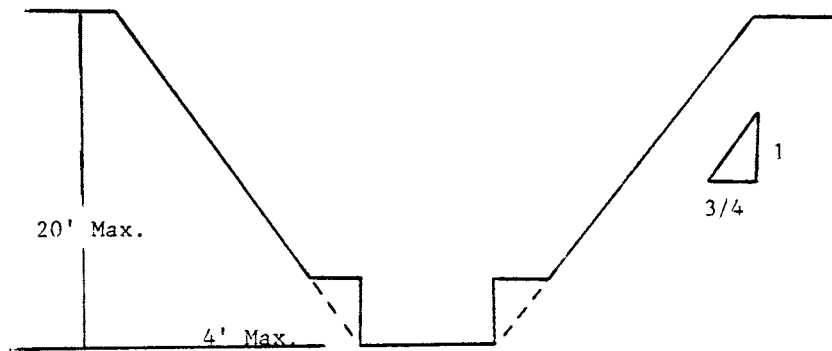

SIMPLE BENCH

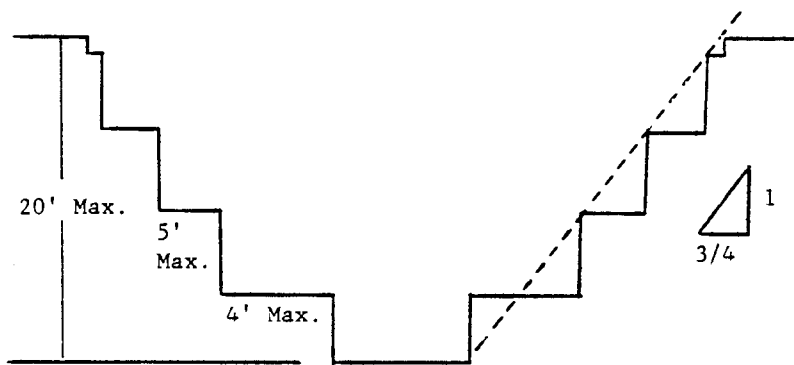

MULTIPLE BENCH

3. All excavations 8 feet or less in depth which have unsupported vertically sided lower portions shall have a maximum vertical side of $3\frac{1}{2}$ feet.

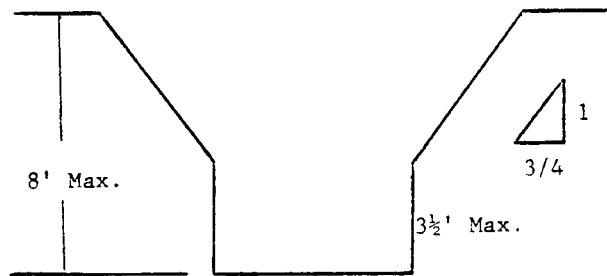

UNSUPPORTED VERTICALLY SIDED LOWER PORTION—MAXIMUM 8 FEET IN DEPTH

All excavations more than 8 feet but not more than 12 feet in depth which unsupported vertically sided lower portions shall have a maximum allowable slope of 1:1 and a maximum vertical side of 3½ feet.

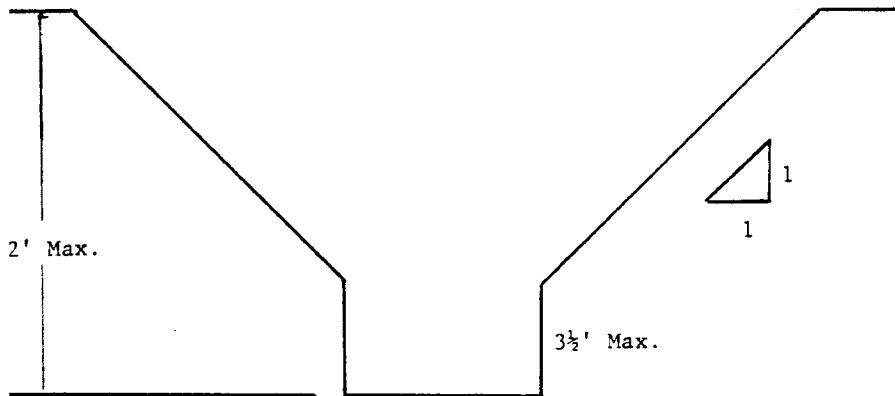

UNSUPPORTED VERTICALLY SIDED LOWER PORTION—MAXIMUM 12 FEET IN DEPTH

All excavations 20 feet or less in depth which have vertically sided lower portions that are supported or shielded shall have a maximum allowable slope of ¾:1. The support or shield system must extend at least 18 inches above the top of the vertical side.

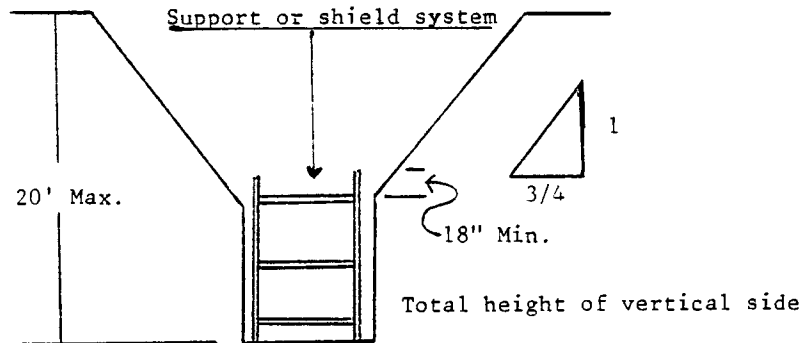

SUPPORTED OR SHIELDED VERTICALLY SIDED LOWER PORTION

4. All other simple slope, compound slope, and vertically sided lower portion excavations shall be in accordance with the other options permitted under §1926.652(b).

B-1.2 Excavations Made in Type B Soil

1. All simple slope excavations 20 feet or less in depth shall have a maximum allowable slope of 1:1.

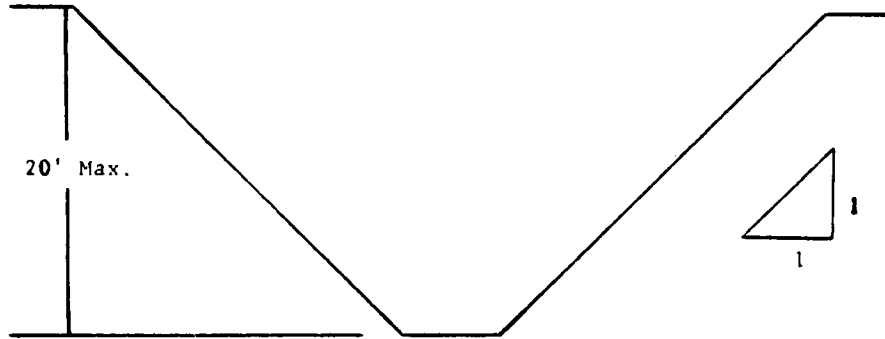

SIMPLE SLOPE

2. All benched excavations 20 feet or less in depth shall have a maximum allowable slope of 1:1 and maximum bench dimensions as follows:

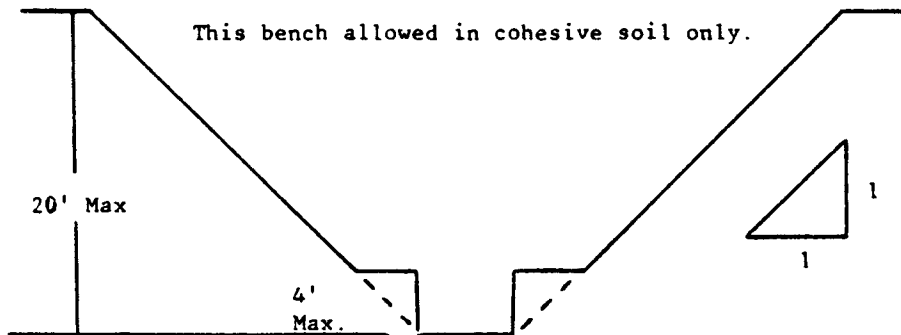

SINGLE BENCH

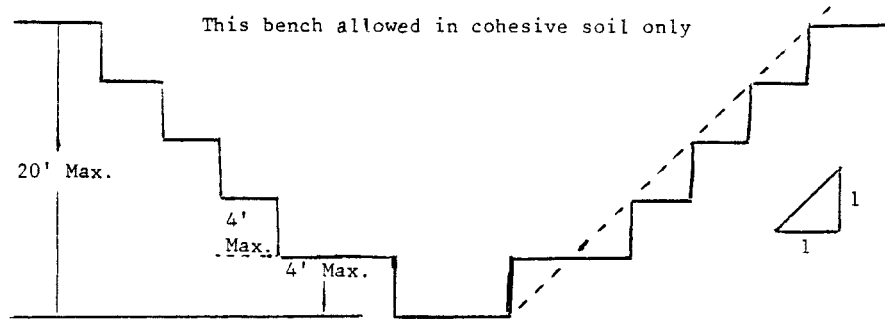

MULTIPLE BENCH

3. All excavations 20 feet or less in depth which have vertically sided lower portions shall be shielded or supported to a height at least 18 inches above the top of the vertical side. All such excavations shall have a maximum allowable slope of 1:1.

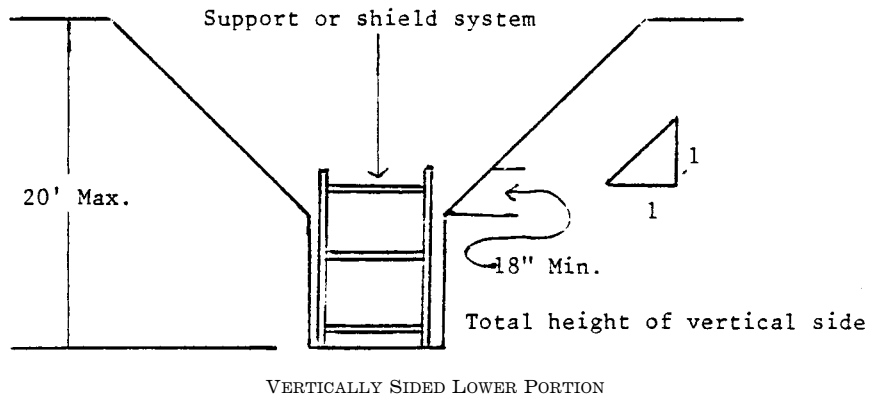

4. All other sloped excavations shall be in accordance with the other options permitted in §1926.652(b).

B-1.3 Excavations Made in Type C Soil

1. All simple slope excavations 20 feet or less in depth shall have a maximum allowable slope of 1½:1.

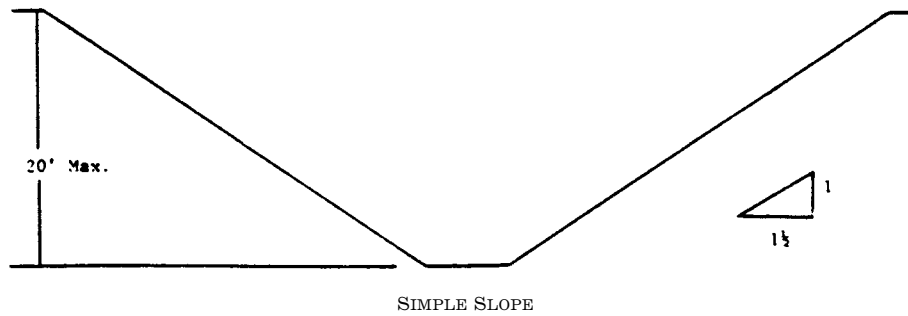

2. All excavations 20 feet or less in depth which have vertically sided lower portions shall be shielded or supported to a height at least 18 inches above the top of the vertical side. All such excavations shall have a maximum allowable slope of 1½:1.

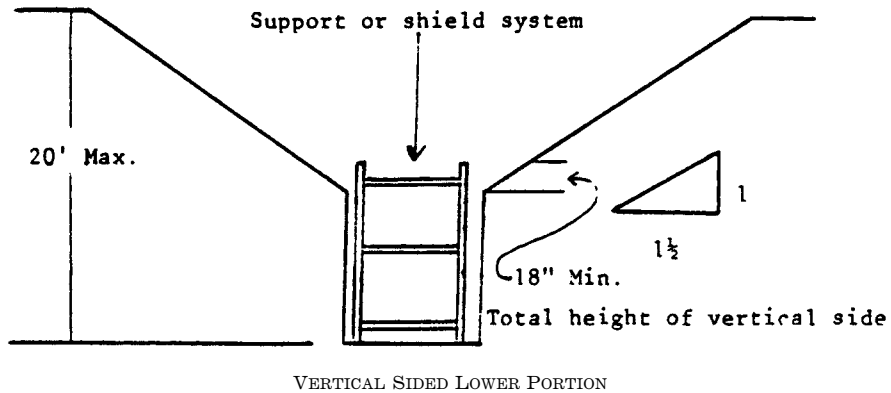

3. All other sloped excavations shall be in accordance with the other options permitted in §1926.652(b).

B-1.4 Excavations Made in Layered Soils

1. All excavations 20 feet or less in depth made in layered soils shall have a maximum allowable slope for each layer as set forth below.

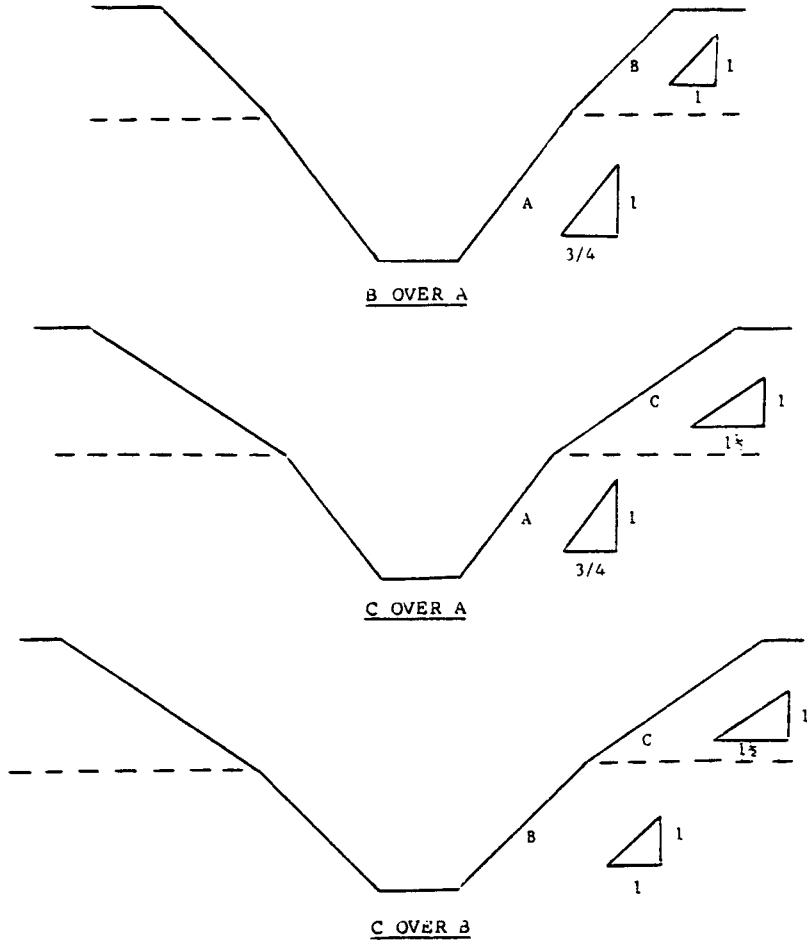

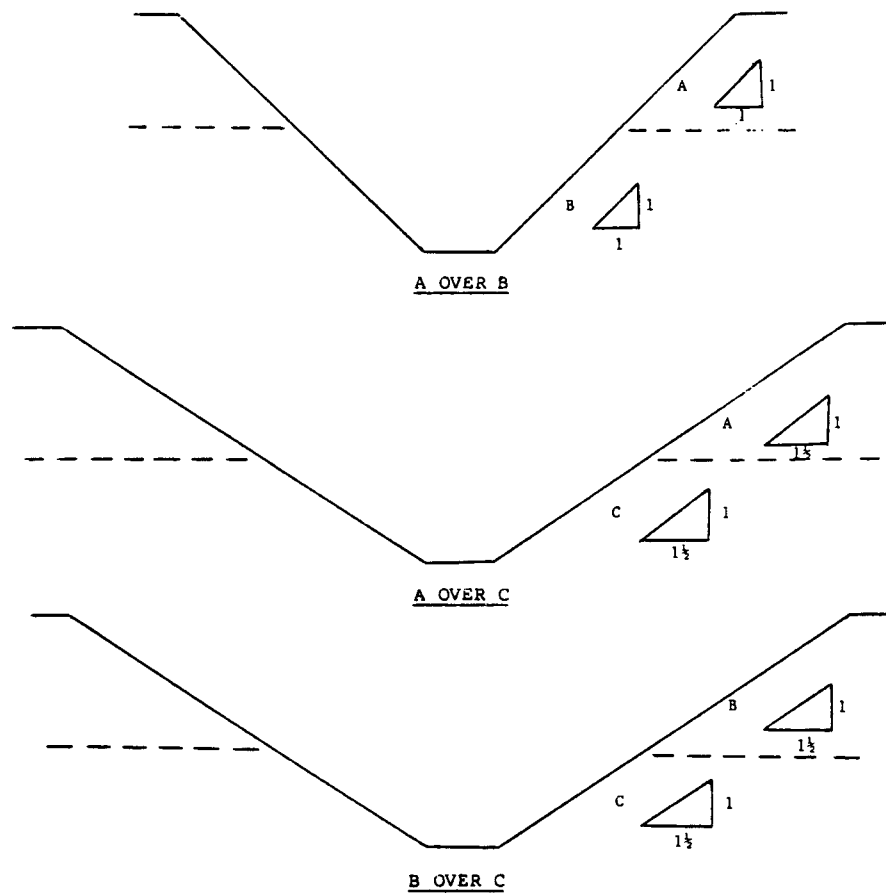

2. All other sloped excavations shall be in accordance with the other options permitted in §1926.652(b).

APPENDIX C TO SUBPART P OF PART 1926—TIMBER SHORING FOR TRENCHES

(a) *Scope.* This appendix contains information that can be used timber shoring is provided as a method of protection from cave-ins in trenches that do not exceed 20 feet (6.1 m) in depth. This appendix must be used when design of timber shoring protective systems is to be performed in accordance with §1926.652(c)(1). Other timber shoring configurations; other systems of support such as hydraulic and pneumatic systems; and other protective systems such as sloping, benching, shielding, and freezing systems must be designed in accordance with the requirements set forth in §1926.652(b) and §1926.652(c).

(b) *Soil Classification.* In order to use the data presented in this appendix, the soil type or types in which the excavation is made must first be determined using the soil classification method set forth in appendix A of subpart P of this part.

(c) *Presentation of Information.* Information is presented in several forms as follows:

(1) Information is presented in tabular form in Tables C-1.1, C-1.2, and C-1.3, and Tables C-2.1, C-2.2 and C-2.3 following paragraph (g) of the appendix. Each table presents the minimum sizes of timber members to use in a shoring system, and each table contains data only for the particular soil type in which the excavation or portion of

the excavation is made. The data are arranged to allow the user the flexibility to select from among several acceptable configurations of members based on varying the horizontal spacing of the crossbraces. Stable rock is exempt from shoring requirements and therefore, no data are presented for this condition.

(2) Information concerning the basis of the tabular data and the limitations of the data is presented in paragraph (d) of this appendix, and on the tables themselves.

(3) Information explaining the use of the tabular data is presented in paragraph (e) of this appendix.

(4) Information illustrating the use of the tabular data is presented in paragraph (f) of this appendix.

(5) Miscellaneous notations regarding Tables C-1.1 through C-1.3 and Tables C-2.1 through C-2.3 are presented in paragraph (g) of this Appendix.

(d) *Basis and limitations of the data*—(1) *Dimensions of timber members.* (i) The sizes of the timber members listed in Tables C-1.1 through C-1.3 are taken from the National Bureau of Standards (NBS) report, "Recommended Technical Provisions for Construction Practice in Shoring and Sloping of Trenches and Excavations." In addition, where NBS did not recommend specific sizes of members, member sizes are based on an analysis of the sizes required for use by existing codes and on empirical practice.

(ii) The required dimensions of the members listed in Tables C-1.1 through C-1.3 refer to actual dimensions and not nominal dimensions of the timber. Employers wanting to use nominal size shoring are directed to Tables C-2.1 through C-2.3, or have this choice under §1926.652(c)(3), and are referred to The Corps of Engineers, The Bureau of Reclamation or data from other acceptable sources.

(2) *Limitation of application.* (i) It is not intended that the timber shoring specification apply to every situation that may be experienced in the field. These data were developed to apply to the situations that are most commonly experienced in current trenching practice. Shoring systems for use in situations that are not covered by the data in this appendix must be designed as specified in §1926.652(c).

(ii) When any of the following conditions are present, the members specified in the tables are not considered adequate. Either an alternate timber shoring system must be designed or another type of protective system designed in accordance with §1926.652.

(A) When loads imposed by structures or by stored material adjacent to the trench weigh in excess of the load imposed by a two-foot soil surcharge. The term "adjacent" as used here means the area within a horizontal distance from the edge of the trench equal to the depth of the trench.

(B) When vertical loads imposed on cross braces exceed a 240-pound gravity load distributed on a one-foot section of the center of the crossbrace.

(C) When surcharge loads are present from equipment weighing in excess of 20,000 pounds.

(D) When only the lower portion of a trench is shored and the remaining portion of the trench is sloped or benched unless: The sloped portion is sloped at an angle less steep than three horizontal to one vertical; or the members are selected from the tables for use at a depth which is determined from the top of the overall trench, and not from the toe of the sloped portion.

(e) *Use of Tables.* The members of the shoring system that are to be selected using this information are the cross braces, the uprights, and the wales, where wales are required. Minimum sizes of members are specified for use in different types of soil. There are six tables of information, two for each soil type. The soil type must first be determined in accordance with the soil classification system described in appendix A to subpart P of part 1926. Using the appropriate table, the selection of the size and spacing of the members is then made. The selection is based on the depth and width of the trench where the members are to be installed and, in most instances, the selection is also based on the horizontal spacing of the crossbraces. Instances where a choice of horizontal spacing of crossbracing is available, the horizontal spacing of the crossbraces must be chosen by the user before the size of any member can be determined. When the soil type, the width and depth of the trench, and the horizontal spacing of the crossbraces are known, the size and vertical spacing of the crossbraces, the size and vertical spacing of the wales, and the size and horizontal spacing of the uprights can be read from the appropriate table.

(f) *Examples to Illustrate the Use of Tables C-1.1 through C-1.3.*

(1) *Example 1.*

A trench dug in Type A soil is 13 feet deep and five feet wide.

From *Table C-1.1*, for acceptable arrangements of timber can be used.

Arrangement #B1

Space 4×4 crossbraces at six feet horizontally and four feet vertically.

Wales are not required.

Space 3×8 uprights at six feet horizontally. This arrangement is commonly called "skip shoring."

Arrangement #B2

Space 4×6 crossbraces at eight feet horizontally and four feet vertically.

Space 8×8 wales at four feet vertically.

Space 2x6 uprights at four feet horizontally.

Arrangement #B3

Space 6x6 crossbraces at 10 feet horizontally and four feet vertically.

Space 8x10 wales at four feet vertically.

Space 2x6 uprights at five feet horizontally.

Arrangement #B4

Space 6x6 crossbraces at 12 feet horizontally and four feet vertically.

Space 10x10 wales at four feet vertically.

Spaces 3x8 uprights at six feet horizontally.

(2) Example 2.

A trench dug in Type B soil in 13 feet deep and five feet wide. From Table C-1.2 three acceptable arrangements of members are listed.

Arrangement #B1

Space 6x6 crossbraces at six feet horizontally and five feet vertically.

Space 8x8 wales at five feet vertically.

Space 2x6 uprights at two feet horizontally.

Arrangement #B2

Space 6x8 crossbraces at eight feet horizontally and five feet vertically.

Space 10x10 wales at five feet vertically.

Space 2x6 uprights at two feet horizontally.

Arrangement #B3

Space 8x8 crossbraces at 10 feet horizontally and five feet vertically.

Space 10x12 wales at five feet vertically.

Space 2x6 uprights at two feet vertically.

(3) Example 3.

A trench dug in Type C soil is 13 feet deep and five feet wide.

From Table C-1.3 two acceptable arrangements of members can be used.

Arrangement #B1

Space 8x8 crossbraces at six feet horizontally and five feet vertically.

Space 10x12 wales at five feet vertically.

Position 2x6 uprights as closely together as possible.

If water must be retained use special tongue and groove uprights to form tight sheeting.

Arrangement #B2

Space 8x10 crossbraces at eight feet horizontally and five feet vertically.

Space 12x12 wales at five feet vertically.

Position 2x6 uprights in a close sheeting configuration unless water pressure must be resisted. Tight sheeting must be used where water must be retained.

(4) Example 4.

A trench dug in Type C soil is 20 feet deep and 11 feet wide. The size and spacing of members for the section of trench that is over 15 feet in depth is determined using Table C-1.3. Only one arrangement of members is provided.

Space 8x10 crossbraces at six feet horizontally and five feet vertically.

Space 12x12 wales at five feet vertically.

Use 3x6 tight sheeting.

Use of Tables C-2.1 through C-2.3 would follow the same procedures.

(g) Notes for all Tables.

1. Member sizes at spacings other than indicated are to be determined as specified in §1926.652(c), "Design of Protective Systems."

2. When conditions are saturated or submerged use Tight Sheeting. Tight Sheeting refers to the use of specially-edged timber planks (e.g., tongue and groove) at least three inches thick, steel sheet piling, or similar construction that when driven or placed in position provide a tight wall to resist the lateral pressure of water and to prevent the loss of backfill material. Close Sheeting refers to the placement of planks side-by-side allowing as little space as possible between them.

3. All spacing indicated is measured center to center.

4. Wales to be installed with greater dimension horizontal.

5. If the vertical distance from the center of the lowest crossbrace to the bottom of the trench exceeds two and one-half feet, uprights shall be firmly embedded or a mudsill shall be used. Where uprights are embedded, the vertical distance from the center of the lowest crossbrace to the bottom of the trench shall not exceed 36 inches. When mudsills are used, the vertical distance shall not exceed 42 inches. Mudsills are wales that are installed at the toe of the trench side.

6. Trench jacks may be used in lieu of or in combination with timber crossbraces.

7. Placement of crossbraces. When the vertical spacing of crossbraces is four feet, place the top crossbrace no more than two feet below the top of the trench. When the vertical spacing of crossbraces is five feet, place the top crossbrace no more than 2.5 feet below the top of the trench.

TABLE C-1.1

TIMBER TRENCH SHORING -- MINIMUM TIMBER REQUIREMENTS *

SOIL TYPE A $P_a = 25 \times H + 72 \text{ psf}$ (2 ft Surcharge)

DEPTH OF TRENCH (FEET)	SIZE (ACTUAL) AND SPACING OF MEMBERS **											
	CROSS BRACES				WALES				UPRIGHTS			
	HORIZ. SPACING (FEET)		WIDTH OF TRENCH (FEET)		VERT. SPACING (FEET)		SIZE (IN)		VERT. SPACING (FEET)		MAXIMUM ALLOWABLE HORIZONTAL SPACING (FEET)	
5	UP TO 6	4X4	4X4	4X6	6X6	4	Not Req'd	---				
	UP TO 8	4X4	4X4	4X6	6X6	4	Not Req'd	---			2X6	2X8
10	UP TO 10	4X6	4X6	4X6	6X6	4	8X8	4			2X6	
	UP TO 12	4X6	4X6	6X6	6X6	4	8X8	4				2X6
10	UP TO 6	4X4	4X4	4X6	6X6	4	Not Req'd	---				
	UP TO 8	4X6	4X6	6X6	6X6	4	8X8	4		2X6		3X8
15	UP TO 10	6X6	6X5	6X6	6X8	4	8X10	4			2X6	
	UP TO 12	6X6	6X6	6X6	6X8	4	10X10	4				3X8
15	UP TO 6	6X6	6X6	6X6	6X8	4	6X8	4				
	UP TO 8	6X6	6X6	6X6	6X8	4	8X8	4				
20	UP TO 10	8X8	8X8	8X8	8X10	4	8X10	4			3X6	
	UP TO 12	8X8	8X8	8X8	8X10	4	10X10	4			3X6	
OVER 20	SEE NOTE 1.											

* Mixed oak or equivalent with a bending strength not less than 850 psi.

** Manufactured members of equivalent strength may be substituted for wood.

TABLE C-1.2

TIMBER TRENCH SHORING -- MINIMUM TIMBER REQUIREMENTS *

SOIL TYPE B P_a = 45 X H + 72 psf (2 ft. Surcharge)

DEPTH OF TRENCH (FEET)	SIZE (ACTUAL) AND SPACING OF MEMBERS**												
	CROSS BRACES				MALES				UPRIGHTS				
	HORIZ. SPACING (FEET)		WIDTH OF TRENCH (FEET)		VERT. SPACING (FEET)		SIZE (IN)		VERT. SPACING (FEET)		MAXIMUM ALLOWABLE HORIZONTAL SPACING (FEET)		
UP	TO	UP	TO	UP	TO	UP	TO	UP	TO	CLOSE	2	3	
5	UP	TO	4X6	4X6	6X6	6X6	6X6	6X6	5	6X8	5		
	UP	TO	6X6	6X6	6X8	6X8	6X8	6X8	5	8X10	5		2X6
	UP	TO	6X6	6X6	6X8	6X8	6X8	6X8	5	10X10	5		2X6
10	UP	TO											
	UP	TO	6X6	6X6	6X8	6X8	6X8	6X8	5	8X8	5		2X6
	UP	TO	6X8	6X8	8X8	8X8	8X8	8X8	5	10X10	5		2X6
15	UP	TO	8X8	8X8	8X8	8X8	8X8	8X10	5	10X12	5		2X6
	UP	TO											
	UP	TO	6X8	6X8	8X8	8X8	8X8	8X8	5	8X10	5	3X6	
20	UP	TO	8X8	8X8	8X8	8X8	8X10	10X10	5	10X12	5	3X6	
	UP	TO	8X10	8X10	8X10	8X10	10X10	10X10	5	12X12	5	3X6	
	UP	TO											
OVER	SEE NOTE 1												
20	SEE NOTE 1												

* Mixed oak or equivalent with a bending strength not less than 850 psi.
 ** Manufactured members of equivalent strength may be substituted for wood.

TABLE C-1.3

TIMBER TRENCH SHORING -- MINIMUM TIMBER REQUIREMENTS *
 SOIL TYPE C P_a = 80 X H + 72 psf (2 ft. Surcharge)

DEPTH OF TRENCH (FEET)	SIZE (ACTUAL) AND SPACING OF MEMBERS**											
	GROSS BRACES			WIDTH OF TRENCH (FEET)			VERT. SPACING (FEET)		SIZE (IN)	VERT. SPACING (FEET)	UPRIGHTS	
	HORIZ. SPACING (FEET)	UP TO 4	UP TO 6	UP TO 9	UP TO 12	UP TO 15	VERT. SPACING (FEET)	UP TO 15			CLOSE	MAXIMUM ALLOWABLE HORIZONTAL SPACING (FEET) (See Note 2)
5	UP TO 6	6X8	6X8	6X8	8X8	8X8	5	8X10	5	2X6		
TO 8		8X8	8X8	8X8	8X10	8X10	5	10X12	5	2X6		
UP TO 10		8X10	8X10	8X10	8X10	10X10	5	12X12	5	2X6		
See Note 1												
10	UP TO 6	8X8	8X8	8X8	8X8	8X10	5	10X12	5	2X6		
TO 8		8X10	8X10	8X10	8X10	10X10	5	12X12	5	2X6		
See Note 1												
See Note 1												
See Note 1												
15	UP TO 6	8X10	8X10	8X10	8X10	10X10	5	12X12	5	3X6		
TO 8												
See Note 1												
See Note 1												
See Note 1												
See Note 1												
OVER 20												

* Mixed Oak or equivalent with a bending strength not less than 850 psi.
 ** Manufactured members of equivalent strength may be substituted for wood.

TABLE C-2.1

TIMBER TRENCH SHORING -- MINIMUM TIMBER REQUIREMENTS *
 SOIL TYPE A P_a = 25 X H + 72 psf (2 ft. Surcharge)

DEPTH OF TRENCH (FEET)	SIZE (S4S) AND SPACING OF MEMBERS **																	
	CROSS BRACES						WALES			UPRIGHTS								
	HORIZ. SPACING (FEET)	WIDTH OF TRENCH (FEET)			VERT. SPACING (FEET)	SIZE (IN)	VERT. SPACING (FEET)	MAXIMUM ALLOWABLE HORIZONTAL SPACING (FEET)										
		UP TO 4	UP TO 6	UP TO 9				UP TO 12	UP TO 15	CLOSE	4	5	6	8				
5	UP TO 6	4X4	4X4	4X4	4X6	4	4X6	Not Req'd	4	4	4	4X6						
	UP TO 8	4X4	4X4	4X4	4X6	4	4X6	Not Req'd	4	4	4	4X6						4X8
10	UP TO 10	4X6	4X6	4X6	4X6	4	6X6	4	8X8	4	4	4X6						
	UP TO 12	4X6	4X6	4X6	4X6	4	6X6	4	8X8	4	4	4X6						4X6
10	UP TO 6	4X4	4X4	4X4	4X6	4	6X6	4	Not Req'd	4	4	4X6						4X10
	UP TO 8	4X6	4X6	4X6	4X6	4	6X6	4	6X8	4	4	4X6						
15	UP TO 10	6X6	6X6	6X6	6X6	4	6X6	4	8X8	4	4	4X6						
	UP TO 12	6X6	6X6	6X6	6X6	4	6X6	4	8X10	4	4	4X6						4X10
15	UP TO 6	6X6	6X6	6X6	6X6	4	6X6	4	6X8	4	4	3X6						
	UP TO 8	6X6	6X6	6X6	6X6	4	6X6	4	8X8	4	4	4X12						
20	UP TO 10	6X6	6X6	6X6	6X6	4	6X6	4	8X10	4	4	3X6						
	UP TO 12	6X6	6X6	6X6	6X6	4	6X6	4	8X12	4	4	3X6						4X12
OVER 20	SEE NOTE 1																	

* Douglas fir or equivalent with a bending strength not less than 1500 psi.
 ** Manufactured members of equivalent strength may be substituted for wood.

TABLE C-2.2

TIMBER TRENCH SHORING -- MINIMUM TIMBER REQUIREMENTS *
 SOIL TYPE B P_a = 45 X H + 72 psf (2 ft. Surcharge)

DEPTH OF TRENCH (FEET)	SIZE (S4S) AND SPACING OF MEMBERS **												
	CROSS BRACES						MALES			UPRIGHTS			
	HORIZ. SPACING (FEET)		WIDTH OF TRENCH (FEET)				VERT. SPACING (FEET)	SIZE (IN)	VERT. SPACING (FEET)	MAXIMUM ALLOWABLE HORIZONTAL SPACING (FEET)			
UP TO	TO	UP TO	UP TO	UP TO	UP TO	UP TO	UP TO	UP TO	CLOSE	2	3	4	6
5	UP TO	4X6	4X6	4X6	6X6	6X6	5	6X8	5				
TO	UP TO	4X6	4X6	6X6	6X6	6X6	5	8X8	5	3X8		4X8	4X12
10	UP TO	4X6	4X6	6X6	6X6	6X8	5	8X10	5		4X8		
	See Note 1												
10	UP TO	6X6	6X6	6X6	6X8	6X8	5	8X8	5	3X6	4X10		
TO	UP TO	6X8	6X8	6X8	8X8	8X8	5	10X10	5	3X6	4X10		
15	UP TO	6X8	6X8	8X8	8X8	8X8	5	10X12	5	3X6	4X10		
	See Note 1												
15	UP TO	6X8	6X8	6X8	8X8	8X8	5	8X10	5	4X6			
TO	UP TO	6X8	6X8	6X8	8X8	8X8	5	10X12	5	4X6			
20	UP TO	8X8	8X8	8X8	8X8	8X8	5	12X12	5	4X6			
	See Note 1												
OVER 20	SEE NOTE 1												

* Douglas fir or equivalent with a bending strength not less than 1500 psi.
 ** Manufactured members of equivalent strength may be substituted for wood.

TABLE C-2.3
 TIMBER TRENCH SHORING -- MINIMUM TIMBER REQUIREMENTS *
 SOIL TYPE C P_a = 80 X H + 72 psf (2 ft. Surcharge)

DEPTH OF TRENCH (FEET)	SIZE (S4S) AND SPACING OF MEMBERS **											UPRIGHTS	
	CROSS BRACES				MALES				VERT. SPACING (FEET)			MAXIMUM ALLOWABLE HORIZONTAL SPACING (FEET)	
	HORIZ. SPACING (FEET)		WIDTH OF TRENCH (FEET)		VERT. SPACING (FEET)		SIZE (IN)		VERT. SPACING (FEET)		CLOSE		
	UP TO	TO	UP TO	TO	UP TO	TO	UP TO	TO	UP TO	TO	UP TO	TO	
5 TO 10	UP TO 6	TO 10	6X6	6X6	6X6	6X6	8X8	8X8	5	5	5	3X6	
	UP TO 8	TO 10	6X6	6X6	6X6	8X8	8X8	5	5	5	3X6		
	UP TO 10	TO 10	6X6	6X6	8X8	8X8	8X8	5	5	5	3X6		
10 TO 15	UP TO 6	TO 10	6X8	6X8	6X8	8X8	8X8	8X8	5	5	5	4X6	
	UP TO 8	TO 10	8X8	8X8	8X8	8X8	8X8	5	5	5	4X6		
	See Note 1	See Note 1											
15 TO 20	UP TO 6	TO 10	8X8	8X8	8X8	8X10	8X10	8X10	5	5	5	4X6	
	UP TO 8	TO 10											
	UP TO 10	TO 10											
OVER 20	SEE NOTE 1												

* Douglas fir or equivalent with a bending strength not less than 1500 psi.
 ** Manufactured members of equivalent strength may be substituted for wood.

APPENDIX D TO SUBPART P OF PART 1926—ALUMINUM HYDRAULIC SHORING FOR TRENCHES

(a) *Scope.* This appendix contains information that can be used when aluminum hydraulic shoring is provided as a method of protection against cave-ins in trenches that

do not exceed 20 feet (6.1m) in depth. This appendix must be used when design of the aluminum hydraulic protective system cannot be performed in accordance with §1926.652(c)(2).

(b) *Soil Classification.* In order to use data presented in this appendix, the soil type or types in which the excavation is made must

first be determined using the soil classification method set forth in appendix A of subpart P of part 1926.

(c) *Presentation of Information.* Information is presented in several forms as follows:

(1) Information is presented in tabular form in Tables D-1.1, D-1.2, D-1.3 and E-1.4. Each table presents the maximum vertical and horizontal spacings that may be used with various aluminum member sizes and various hydraulic cylinder sizes. Each table contains data only for the particular soil type in which the excavation or portion of the excavation is made. Tables D-1.1 and D-1.2 are for vertical shores in Types A and B soil. Tables D-1.3 and D-1.4 are for horizontal waler systems in Types B and C soil.

(2) Information concerning the basis of the tabular data and the limitations of the data is presented in paragraph (d) of this appendix.

(3) Information explaining the use of the tabular data is presented in paragraph (e) of this appendix.

(4) Information illustrating the use of the tabular data is presented in paragraph (f) of this appendix.

(5) Miscellaneous notations (footnotes) regarding Table D-1.1 through D-1.4 are presented in paragraph (g) of this appendix.

(6) Figures, illustrating typical installations of hydraulic shoring, are included just prior to the Tables. The illustrations page is entitled "Aluminum Hydraulic Shoring; Typical Installations."

(d) *Basis and limitations of the data.* (1) Vertical shore rails and horizontal wales are those that meet the Section Modulus requirements in the D-1 Tables. Aluminum material is 6061-T6 or material of equivalent strength and properties.

(2) Hydraulic cylinders specifications. (i) 2-inch cylinders shall be a minimum 2-inch inside diameter with a minimum safe working capacity of no less than 18,000 pounds axial compressive load at maximum extension. Maximum extension is to include full range of cylinder extensions as recommended by product manufacturer.

(ii) 3-inch cylinders shall be a minimum 3-inch inside diameter with a safe working capacity of not less than 30,000 pounds axial compressive load at extensions as recommended by product manufacturer.

(3) Limitation of application.

(i) It is not intended that the aluminum hydraulic specification apply to every situation that may be experienced in the field. These data were developed to apply to the situations that are most commonly experienced in current trenching practice. Shoring systems for use in situations that are not covered by the data in this appendix must be otherwise designed as specified in §1926.652(c).

(ii) When any of the following conditions are present, the members specified in the Ta-

bles are not considered adequate. In this case, an alternative aluminum hydraulic shoring system or other type of protective system must be designed in accordance with §1926.652.

(A) When vertical loads imposed on cross braces exceed a 100 Pound gravity load distributed on a one foot section of the center of the hydraulic cylinder.

(B) When surcharge loads are present from equipment weighing in excess of 20,000 pounds.

(C) When only the lower portion or a trench is shored and the remaining portion of the trench is sloped or benched unless: The sloped portion is sloped at an angle less steep than three horizontal to one vertical; or the members are selected from the tables for use at a depth which is determined from the top of the overall trench, and not from the toe of the sloped portion.

(e) *Use of Tables D-1.1, D-1.2, D-1.3 and D-1.4.* The members of the shoring system that are to be selected using this information are the hydraulic cylinders, and either the vertical shores or the horizontal wales. When a waler system is used the vertical timber sheeting to be used is also selected from these tables. The Tables D-1.1 and D-1.2 for vertical shores are used in Type A and B soils that do not require sheeting. Type B soils that may require sheeting, and Type C soils that always require sheeting are found in the horizontal wale Tables D-1.3 and D-1.4. The soil type must first be determined in accordance with the soil classification system described in appendix A to subpart P of part 1926. Using the appropriate table, the selection of the size and spacing of the members is made. The selection is based on the depth and width of the trench where the members are to be installed. In these tables the vertical spacing is held constant at four feet on center. The tables show the maximum horizontal spacing of cylinders allowed for each size of wale in the waler system tables, and in the vertical shore tables, the hydraulic cylinder horizontal spacing is the same as the vertical shore spacing.

(f) *Example to Illustrate the Use of the Tables:*

(1) Example 1:

A trench dug in Type A soil is 6 feet deep and 3 feet wide. From Table D-1.1: Find vertical shores and 2 inch diameter cylinders spaced 8 feet on center (o.c.) horizontally and 4 feet on center (o.c.) vertically. (See Figures 1 & 3 for typical installations.)

(2) Example 2:

A trench is dug in Type B soil that does not require sheeting, 13 feet deep and 5 feet wide. From Table D-1.2: Find vertical shores and 2 inch diameter cylinders spaced 6.5 feet o.c. horizontally and 4 feet o.c. vertically. (See Figures 1 & 3 for typical installations.)

(3) A trench is dug in Type B soil that does not require sheeting, but does experience some minor raveling of the trench face. The

trench is 16 feet deep and 9 feet wide. From Table D-1.2: Find vertical shores and 2 inch diameter cylinder (with special oversleeves as designated by footnote #B2) spaced 5.5 feet o.c. horizontally and 4 feet o.c. vertically, plywood (per footnote (g)(7) to the D-1 Table) should be used behind the shores. (See Figures 2 & 3 for typical installations.)

(4) Example 4: A trench is dug in previously disturbed Type B soil, with characteristics of a Type C soil, and will require sheeting. The trench is 18 feet deep and 12 feet wide. 8 foot horizontal spacing between cylinders is desired for working space. From Table D-1.3: Find horizontal wale with a section modulus of 14.0 spaced at 4 feet o.c. vertically and 3 inch diameter cylinder spaced at 9 feet maximum o.c. horizontally. 3x12 timber sheeting is required at close spacing vertically. (See Figure 4 for typical installation.)

(5) Example 5: A trench is dug in Type C soil, 9 feet deep and 4 feet wide. Horizontal cylinder spacing in excess of 6 feet is desired for working space. From Table D-1.4: Find horizontal wale with a section modulus of 7.0 and 2 inch diameter cylinders spaced at 6.5 feet o.c. horizontally. Or, find horizontal wale with a 14.0 section modulus and 3 inch diameter cylinder spaced at 10 feet o.c. horizontally. Both wales are spaced 4 feet o.c. vertically. 3x12 timber sheeting is required at close spacing vertically. (See Figure 4 for typical installation.)

(g) *Footnotes, and general notes, for Tables D-1.1, D-1.2, D-1.3, and D-1.4.*

(1) For applications other than those listed in the tables, refer to §1926.652(c)(2) for use of manufacturer's tabulated data. For trench depths in excess of 20 feet, refer to §1926.652(c)(2) and §1926.652(c)(3).

(2) 2 inch diameter cylinders, at this width, shall have structural steel tube (3.5x3.5x0.1875) oversleeves, or structural oversleeves of manufacturer's specification, extending the full, collapsed length.

(3) Hydraulic cylinders capacities. (i) 2 inch cylinders shall be a minimum 2-inch inside diameter with a safe working capacity of not less than 18,000 pounds axial compressive load at maximum extension. Maximum extension is to include full range of cylinder extensions as recommended by product manufacturer.

(ii) 3-inch cylinders shall be a minimum 3-inch inside diameter with a safe work capacity of not less than 30,000 pounds axial compressive load at maximum extension. Maximum extension is to include full range of cylinder extensions as recommended by product manufacturer.

(4) All spacing indicated is measured center to center.

(5) Vertical shoring rails shall have a minimum section modulus of 0.40 inch.

(6) When vertical shores are used, there must be a minimum of three shores spaced equally, horizontally, in a group.

(7) Plywood shall be 1.125 in. thick softwood or 0.75 inch. thick, 14 ply, arctic white birch (Finland form). Please note that plywood is not intended as a structural member, but only for prevention of local raveling (sloughing of the trench face) between shores.

(8) See appendix C for timber specifications.

(9) Wales are calculated for simple span conditions.

(10) See appendix D, item (d), for basis and limitations of the data.

ALUMINUM HYDRAULIC SHORING TYPICAL INSTALLATIONS

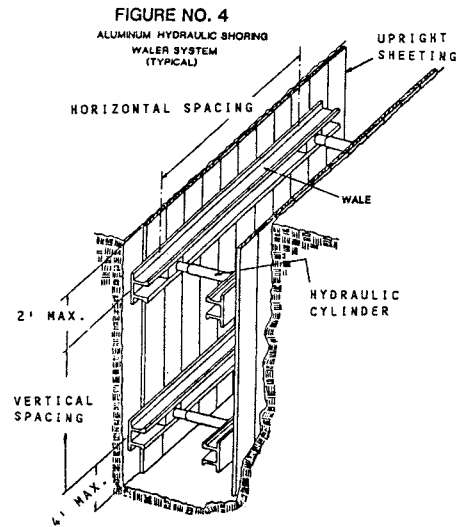
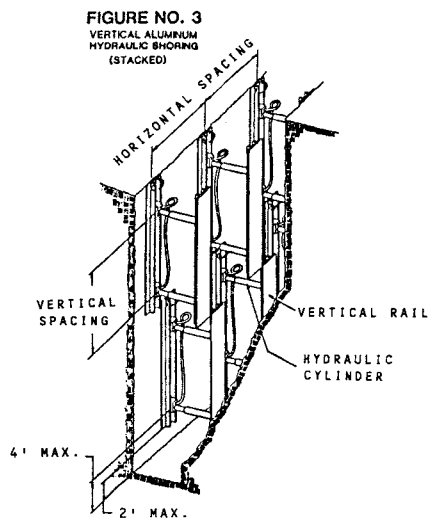
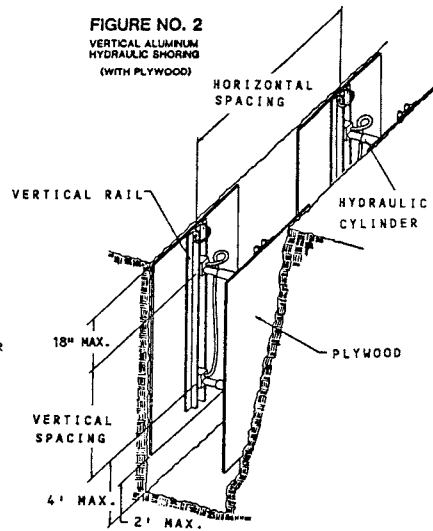
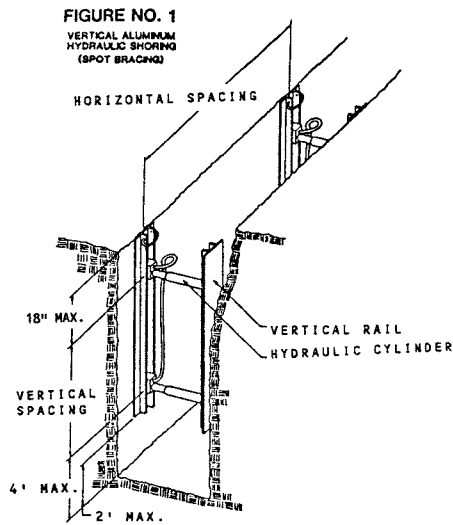

TABLE D - 1.1
ALUMINUM HYDRAULIC SHORING
VERTICAL SHORES
FOR SOIL TYPE A

DEPTH OF TRENCH (FEET)	HYDRAULIC CYLINDERS		
	MAXIMUM HORIZONTAL SPACING (FEET)	MAXIMUM VERTICAL SPACING (FEET)	WIDTH OF TRENCH (FEET)
OVER 5 UP TO 10	8	4	UP TO 8
OVER 10 UP TO 15	8		OVER 8 UP TO 12
OVER 15 UP TO 20	7		OVER 12 UP TO 15
OVER 20	NOTE (1)		

Footnotes to tables, and general notes on hydraulic shoring, are found in Appendix D, Item (g)

Note (1): See Appendix D, Item (g) (1)

Note (2): See Appendix D, Item (g) (2)

TABLE D - 1.2
ALUMINUM HYDRAULIC SHORING
VERTICAL SHORES
FOR SOIL TYPE B

DEPTH OF TRENCH (FEET)	HYDRAULIC CYLINDERS			MAXIMUM VERTICAL SPACING (FEET)	WIDTH OF TRENCH (FEET)		
	MAXIMUM HORIZONTAL SPACING (FEET)	UP TO 8	OVER 8 UP TO 12		OVER 12 UP TO 15		
OVER 5 UP TO 10	8						
OVER 10 UP TO 15	6.5			4	2 INCH DIAMETER	2 INCH DIAMETER NOTE (2)	3 INCH DIAMETER
OVER 15 UP TO 20	5.5						
OVER 20							

NOTE (1)

Footnotes to tables, and general notes on hydraulic shoring, are found in Appendix D, Item (g)

Note (1): See Appendix D, Item (g) (1)

Note (2): See Appendix D, Item (g) (2)

TABLE D - 1.3
ALUMINUM HYDRAULIC SHORING
WALER SYSTEMS
FOR SOIL TYPE B

DEPTH OF TRENCH (FEET)	WALES		HYDRAULIC CYLINDERS						TIMBER UPRIGHTS				
	VERTICAL SPACING (FEET)	SECTION MODULUS (IN ³) *	WIDTH OF TRENCH (FEET)						MAX. HORIZ. SPACING (ON CENTER)	SOLID SHEET	2 FT.	3 FT.	
			UP TO 8	OVER 8 UP TO 12	OVER 12 UP TO 15	OVER 8 UP TO 12		OVER 12 UP TO 15					
			HORIZ. SPACING	CYLINDER DIAMETER	HORIZ. SPACING	CYLINDER DIAMETER	HORIZ. SPACING	CYLINDER DIAMETER	HORIZ. SPACING	CYLINDER DIAMETER			
OVER 5 UP TO 10	4	3.5	8.0	2 IN	8.0	2 IN	8.0	3 IN	8.0	3 IN			
			9.0	2 IN	9.0	NOTE(2)	9.0	3 IN	9.0	3 IN			3x12
			12.0	3 IN	12.0	3 IN	12.0	3 IN	12.0	3 IN			
OVER 10 UP TO 15	4	3.5	6.0	2 IN	6.0	NOTE(2)	6.0	3 IN	6.0	3 IN			
			8.0	3 IN	8.0	3 IN	8.0	3 IN	8.0	3 IN			3x12
			10.0	3 IN	10.0	3 IN	10.0	3 IN	10.0	3 IN			
OVER 15 UP TO 20	4	3.5	5.5	2 IN	5.5	NOTE(2)	5.5	3 IN	5.5	3 IN			
			6.0	3 IN	6.0	3 IN	6.0	3 IN	6.0	3 IN			3x12
			9.0	3 IN	9.0	3 IN	9.0	3 IN	9.0	3 IN			
OVER 20			NOTE (1)										

Footnotes to tables, and general notes on hydraulic shoring, are found in Appendix D, Item (g)
 Notes (1): See Appendix D, item (g) (1)
 Notes (2): See Appendix D, Item (g) (2)
 * Consult product manufacturer and/or qualified engineer for Section Modulus of available wales.

TABLE D - 1.4
ALUMINUM HYDRAULIC SHORING
WALER SYSTEMS
FOR SOIL TYPE C

DEPTH OF TRENCH (FEET)	WALES		HYDRAULIC CYLINDERS						TIMBER UPRIGHTS		
	VERTICAL SPACING (FEET)	* SECTION MODULUS (IN ³)	WIDTH OF TRENCH (FEET)						MAX. HORIZ. SPACING (ON CENTER)	SOLID SHEET	
			UP TO 8	OVER 8 UP TO 12	OVER 12 UP TO 15	CYLINDER DIAMETER		2 FT.			3 FT.
OVER 5 UP TO 10	4	3.5	HORIZ. SPACING	6.0	6.0	6.0	2 IN	2 IN	3 IN	3x12	—
			CYLINDER DIAMETER	2 IN	2 IN	2 IN	NOTE(2)	NOTE(2)	3 IN		
			HORIZ. SPACING	6.5	6.5	6.5	NOTE(2)	NOTE(2)	3 IN		
OVER 10 UP TO 15	4	7.0	HORIZ. SPACING	10.0	10.0	10.0	3 IN	3 IN	3 IN	3x12	—
			CYLINDER DIAMETER	2 IN	2 IN	2 IN	NOTE(2)	NOTE(2)	3 IN		
			HORIZ. SPACING	4.0	4.0	4.0	NOTE(2)	NOTE(2)	3 IN		
OVER 15 UP TO 20	4	14.0	HORIZ. SPACING	5.5	5.5	5.5	3 IN	3 IN	3 IN	3x12	—
			CYLINDER DIAMETER	3 IN	3 IN	3 IN	NOTE(2)	NOTE(2)	3 IN		
			HORIZ. SPACING	8.0	8.0	8.0	3 IN	3 IN	3 IN		
OVER 20	4	3.5	HORIZ. SPACING	3.5	3.5	3.5	2 IN	2 IN	3 IN	3x12	—
			CYLINDER DIAMETER	2 IN	2 IN	2 IN	NOTE(2)	NOTE(2)	3 IN		
			HORIZ. SPACING	5.0	5.0	5.0	3 IN	3 IN	3 IN		
OVER 20											

NOTE (1)

Footnotes to tables, and general notes on hydraulic shoring, are found in Appendix D, Item (g)
Notes (1): See Appendix D, item (g) (1)
Notes (2): See Appendix D, item (g) (2)
* Consult product manufacturer and/or qualified engineer for Section Modulus of available wales.

APPENDIX E TO SUBPART P OF PART 1926—ALTERNATIVES TO TIMBER SHORING

Figure 1. Aluminum Hydraulic Shoring

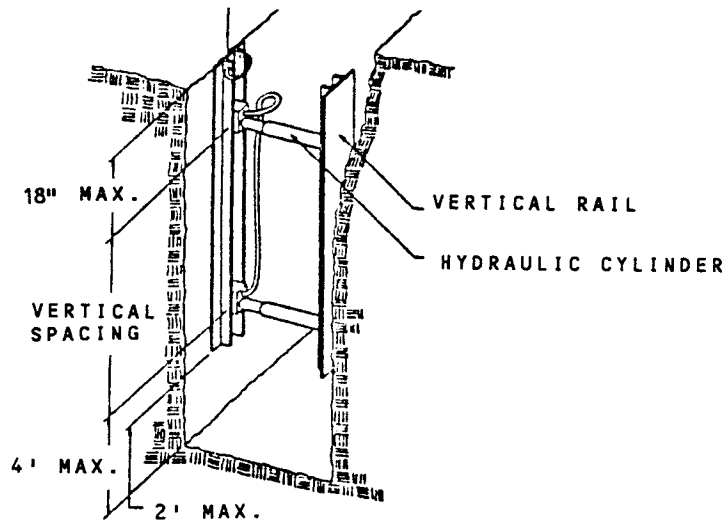

Figure 2. Pneumatic/hydraulic Shoring

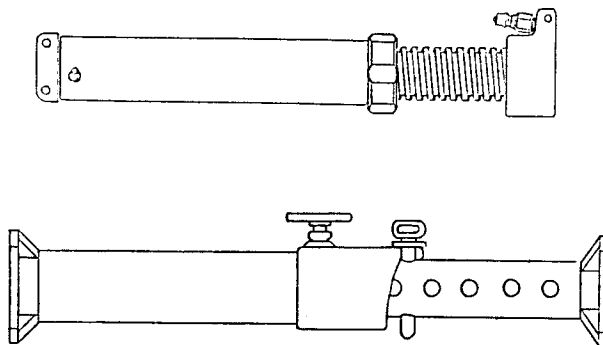

Figure 3. Trench Jacks (Screw Jacks)

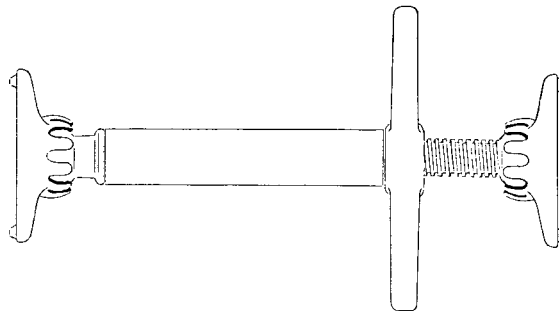
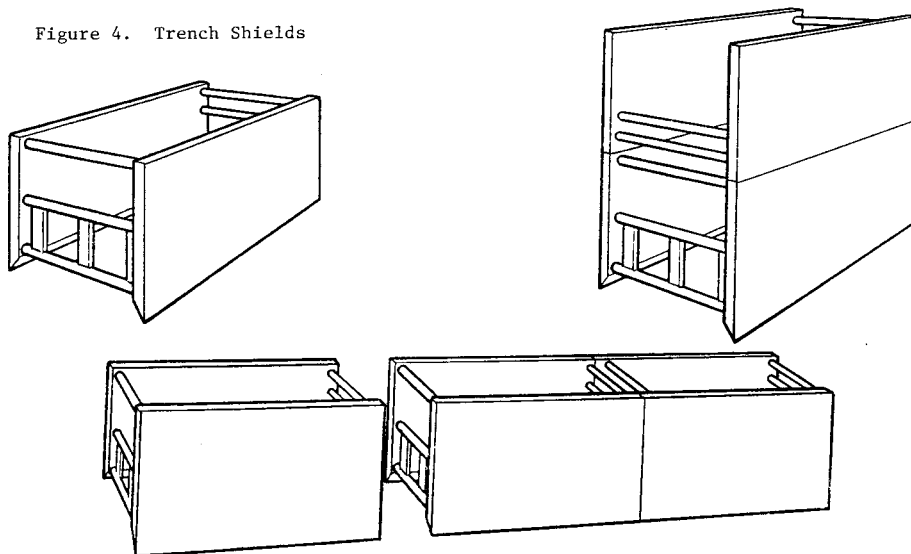

Figure 4. Trench Shields



APPENDIX F TO SUBPART P OF PART 1926—SELECTION OF PROTECTIVE SYSTEMS

The following figures are a graphic summary of the requirements contained in sub-

part P for excavations 20 feet or less in depth. Protective systems for use in excavations more than 20 feet in depth must be designed by a registered professional engineer in accordance with §1926.652 (b) and (c).

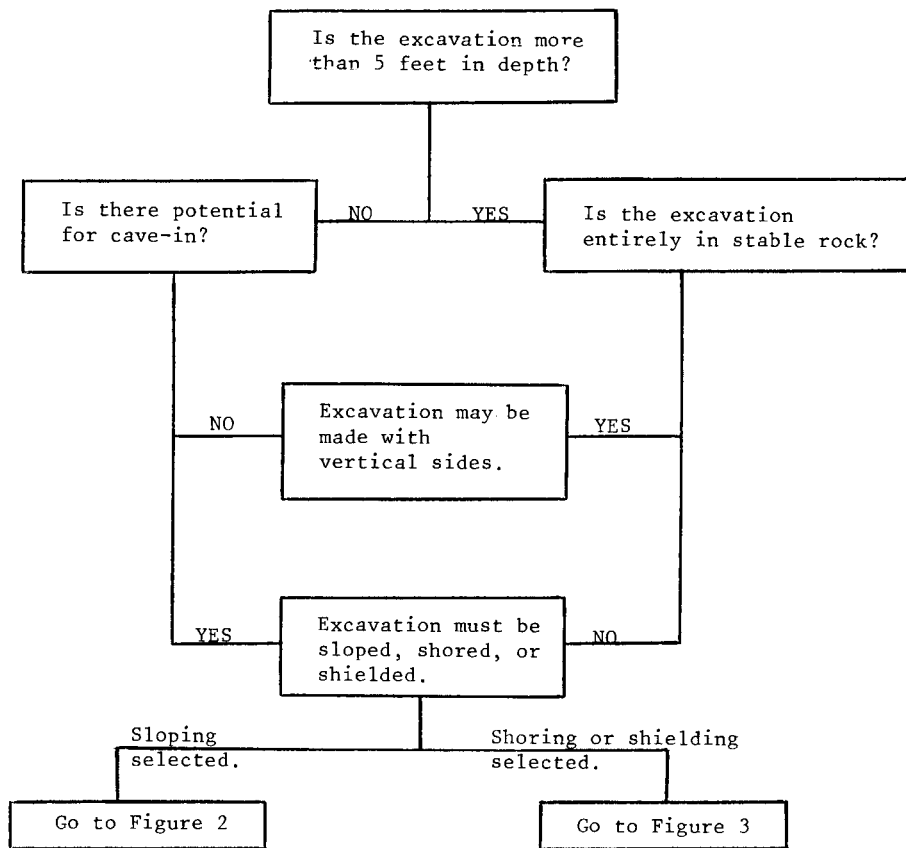

FIGURE 1 - PRELIMINARY DECISIONS

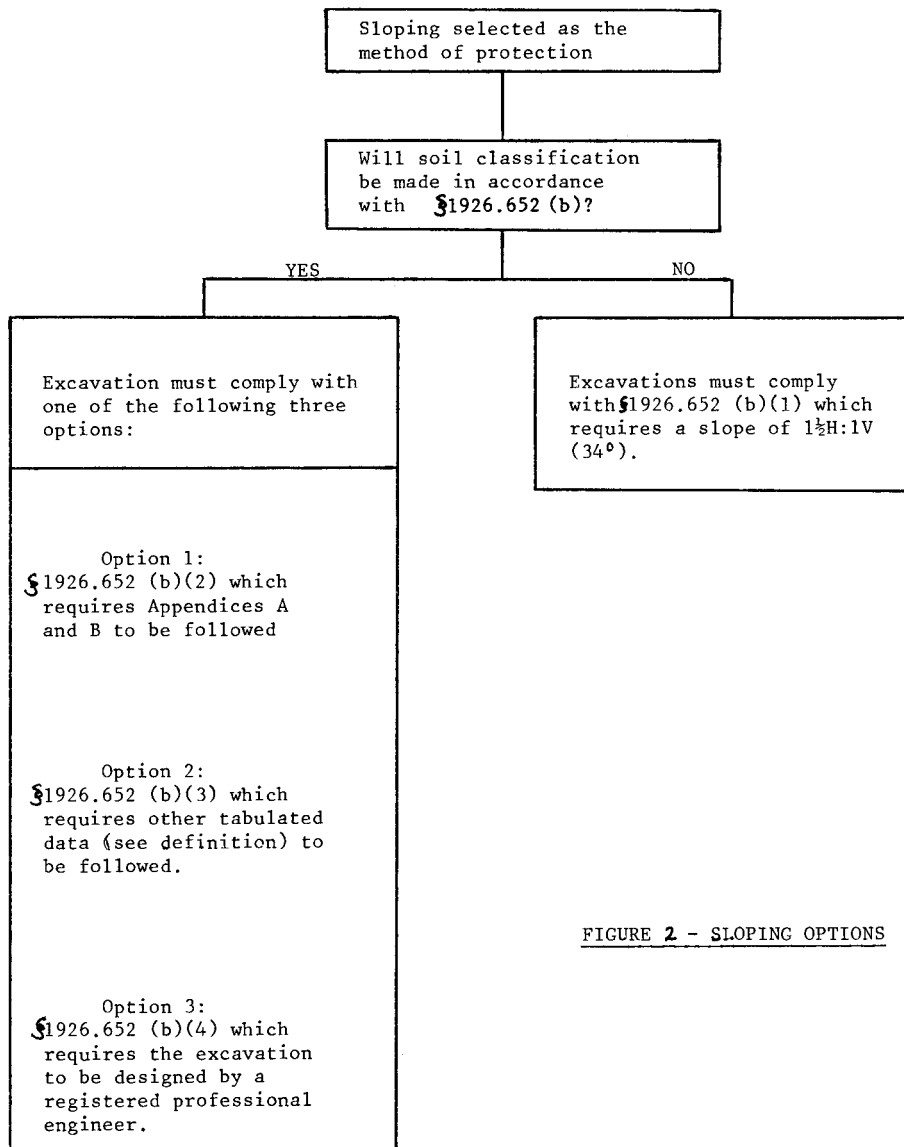

FIGURE 2 - SLOPING OPTIONS

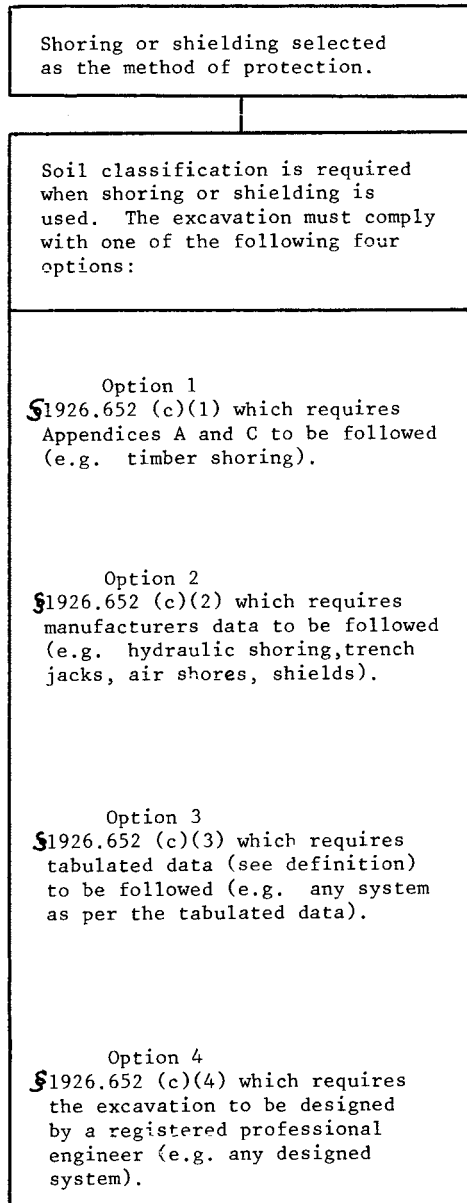

FIGURE 3 - SHORING AND SHIELDING OPTIONS

SECTION NO. 18

SPECIAL PROVISIONS - PAVEMENT MARKING SPECIFICATIONS

- A. Pavement markings shall include Reflectorized Pavement Markings, Prefabricated Pavement Markings, and Raised Pavement Markers and shall be in accordance with the Standard Specifications for Construction and Maintenance of Highways, Streets, and Bridges as published by the Texas Department of Transportation, latest edition. Contractor shall place markings in accordance with the surface condition, moisture, and temperature requirements.
- B. Reflectorized Pavement Markings that are considered the final and permanent markings shall be Type I "Hot Applied Thermoplastic, unless otherwise noted on the plans or approved by the City. Prefabricated pavement markings shall be placed in accordance with the manufacturer's specifications.
- C. Payment for pavement markings shall be lump sum as shown in the PROPOSAL.

END OF SECTION

SECTION NO. 20

SPECIAL PROVISIONS - SIGN SPECIFICATIONS

- A. Contractor shall furnish, fabricate, and erect sign assemblies consisting of the signs, sign supports, foundations, and associated mounting hardware in accordance with the City's details.
- B. Contractor shall remove and dispose of all existing signs, poles, and foundation; and furnish and install new signs as shown on the construction plans. All signs must meet current TMUTCD design and reflectivity requirements. Contractor shall prevent scarring and marring of poles and signs. Any damaged components shall be replaced with new material at the Contractors expense, as directed by the City.
- C. Payment shall be made in accordance with the lump sum bid item in the PROPOSAL.

END OF SECTION

SECTION NO. 22

SPECIAL PROVISIONS - MILL & OVERLAY/RECLAMATION SPECIFICATIONS

NUMERICAL LISTING

Section No.	
22-01	BASE FAILURE REPAIR
22-02	RECLAMATION
22-03	SURFACE, EDGE, AND BUTT MILLING
22-04	WARNING SIGNS FOR MILLED SURFACES
	SURFACE MILLING DETAILS
	EDGE MILLING DETAILS
	BUTT JOINT MILLING DETAIL

SECTION NO. 22

SPECIAL PROVISIONS - MILL & OVERLAY/RECLAMATION SPECIFICATIONS

22-01 BASE FAILURE REPAIR:

- A. All base failures will be repaired with Type "B" HMAC, or as specified by the City. Material will be placed and compacted in 4-inches lifts and shall be flush with the existing milled surface. Minimum depth is 8-inches and final depth will be achieved once solid subgrade is reached. Depth required for excavation of base failures will be determined by the City. Measurements for base failure repairs will be verified by the Contractor and the City at the end of each working day.
- B. Base failures that appear in front of citizen's driveways will be repaired the same day the street is milled. Base failures on the remainder of the road surface must be made safe for vehicular traffic the same day the street is milled until permanent repairs are made. Contractor must complete all base failures on each street within three (3) working days or a penalty of one thousand dollars (\$1,000) per day for each day in excess of the three (3) working days.
- C. On residential streets, Contractor will be required to use a mill, gradall type excavator or backhoe to excavate the base failure.
- D. Contractor shall immediately load excavated material into a truck. Excavated material shall not be placed on top of the milled surface at any time.
- E. Asphalt shall be delivered to the job site and placed in the prepared area for repair. Contractor shall not dump loads of asphalt in the street.
- F. Areas that require repair or asphalt reclamation will be determined by the City. If the City determines that more than thirty percent (30%) of the street has base failures, or determines that the weight of the excavation equipment will cause more than thirty percent (30%) of the street to fail, asphalt reclamation will be performed instead of a base failure repair.
- G. The City will pay for areas agreed upon by the Contractor and City.

22-02 RECLAMATION:

- A. It is the intent of the following specifications to establish provisions for restoration of selected HMAC streets. The reconstruction will consist of recycling the existing base and asphalt into a new base. The process is generally referred to as "Full Depth Reclamation". This specification may also be used for improved streets (with curb and gutter).
- B. GENERAL: This item consists of a subgrade composed of a combination of existing roadbed and HMAC, mixed with Lime and/or Portland Cement at amounts specified in the plans and/or Bid Items provided. The Recycled base shall be shaped to the line grades, thickness and typical cross-sections as directed by the City. The required thickness of compacted Recycled Stabilized Subgrade shall be 10-inches total with the lime being

mixed to a depth of 10-inches and the Cement being mixed to a depth of 8-inches for Residential & Collector streets.

C. MATERIALS:

1. Lime: Refer to Section 13-05 (Lime & Cement Treated Subgrade)
2. Cement: Refer to Section 13-06 (Cement Treated Subgrade)
3. Water: Water shall conform to the requirements of specification NCTCOG Item 303.2.7 thru 303.2.7.4.
4. HMAC: Refer to Section 13-22 (Hot Mix Asphaltic Concrete)
5. Petromat: Refer to Section 13-23 (Paving Fabric (Petromat))
6. Application Rates:
 - a. Typically, the existing material shall be scarified and pulverized to a target depth of 14-inches. The application rates shall be provided in the plans and/or PROPOSAL. If it is determined that the amount of lime and/or cement shown is deemed excessive by the City, it may be lowered based on results of an Atterburg Limits/Lime Series Test performed by the City's approved laboratory. No direct compensation will be given for lowering the amount of lime and/or cement used but compensation will be given at the unit price bid for the project if additional material is needed.
 - b. The profile of the recycled base will generally match the profile of the existing street. The ideal final cross-section, after resurfacing, when checked with a straightedge or stringline, shall have a 5-inches crown for Residential streets & a 7-inches crown for Collector streets and cul-de-sac (measured centerline to outside edges), shall be parabolic in shape, and shall have a smooth centerline joint.

C. EQUIPMENT:

1. General:

Equipment necessary for the proper construction of work shall be in safe and proper working condition, and shall be approved by the City, both as to type and condition, prior to the beginning of construction operations. All equipment shall have properly working and easily audible safety back-up alarms. The Contractor shall at all times provide sufficient equipment to ensure continuous execution of the work and its completion in the required number of working days. If in the opinion of the City, additional pieces of equipment are required for the mixing, aerating, compacting and finishing of the full depth reclamation mixture or to achieve a rate of progress which shall ensure completion of the work in time to restore traffic, the Contractor shall immediately secure and place in operation the required equipment. No additional compensation shall be granted for additional equipment utilized at the City's request.

2. Motor Grader

The use of motor grader for spreading/shaping recycled subgrade will be required.

3. Rollers

It shall be the responsibility of the Contractor to have rolling equipment available on the job to properly compact the Recycled/Stabilized Subgrade in place as required without delay of daily operations. A minimum of three (3) rollers, one of which will be pneumatic, shall be on the job at all times. Rollers provided shall meet the qualifications for their type as follows:

- a. Pneumatic-Tire Roller: The roller shall be an acceptable medium pneumatic tire roller conforming to the requirements of TxDOT Item 210 "ROLLING" unless otherwise specified on the plans. Pneumatic-tire rollers used for compaction shall be twelve (12) to twenty-five (25) ton.
- b. Vibratory Sheepsfoot Roller shall be thirty (30) Ton minimum.
- c. Vibrator Steel-Wheel Roller: This roller shall be a minimum of six (6) tons. The compactor shall be equipped with amplitude and frequency controls and shall be specifically designed to compact the material on which it is used. It shall be operated in accordance with the manufacturer's recommendations or as directed by the City.

4. Other Equipment

The Contractor shall furnish all other equipment required for the proper construction of the work. Prior to the beginning of construction, the Contractor shall provide a list of major equipment he intends to use stating the make, type, size, capacity and number of each piece of equipment. The approved list of additional equipment will include, but not be limited to the following:

- Water Truck
- Trucks
- Loader
- Backhoe
- Reclaimer
- Vacuum type sweeper

D. OPERATIONS:

The following sequence may vary however, each of the operational steps should be completed sometime during the recycling process.

1. Pulverize the surface asphalt and existing road base materials to the required depth.
2. Move the pulverized material by blading material placed in a windrow. Remove excess material to allow for determined street profile and cross-section for the required thickness of new HMA.

3. Inspection of the road sub-base to determine unsatisfactory conditions such as wet areas, soft spots, and other identified failures. Proof roll the sub-base to ensure no unsatisfactory sub-base areas occur.
4. Unsuitable sub-base areas shall be excavated and replaced with approved material as required to a depth not exceeding 3-feet to provide a uniform, firm, moist, compacted subgrade with ninety-five percent (95%) of density per ASTM D698, +/- two percent (2%) optimum moisture content.
5. All recycled asphalt, base, soil material to receive lime and/or cement stabilization shall receive an initial scarification to the bottom of the specified subgrade stabilization prior to application.
6. Proof roll the subgrade to ensure no unsatisfactory subgrade areas occur. Failing areas shall be re-stabilized at one hundred percent (100%) cement rate or be removed and replaced with cement treated base (CTB) at the City's discretion.
7. The finished recycled stabilized subgrade shall be continuously moist cured beginning immediately after completion of the lime and/or cement stabilization at no less than three (3) times daily, including holidays and weekends or as directed by the City. No direct compensation shall be given for moisture curing.
8. All Type "B" HMAC shall be laid within fourteen (14) days of initial pulverization.

Failure to observe the above sequence or time requirements may result in cessation of the work until proper adjustments in operations are made. No additional days will be compensated should adjustments be required.

- E. **MEASUREMENT AND PAYMENT:** The work performed will be paid for at the unit price bid as indicated in the PROPOSAL as measured in the field. The price shall be full compensation for preparing the subgrade as detailed in the specifications including scarifying, recycling, mixing, hauling, repair of sub-base failure, placing and compacting all materials and incidentals not otherwise specified necessary to complete the work in accordance with the intent of the plans and/or specifications. No additional compensation will be given for excavation & haul-off of additional material to establish grade, including but not limited to concrete, 2:27 or existing/unknown structures.

22-04 SURFACE, EDGE, AND BUTT MILLING:

- A. The existing surface on designated streets shall be milled to the depths and dimensions directed by the City. It is the intent to mill down to the original binder course or concrete base. This will include the milling of any and all existing asphalt surfaces, asphalt out of all curb and gutters, and valley gutters as directed by the City. All other milling work, not directed or authorized by the City, shall be considered incidental to the performance of the contract work and separate payment shall not be made for such work.

- B. Contractor shall mill only one side at a time. The other side shall not be milled until the initial side is completed, including any/or all temporary traffic items or as directed by the City.
- C. Normal milling operations shall be conducted to the edge of all manholes, valves and other appurtenances encountered. If the milling machine cannot accomplish this, then milling with hand tools or by other methods shall be used. No separate compensation shall be paid for any milling adjacent to appurtenances that is done with hand tools or by other methods.
- D. The milling machine shall self-load the milled material onto an adjacent hauling unit. Milling contract items will be bid on the basis that all milled material will be hauled and disposed of by the Contractor. Hauling of material shall be subsidiary to all other bid items in the PROPOSAL.
- E. Water shall be sprayed on the material being milled to eliminate dust during the milling operation. Sweeping to remove any loose material not removed by the machine shall be conducted immediately behind the machine in an approved manner to the satisfaction of the City. All milled surfaces shall be cleaned, inspected, measured and approved before the application of the HMAC.
- F. Normal operations shall require complete cleanup before the Contractor is allowed to leave the job. The Contractor **shall not** mill any street **more than seven (7) calendar days** in advance of scheduled resurfacing. When a street remains open, after milling, longer than seven (7) calendar days, in the absence of any required base repairs, any exposed surface that has deteriorated through traffic use, inclement weather, etc. shall be repaired and/or replaced, as directed by the City, at the Contractor's expense prior to any resurfacing. Failure to observe these constraints may result in cessation of the work until proper adjustments in operations are made.
- G. In no case shall the total milling work performed exceed the amount indicated in the PROPOSAL unless approved otherwise by the City. The Contractor shall be fully responsible for keeping a daily total for each item of milling work performed and shall cease all milling work should the total work reach the contract quantity. Payment for overruns shall be agreed upon and authorized by the City.
- H. Authorized Surface Milling & Butt Milling as defined by this specification, shall be measured for payment in square yards of surface milled regardless of the number of passes required. EDGE MILLING shall be paid for by the linear foot regardless of the number of passes necessary to provide the required width and section. The contract unit prices shall be the total compensation for milling the surface, removal and disposal of the milled material, cleaning the milled area, and for all labor, equipment, and incidentals necessary to complete the work in accordance with this provision, the specifications and attached details.
- I. Concrete butt milling is a separate pay item. Butt milling operations shall take place immediately before the asphalt paving operation or as approved by the City. Intersection(s) within the limits shall be butt milled as directed by the City.

- J. The unit prices for SURFACE MILLING, EDGE MILLING, and BUTT MILLING, will not be subject to renegotiation due to underrun or overrun of contract quantities.
- K. Milling operations shall include the removal of reinforcement steel, and other non-concrete items which may be exposed or subsequently stick up in the milled area. No separate pay item is provided for this rebar removal.
- L. The Contractor shall notify the City of Signal Control two (2) working days in advance of milling any street having traffic signals.

22-05 WARNING SIGNS FOR MILLED SURFACES:

- A. The Contractor will be responsible to submit a Traffic Control Plan in accordance with Section 12-03 Detours and Barricades.
- B. The Contractor shall erect and maintain suitable signs warning traffic of sharp edges from milling and exposed appurtenances.

Surface Milling Details

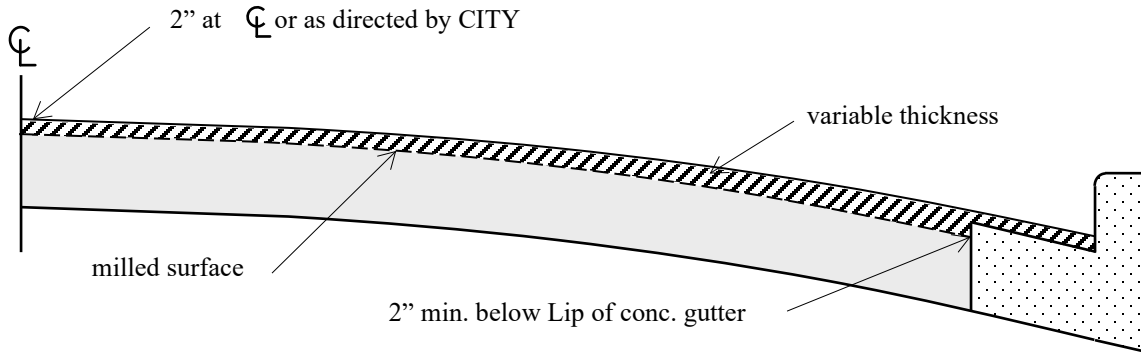

Surface Milling for Full Depth Asphalt Streets with Separate Concrete Curb and Gutter

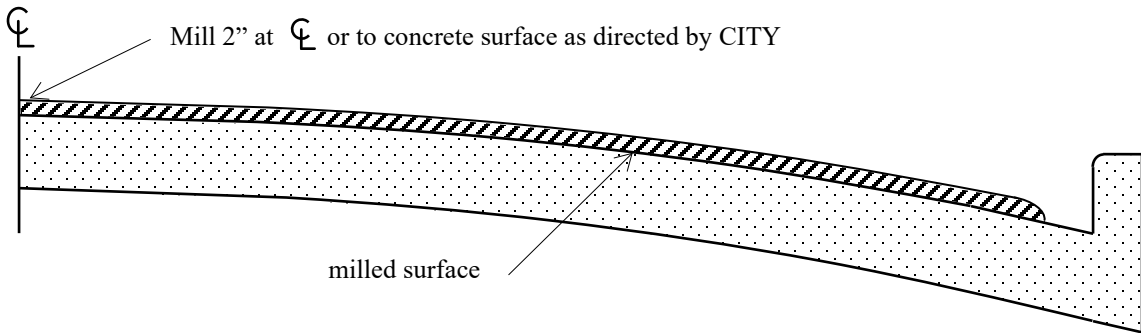

Surface Milling for Concrete Streets with Asphalt Overlay

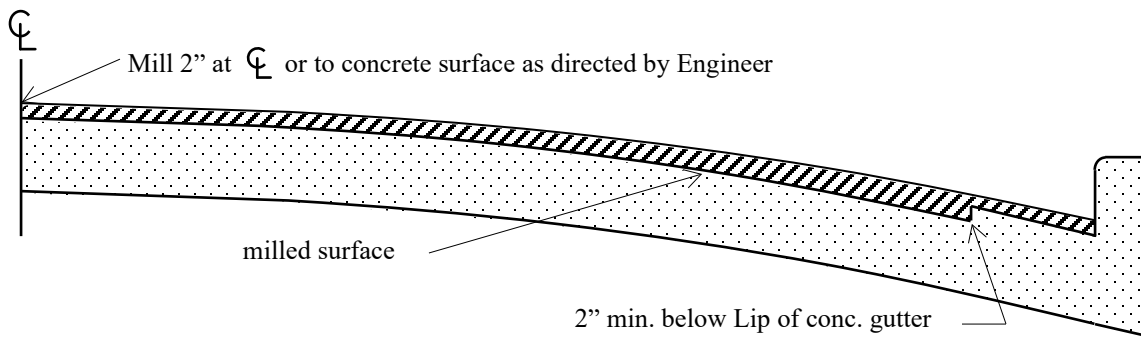

Surface Milling for Streets with Concrete base and Concrete Curb and Gutter

Edge Milling Details

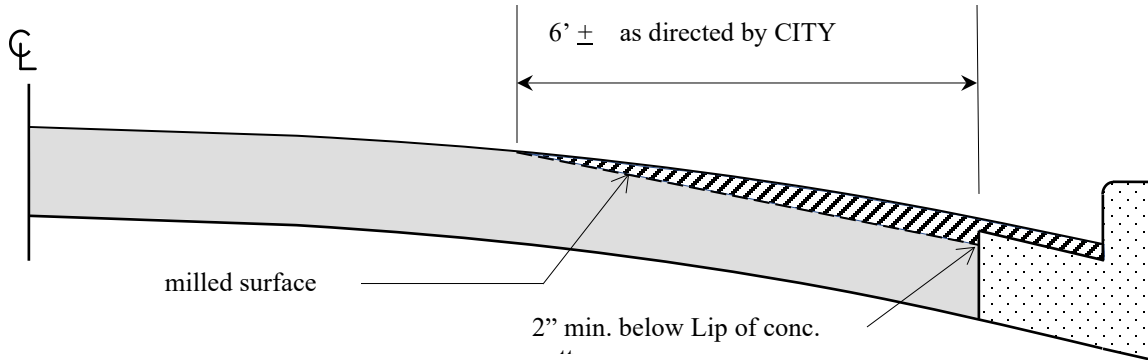

Edge Milling for Full Depth Asphalt Streets with Separate Concrete Curb and Gutter

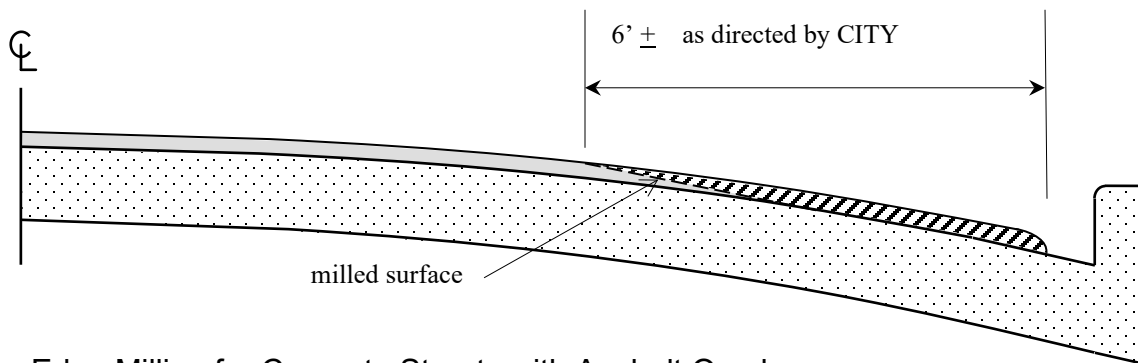

Edge Milling for Concrete Streets with Asphalt Overlay

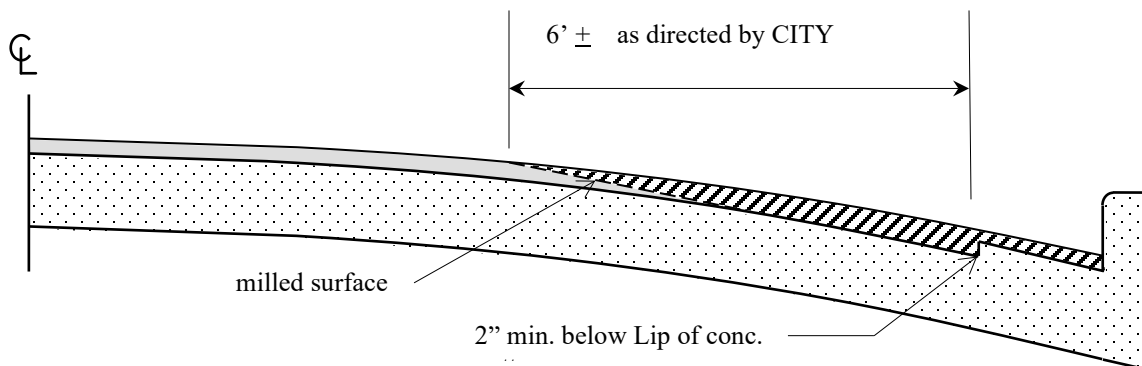

Edge Milling for Streets with Concrete base and Concrete Curb and Gutter

Butt Joint Milling Details

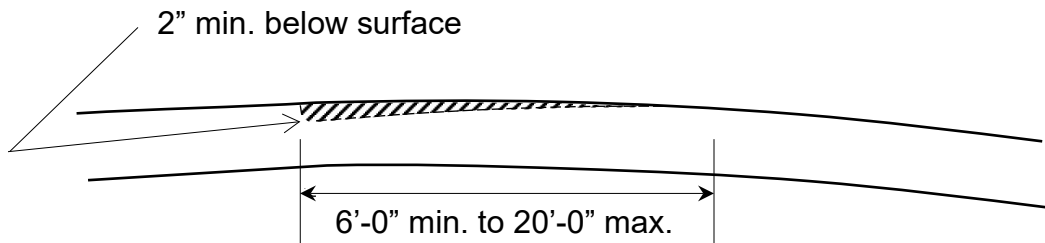
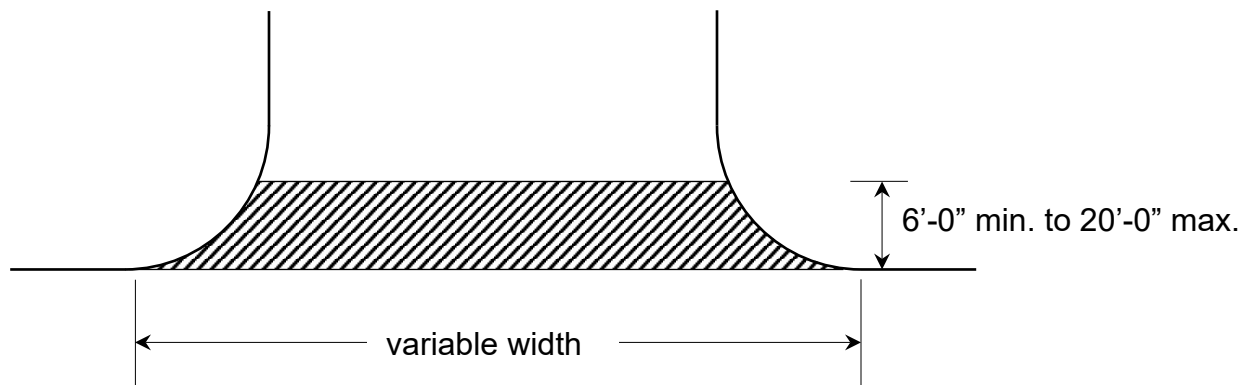
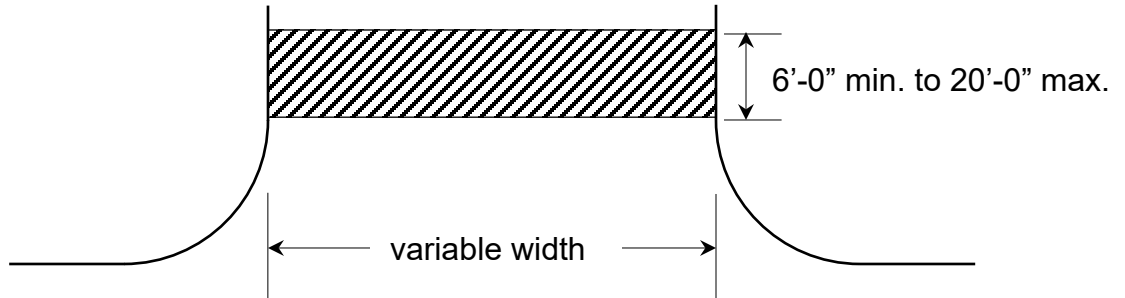

END OF SECTION